

### FEATURES

#### Analog Interface

140 MSPS Maximum Conversion Rate

330 MHz Analog Bandwidth

0.5 V to 1.0 V Analog Input Range

500 ps p-p PLL Clock Jitter at 140 MSPS

3.3 V Power Supply

Full Sync Processing

Midscale Clamp for YUV Applications

### GENERAL DESCRIPTION

The AD9886 is a complete 8-bit 140 MSPS monolithic analog interface optimized for capturing RGB graphics signals from personal computers and workstations. Its 140 MSPS encode rate capability and full-power analog bandwidth of 330 MHz supports resolutions up to SXGA (1280 × 1024 at 75 Hz).

For ease of design and to minimize cost, the AD9886 is a fully integrated interface solution for FPDs. The AD9886 includes a 140 MHz triple ADC with internal 1.25 V reference, PLL to generate a pixel clock from an HSYNC, and programmable gain, offset, and clamp control. The user provides only a 3.3 V power supply, analog input, and an HSYNC signal. Three-state CMOS outputs may be powered from 2.5 V to 3.3 V.

The AD9886's on-chip PLL generates a pixel clock from an HSYNC. Pixel clock output frequencies range from 12 MHz to 140 MHz. PLL clock jitter is 500 ps p-p typical at 140 MSPS. When the COAST signal is presented, the PLL maintains its output frequency in the absence of HSYNC. A sampling phase adjustment is provided. Data, HSYNC and Clock output phase relationships are maintained. The PLL can be disabled and an external clock input provided as the pixel clock. The AD9886 also offers full sync processing for composite sync and sync-on-green applications.

A clamp signal is generated internally or may be provided by the user through the CLAMP input pin. This interface is fully programmable via a 2-wire serial interface.

### FUNCTIONAL BLOCK DIAGRAM

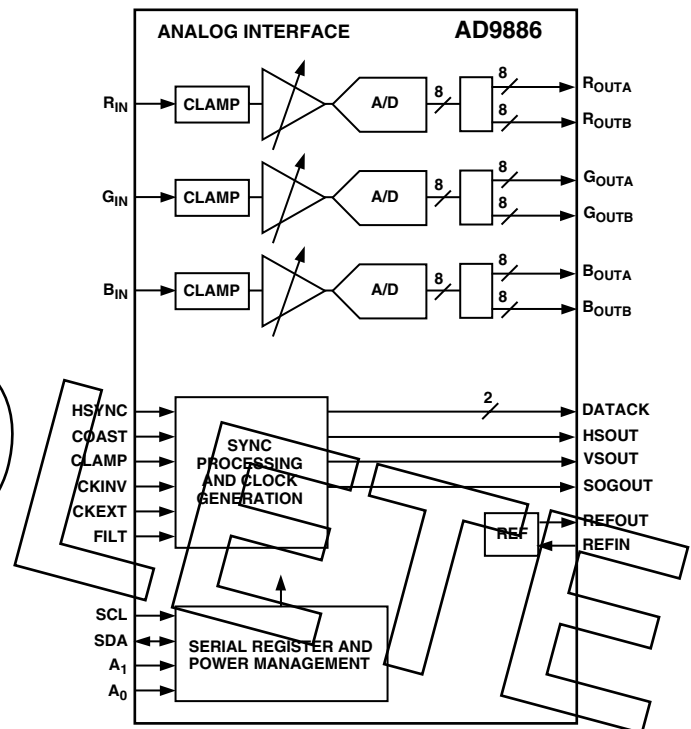

REV. 0

Information furnished by Analog Devices is believed to be accurate and reliable. However, no responsibility is assumed by Analog Devices for its use, nor for any infringements of patents or other rights of third parties which may result from its use. No license is granted by implication or otherwise under any patent or patent rights of Analog Devices.

# AD9886—SPECIFICATIONS ( $V_D = 3.3\text{ V}$ , $V_{DD} = 3.3\text{ V}$ , ADC Clock = Maximum Conversion Rate.)

Parameter	Temp	Test Level	AD9886KS-100			AD9886KS-140			Unit
			Min	Typ	Max	Min	Typ	Max	
RESOLUTION			8			8			Bits
DC ACCURACY									
Differential Nonlinearity	25°C	I		±0.5	+1.15/-1.0		±0.5	+1.25/-1.0	LSB
	Full	VI			+1.15/-1.0			+1.25/-1.0	LSB
Integral Nonlinearity	25°C	I		±0.5	±1.4		±0.5	±1.65	LSB
	Full	VI			±1.75			±2.5	LSB
No Missing Codes	Full	VI	Guaranteed			Guaranteed			
ANALOG INPUT									
Input Voltage Range									
Minimum	Full	VI			0.5			0.5	V p-p
Maximum	Full	VI	1.0			1.0			V p-p
Gain Tempco	25°C	V		135			150		ppm/°C
Input Bias Current	25°C	IV			1			1	µA
	Full	IV			1			1	µA
Input Offset Voltage	Full	VI		7	50		7	50	mV
Input Full-Scale Matching	Full	VI			8.0			8.0	% FS
Offset Adjustment Range	Full	VI	44	50	56	44	50	56	% FS
REFERENCE OUTPUT									
Output Voltage	Full	VI	1.20	1.25	1.30	1.20	1.25	1.30	V
Temperature Coefficient	Full	V		±50			±50		ppm/°C
SWITCHING PERFORMANCE <sup>1</sup>									
Maximum Conversion Rate	Full	VI	100			140			MSPS
Minimum Conversion Rate	Full	IV			10			10	MSPS
Data to Clock Skew, $t_{SKEW}$	Full	IV	-0.5		+2.0	-0.5		+2.0	ns
$t_{BUFF}$	Full	VI	4.7			4.7			µs
$t_{STAH}$	Full	VI	4.0			4.0			µs
$t_{DHO}$	Full	VI	0			0			µs
$t_{DAL}$	Full	VI	4.7			4.7			µs
$t_{DAH}$	Full	VI	4.0			4.0			µs
$t_{DSU}$	Full	VI	250			250			µs
$t_{STASU}$	Full	VI	4.7			4.7			µs
$t_{STOSU}$	Full	VI	4.0			4.0			µs
HSYNC Input Frequency	Full	IV	15		110	15		110	kHz
Maximum PLL Clock Rate	Full	VI	100			140			MHz
Minimum PLL Clock Rate	Full	IV			12			12	MHz
PLL Jitter	25°C	IV		400	700 <sup>2</sup>		400	700 <sup>3</sup>	ps p-p
	Full	IV			1000 <sup>2</sup>			1000 <sup>3</sup>	ps p-p
Sampling Phase Tempco	Full	IV		15			15		ps/°C
DIGITAL INPUTS									
Input Voltage, High ( $V_{IH}$ )	Full	VI	2.5			2.5			V
Input Voltage, Low ( $V_{IL}$ )	Full	VI			0.8			0.8	V
Input Current, High ( $I_{IH}$ )	Full	IV			-1.0			-1.0	µA
Input Current, Low ( $I_{IL}$ )	Full	IV			1.0			1.0	µA
Input Capacitance	25°C	V	3			3			pF
DIGITAL OUTPUTS									
Output Voltage, High ( $V_{OH}$ )	Full	VI	$V_D - 0.1$			$V_D - 0.1$			V
Output Voltage, Low ( $V_{OL}$ )	Full	VI			0.1			0.1	V
Duty Cycle									
DATAACK, $\overline{\text{DATAACK}}$	Full	IV	45	50	55	45	50	55	%
Output Coding			Binary			Binary			

Parameter	Temp	Test Level	AD9886KS-100			AD9886KS-140			Unit
			Min	Typ	Max	Min	Typ	Max	
<b>POWER SUPPLY</b>									
V <sub>D</sub> Supply Voltage	Full	IV	3.0	3.3	3.6	3.0	3.3	3.6	V
V <sub>DD</sub> Supply Voltage	Full	IV	2.2	3.3	3.6	2.2	3.3	3.6	V
P <sub>VD</sub> Supply Voltage	Full	IV	3.0	3.3	3.6	3.0	3.3	3.6	V
I <sub>D</sub> Supply Current (V <sub>D</sub> )	25°C	V		140			155		mA
I <sub>DD</sub> Supply Current (V <sub>DD</sub> ) <sup>4</sup>	25°C	V		34			48		mA
I <sub>PVD</sub> Supply Current (P <sub>VD</sub> )	25°C	V		15			16		mA
Total Power Dissipation	Full	VI		564	850		715	850	mW
Power-Down Supply Current	Full	VI		13	25		13	25	mA
Power-Down Dissipation	Full	VI		43	82.5		43	82.5	mW
<b>DYNAMIC PERFORMANCE</b>									
Analog Bandwidth, Full Power	25°C	V		330			330		MHz
Transient Response	25°C	V		2			2		ns
Overvoltage Recovery Time	25°C	V		1.5			1.5		ns
Signal-to-Noise Ratio (SNR) <sup>5</sup> (Without Harmonics)	25°C	V		46			46		dB
f <sub>IN</sub> = 40.7 MHz	Full	V		45			45		dB
Crosstalk	Full	V		60			60		dBc
<b>THERMAL CHARACTERISTICS</b>									
θ <sub>JC</sub> Junction-to-Case Thermal Resistance	V			20			20		°C/W
θ <sub>JA</sub> Junction-to-Ambient Thermal Resistance	V			40			40		°C/W

## NOTES

<sup>1</sup>Drive Strength = 11.<sup>2</sup>VCO Range = 01, Charge Pump Current = 001, PLL Divider = 1693.<sup>3</sup>VCO Range = 10, Charge Pump Current = 110, PLL Divider = 1600.<sup>4</sup>DEMUX = 1, DATAACK and DATAACK Load = 10 pF, Data Load = 5 pF.<sup>5</sup>Using external pixel clock.

Specifications subject to change without notice.

# AD9886

## ABSOLUTE MAXIMUM RATINGS\*

V <sub>D</sub> .....	3.6 V
V <sub>DD</sub> .....	3.6 V
Analog Inputs .....	V <sub>D</sub> to 0.0 V
VREF IN .....	V <sub>D</sub> to 0.0 V
Digital Inputs .....	5 V to 0.0 V
Digital Output Current .....	20 mA
Operating Temperature .....	-25°C to +85°C
Storage Temperature .....	-65°C to +150°C
Maximum Junction Temperature .....	175°C
Maximum Case Temperature .....	150°C

\*Stresses above those listed under Absolute Maximum Ratings may cause permanent damage to the device. This is a stress rating only; functional operation of the device at these or any other conditions outside of those indicated in the operation sections of this specification is not implied. Exposure to absolute maximum ratings for extended periods may affect device reliability.

## EXPLANATION OF TEST LEVELS

### Test Level

- I 100% production tested.
- II 100% production tested at 25°C and sample tested at specified temperatures.
- III Sample tested only.
- IV Parameter is guaranteed by design and characterization testing.
- V Parameter is a typical value only.
- VI 100% production tested at 25°C; guaranteed by design and characterization testing.

## ORDERING GUIDE

Model	Temperature Range	Package Description	Package Option
AD9886KS-140	0°C to 70°C	Plastic Quad Flatpack	S-160
AD9886KS-100	0°C to 70°C	Plastic Quad Flatpack	S/160
AD9886/PCB	25°C	Evaluation Board	

## CAUTION

ESD (electrostatic discharge) sensitive device. Electrostatic charges as high as 4000 V readily accumulate on the human body and test equipment and can discharge without detection. Although the AD9886 features proprietary ESD protection circuitry, permanent damage may occur on devices subjected to high-energy electrostatic discharges. Therefore, proper ESD precautions are recommended to avoid performance degradation or loss of functionality.



PIN CONFIGURATION

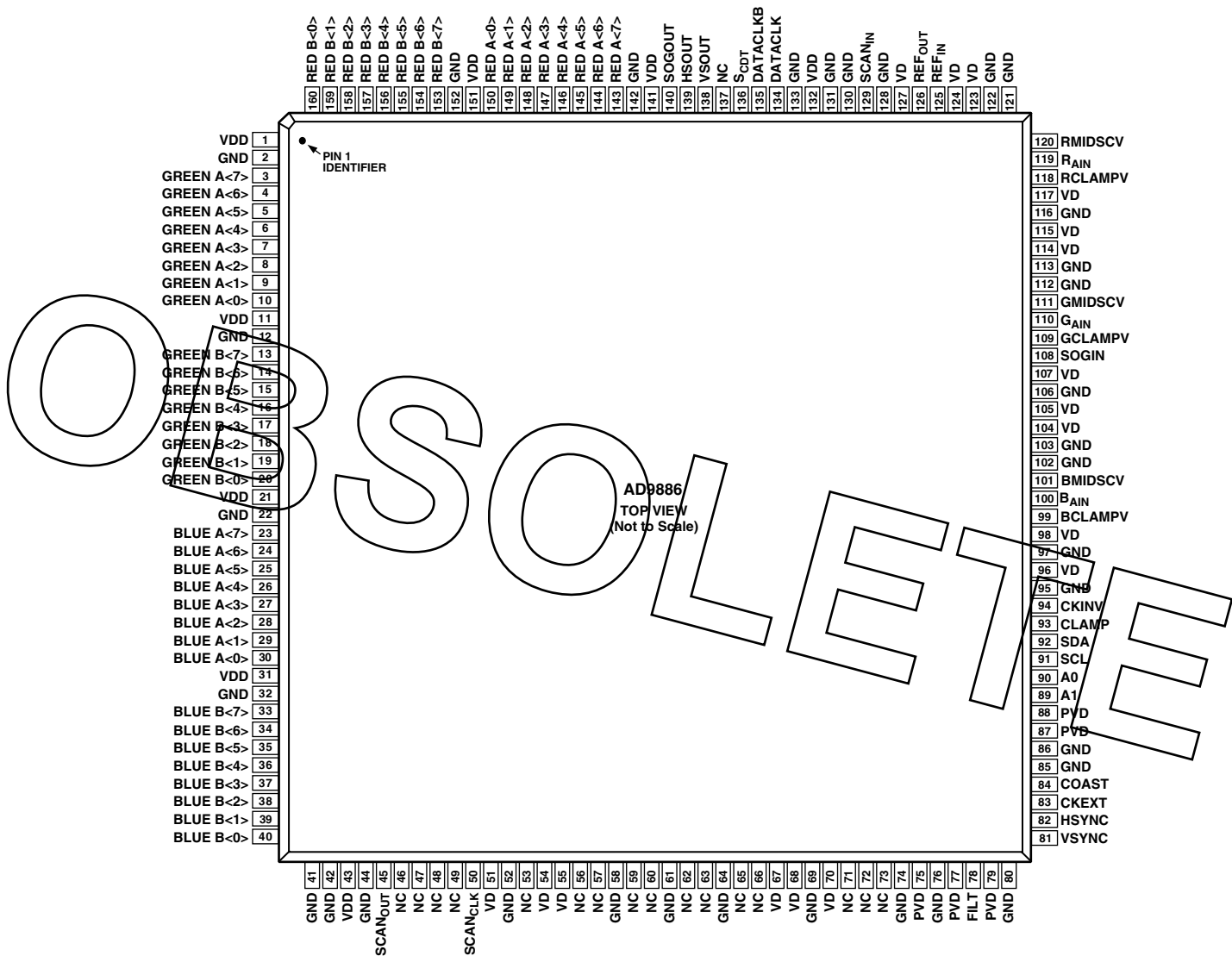

NC = NO CONNECT

Table I. Complete Pinout List

Pin Type	Pin Name	Function	Value	Pin Number
Analog Video Inputs	R <sub>AIN</sub>	Analog Input for Converter R	0.0 V to 1.0 V	119
	G <sub>AIN</sub>	Analog Input for Converter G	0.0 V to 1.0 V	110
	B <sub>AIN</sub>	Analog Input for Converter B	0.0 V to 1.0 V	100
External Sync/Clock Inputs	HSYNC	Horizontal SYNC Input	3.3 V CMOS	82
	VSYNC	Vertical SYNC Input	3.3 V CMOS	81
	SOGIN	Input for Sync-on-Green	0.0 V to 1.0 V	108
	CLAMP	Clamp Input (External CLAMP Signal)	3.3 V CMOS	93
	COAST	PLL COAST Signal Input	3.3 V CMOS	84
	CKEXT	External Pixel Clock Input (to Bypass the PLL) or 10 k $\Omega$ to V <sub>DD</sub>	3.3 V CMOS	83
	CKINV	ADC Sampling Clock Invert	3.3 V CMOS	94
Sync Outputs	HSOUT	HSYNC Output Clock (Phase-Aligned with DATAACK)	3.3 V CMOS	139
	VSOUT	VSYNC Output Clock (Phase-Aligned with DATAACK)	3.3 V CMOS	138
	SOGOUT	Sync on Green Slicer Output	3.3 V CMOS	140
Voltage Reference	REFOUT	Internal Reference Output (Bypass with 0.1 $\mu$ F to Ground)	1.25 V	126
	REFIN	Reference Input (1.25 V $\pm$ 10%)	1.25 $\pm$ 10%	125
Clamp Voltages	R <sub>MIDSC</sub> V	Red Channel Midscale Clamp Voltage Output		120
	R <sub>CLAMP</sub> V	Red Channel Midscale Clamp Voltage Output	0.0 V to 0.75 V	118
	G <sub>MIDSC</sub> V	Green Channel Midscale Clamp Voltage Output		111
	G <sub>CLAMP</sub> V	Green Channel Midscale Clamp Voltage Output	0.0 V to 0.75 V	109
	B <sub>MIDSC</sub> V	Blue Channel Midscale Clamp Voltage Output		101
	B <sub>CLAMP</sub> V	Blue Channel Midscale Clamp Voltage Output	0.0 V to 0.75 V	99
PLL Filter	FILT	Connection for External Filter Components for Internal PLL		78
Power Supply	V <sub>D</sub>	Analog Power Supply	3.3 V $\pm$ 10%	
	V <sub>DD</sub>	Output Power Supply	3.3 V $\pm$ 10%	
	PV <sub>D</sub>	PLL Power Supply	3.3 V $\pm$ 10%	
	GND	Ground	0 V	
Serial Port (2-Wire Serial Interface)	SDA	Serial Port Data I/O	3.3 V CMOS	92
	SCL	Serial Port Data Clock (100 kHz max)	3.3 V CMOS	91
	A0	Serial Port Address Input 1	3.3 V CMOS	90
	A1	Serial Port Address Input 2	3.3 V CMOS	89
Data Outputs	Red B[7:0]	Port B/Odd Outputs of Converter "Red," Bit 7 Is the MSB	3.3 V CMOS	153–160
	Green B[7:0]	Port B/Odd Outputs of Converter "Green," Bit 7 Is the MSB	3.3 V CMOS	13–20
	Blue B[7:0]	Port B/Odd Outputs of Converter "Blue," Bit 7 Is the MSB	3.3 V CMOS	33–40
	Red A[7:0]	Port A/Even Outputs of Converter "Red," Bit 7 Is the MSB	3.3 V CMOS	143–150
	Green A[7:0]	Port A/Even Outputs of Converter "Green," Bit 7 Is the MSB	3.3 V CMOS	3–10
	Blue A[7:0]	Port A/Even Outputs of Converter "Blue," Bit 7 Is the MSB	3.3 V CMOS	23–30
Data Clock Outputs	DATAACK	Data Output Clock for the Analog and Digital Interface	3.3 V CMOS	134
	$\overline{\text{DATAACK}}$	Data Output Clock Complement for the Analog Interface Only	3.3 V CMOS	135
Sync Detect	S <sub>CDT</sub>	Sync Detect Output	3.3 V CMOS	136
Scan Function	SCAN <sub>IN</sub>	Input for SCAN Function	3.3 V CMOS	129
	SCAN <sub>OUT</sub>	Output for SCAN Function	3.3 V CMOS	45
	SCAN <sub>CLK</sub>	Clock for SCAN Function	3.3 V CMOS	50
No Connect	NC	These Pins Should be Left Unconnected		46–49, 53, 56, 57, 59, 60, 62, 63, 65, 66, 71–73, 137

## PIN FUNCTION DETAIL

## Inputs

**R<sub>AIN</sub>** Analog Input for RED Channel

**G<sub>AIN</sub>** Analog Input for GREEN Channel

**B<sub>AIN</sub>** Analog Input for BLUE Channel

High-impedance inputs that accept the RED, GREEN, and BLUE channel graphics signals, respectively. (The three channels are identical and can be used for any colors, but colors are assigned for convenient reference.)

They accommodate input signals ranging from 0.5 V to 1.0 V full scale. Signals should be ac-coupled to these pins to support clamp operation.

**HSYNC**

## Horizontal Sync Input

This input receives a logic signal that establishes the horizontal timing reference and provides the frequency reference for pixel clock generation.

The logic sense of this pin is controlled by serial register 0Fh Bit 7 (HSYNC Polarity). Only the leading edge of HSYNC is active; the trailing edge is ignored. When HSYNC Polarity = 0, the falling edge of HSYNC is used. When HSYNC Polarity = 1, the rising edge is active.

The input includes a Schmitt trigger for noise immunity, with a nominal input threshold of 1.5 V.

Electrostatic Discharge (ESD) protection diodes will conduct heavily if this pin is driven more than 0.5 V above the maximum tolerance voltage (3.3 V), or more than 0.5 V below ground.

**VSYNC**

## Vertical Sync Input

This is the input for vertical sync.

**SOGIN**

## Sync-on-Green Input

This input is provided to assist with processing signals with embedded sync, typically on the GREEN channel. The pin is connected to a high-speed comparator with an internally generated threshold, which is set to 0.15 V above the negative peak of the input signal.

When connected to an ac-coupled graphics signal with embedded sync, it will produce a noninverting digital output on SOGOUT. (This is usually a composite sync signal, containing both vertical and horizontal sync information that must be separated before passing the horizontal sync signal to HSYNC).

When not used, this input should be left unconnected. For more details on this function and how it should be configured, refer to the Sync on Green section.

**CLAMP**

## External Clamp Input

This logic input may be used to define the time during which the input signal is clamped to the reference dc level (ground for RGB or midscale for YUV). It should be exercised when the reference dc level is known to be present on the analog input channels, typically during the back porch of the graphics signal. The CLAMP pin is enabled by setting control bit EXTCLMP to 1 (the default power-up is 0). When disabled, this pin is ignored and the clamp timing is determined internally by counting a delay and duration from the trailing edge of the HSYNC input. The logic sense of this pin is controlled by CLAMPOL. When not used, this pin must be grounded and EXTCLMP programmed to 0.

## Clock Generator Coast Input (Optional)

This input may be used to cause the pixel clock generator to stop synchronizing with HSYNC and continue producing a clock at its current frequency and phase. This is useful when processing signals from sources that fail to produce horizontal sync pulses when in the vertical interval. The COAST signal is generally *not* required for PC-generated signals.

The logic sense of this pin is controlled by COAST Polarity.

When not used, this pin may be grounded and COAST Polarity programmed to 1, or tied HIGH (to V<sub>D</sub> through a 10/kΩ resistor) and COAST Polarity programmed to 0. COAST Polarity defaults to 1 at power-up.

**COAST****CKEXT**

## External Clock Input (Optional)

This pin may be used to provide an external clock to the AD9886, in place of the clock internally generated from HSYNC.

It is enabled by programming EXTCLK to 1. When an external clock is used, all other internal functions operate normally. When unused, this pin should be tied through a 10 kΩ resistor to GROUND, and EXTCLK programmed to 0. The clock phase adjustment still operates when an external clock source is used.

**CKINV**

## Sampling Clock Inversion (Optional)

This pin may be used to invert the pixel sampling clock, which has the effect of shifting the sampling phase 180°. This is in support of Alternate Pixel Sampling mode, wherein higher-frequency input signals (up to 280 Mpps) may be captured by first sampling the odd pixels, then capturing the even pixels on the subsequent frame.

This pin should be exercised only during blanking intervals (typically vertical blanking) as it may produce several samples of corrupted data during the phase shift.

CKINV should be grounded when not used.

# AD9886

## Outputs

D <sub>RA</sub> 7-0	Data Output, Red Channel, Port A
D <sub>RB</sub> 7-0	Data Output, Red Channel, Port B
D <sub>GA</sub> 7-0	Data Output, Green Channel, Port A
D <sub>GB</sub> 7-0	Data Output, Green Channel, Port B
D <sub>BA</sub> 7-0	Data Output, Blue Channel, Port A
D <sub>BB</sub> 7-0	Data Output, Blue Channel, Port B

These are the main data outputs. Bit 7 is the MSB.

Each channel has two ports. When the part is operated in single-channel mode (DEMUX = 0), all data are presented to Port A, and Port B is placed in a high-impedance state.

Programming DEMUX to 1 established dual-channel mode, wherein alternate pixels are presented to Port A and Port B of each channel. These will appear simultaneously, two pixels presented at the time of every second input pixel, when PAR is set to 1 (parallel mode). When PAR = 0, pixel data appear alternately on the two ports, one new sample with each incoming pixel (interleaved mode).

In dual channel mode, the first pixel after HSYNC is routed to Port A. The second pixel goes to Port B, the third to A, etc. This can be reversed by setting OUTPHASE to 1.

The delay from pixel sampling time to output is fixed. When the sampling time is changed by adjusting the PHASE register, the output timing is shifted as well. The DATAACK,  $\overline{\text{DATAACK}}$ , and HSOUT outputs are also moved, so the timing relationship among the signals is maintained.

DATAACK

Data Output Clock

$\overline{\text{DATAACK}}$

Data Output Clock Complement

Differential data clock output signals to be used to strobe the output data and HSOUT into external logic.

They are produced by the internal clock generator and are synchronous with the internal pixel sampling clock.

When the AD9886 is operated in single-channel mode, the output frequency is equal to the pixel sampling frequency. When operating in dual channel mode, the clock frequency is one-half the pixel frequency, as is the output data frequency.

When the sampling time is changed by adjusting the PHASE register, the output timing is shifted as well. The Data, DATAACK,  $\overline{\text{DATAACK}}$ , and HSOUT outputs are all moved, so the timing relationship among the signals is maintained.

Either or both signals may be used, depending on the timing mode and interface design employed.

HSOUT

Horizontal Sync Output

A reconstructed and phase-aligned version of the Hsync input. Both the polarity and duration of this output can be programmed via serial bus registers.

By maintaining alignment with DATAACK,  $\overline{\text{DATAACK}}$ , and Data, data timing with respect to horizontal sync can always be determined.

SOGOUT

Sync-On-Green Slicer Output

This pin can be programmed to output either the output from the Sync-On-Green slicer comparator or an unprocessed but delayed version of the HSYNC input. See the Sync Block Diagram to view how this pin is connected.

(Note: Besides slicing off SOG, the output from this pin receives no additional processing on the AD9886. VSYNC separation is performed via the sync separator.)

REFOUT

Internal Reference Output

Output from the internal 1.25 V bandgap reference. This output is intended to drive relatively light loads. It can drive the AD9886 Reference Input directly, but should be externally buffered if it is used to drive other loads as well.

The absolute accuracy of this output is  $\pm 4\%$ , and the temperature coefficient is  $\pm 50$  ppm, which is adequate for most AD9886 applications. If higher accuracy is required, an external reference may be employed instead.

If an external reference is used, connect this pin to ground through a 0.1  $\mu\text{F}$  capacitor.

REFIN

Reference Input

The reference input accepts the master reference voltage for all AD9886 internal circuitry (1.25 V  $\pm 10\%$ ). It may be driven directly by the REFOUT pin. Its high impedance presents a very light load to the reference source.

This pin should always be bypassed to Ground with a 0.1  $\mu\text{F}$  capacitor.

FILT

External Filter Connection

For proper operation, the pixel clock generator PLL requires an external filter. Connect the filter shown Figure 7 to this pin. For optimal performance, minimize noise and parasitics on this node.



**Power Supply**

**V<sub>D</sub>** Main Power Supply  
 These pins supply power to the main elements of the circuit. It should be as quiet and filtered as possible.

**V<sub>DD</sub>** Digital Output Power Supply  
 A large number of output pins (up to 52) switching at high speed (up to 140 MHz) generates a lot of power supply transients (noise). These supply pins are identified separately from the V<sub>D</sub> pins so special care can be taken to minimize output noise transferred into the sensitive analog circuitry.

If the AD9886 is interfacing with lower-voltage logic, V<sub>DD</sub> may be connected to a lower supply voltage (as low as 2.5 V) for compatibility.

**Clock Generator Power Supply**

The most sensitive portion of the AD9886 is the clock generation circuitry. These pins provide power to the clock PLL and help the user design for optimal performance. The designer should provide "quiet," noise-free power to these pins.

**GND** Ground

The ground return for all circuitry on chip. It is recommended that the AD9886 be assembled on a single solid ground plane, with careful attention to ground current paths.

**Serial Port (Two-Wire)**

**SDA** Serial Port Data I/O  
**SCL** Serial Port Data Clock  
**A0** Serial Port Address Input 1  
**A1** Serial Port Address Input 2  
 For a full description of the 2-wire serial register and how it works, refer to the Control Register section.

**SCAN Function**

**SCAN<sub>IN</sub>** Data Input for SCAN Function  
 Data can be loaded serially into the 48-bit SCAN register through this pin, clocking it in with the SCAN<sub>CLK</sub> pin. It then comes out of the 48 data outputs in parallel. This function is useful for loading known data into a graphics controller chip for testing purposes.

**SCAN<sub>OUT</sub>** Data Output for SCAN Function  
 The data in the 48-bit SCAN register can be read through this pin. Data is read on a FIFO basis and is clocked via the SCAN<sub>CLK</sub> pin.

**SCAN<sub>CLK</sub>** Data Clock for SCAN Function  
 This pin clocks the data through the SCAN register. It controls both data input and data output.

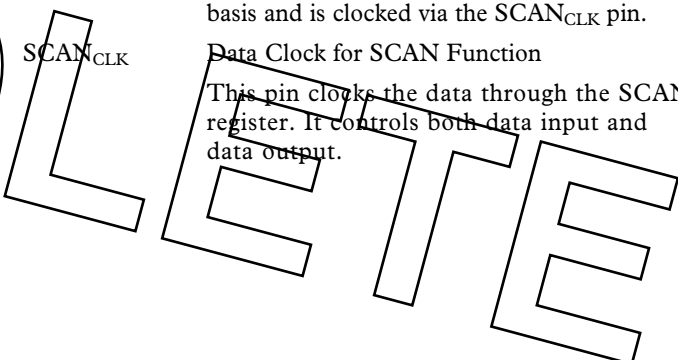
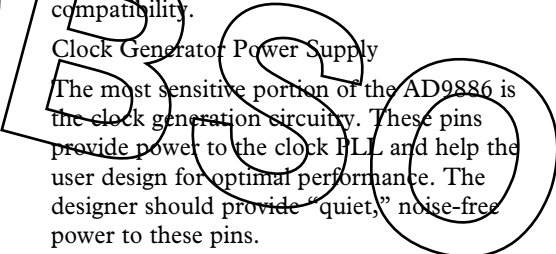
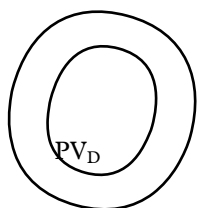

# AD9886

## DESIGN GUIDE

### General Description

The AD9886 is a fully integrated solution for capturing analog RGB signals and digitizing them for display on flat panel monitors or projectors. The circuit is ideal for providing a computer interface for HDTV monitors or as the front end to high-performance video scan converters.

Implemented in a high-performance CMOS process, the interface can capture signals with pixel rates of up to 140 MHz and with an Alternate Pixel Sampling mode, up to 280 MHz.

The AD9886 includes all necessary input buffering, signal dc restoration (clamping), offset and gain (brightness and contrast) adjustment, pixel clock generation, sampling phase control, and output data formatting. All controls are programmable via a 2-wire serial interface. Full integration of these sensitive analog functions makes system design straightforward and less sensitive to the physical and electrical environment.

With a typical power dissipation of less than 750 mW and an operating temperature range of 0°C to 70°C, the device requires no special environmental considerations.

### Input Signal Handling

The AD9886 has three high-impedance analog input pins for the Red, Green, and Blue channels. They will accommodate signals ranging from 0.5 V to 1.0 V p-p.

Signals are typically brought onto the interface board via a DVI-I connector, a 15-pin D connector, or via BNC connectors. The AD9886 should be located as close as practical to the input connector. Signals should be routed via matched-impedance traces (normally 75 Ω) to the IC input pins.

At that point the signal should be resistively terminated (75 Ω to the signal ground return) and capacitively coupled to the AD9886 inputs through 47 nF capacitors. These capacitors form part of the dc restoration circuit.

In an ideal world of perfectly matched impedances, the best performance can be obtained with the widest possible signal bandwidth. The ultrawide bandwidth inputs of the AD9886 (330 MHz) can track the input signal continuously as it moves from one pixel level to the next, and digitize the pixel during a long, flat pixel time. In many systems, however, there are mismatches, reflections, and noise, which can result in excessive ringing and distortion of the input waveform. This makes it more difficult to establish a sampling phase that provides good image quality. It has been shown that a small inductor in series with the input is effective in rolling off the input bandwidth slightly, and providing a high quality signal over a wider range of conditions. Using a Fair-Rite #2508051217Z0 High-Speed Signal Chip Bead inductor in the circuit of Figure 1 gives good results in most applications.

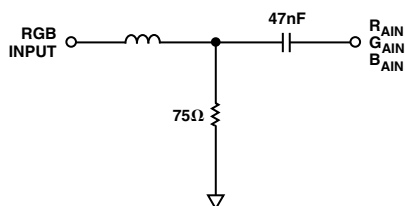

Figure 1. Analog Input Interface Circuit

### HSYNC, VSYNC Inputs

The AD9886 takes a horizontal sync signal, which is used to generate the pixel clock and clamp timing. It is possible to operate the AD9886 without applying HSYNC (using an external clock, external clamp, and single port output mode) but a number of features of the chip will be unavailable, so it is recommended that HSYNC be provided. This can be either a sync signal directly from the graphics source, or a preprocessed TTL or CMOS level signal.

The HSYNC input includes a Schmitt trigger buffer for immunity to noise and signals with long rise times. In typical PC-based graphic systems, the sync signals are simply TTL-level drivers feeding unshielded wires in the monitor cable. As such, no termination is required or desired.

### Serial Control Port

The serial control port is designed for 3.3 V logic. If there are 5 V drivers on the bus, these pins should be protected with 150 Ω series resistors placed between the pull-up resistors and the input pins.

### Output Signal Handling

The digital outputs are designed and specified to operate from a 3.3 V power supply ( $V_{DD}$ ). They can also work with a  $V_{DD}$  as low as 2.5 V for compatibility with other 2.5 V logic.

### Clamping

#### RGB Clamping

To properly digitize the incoming signal, the dc offset of the input must be adjusted to fit the range of the on-board A/D converters.

Most graphics systems produce RGB signals with black at ground and white at approximately 0.75 V. However, if sync signals are embedded in the graphics, the sync tip is often at ground and black is at 300 mV. Then white is at approximately 1.0 V. Some common RGB line amplifier boxes use emitter-follower buffers to split signals and increase drive capability. This introduces a 700 mV dc offset to the signal, which must be removed for proper capture by the AD9886.

The key to clamping is to identify a portion (time) of the signal when the graphic system is known to be producing black. An offset is then introduced which results in the A/D converters producing a black output (code 00h) when the known black input is present. The offset then remains in place when other signal levels are processed, and the entire signal is shifted to eliminate offset errors.

In most graphics systems, black is transmitted between active video lines. Going back to CRT displays, when the electron beam has completed writing a horizontal line on the screen (at the right side), the beam is quickly deflected to the left side of the screen (called horizontal retrace) and a black signal is provided to prevent the beam from disturbing the image.

In systems with embedded sync, a blacker-than-black signal (HSYNC) is produced briefly to signal the CRT that it is time to begin a retrace. For obvious reasons, it is important to avoid clamping on the tip of HSYNC. Fortunately, there is virtually always a period following HSYNC called the back porch where a good black reference is provided. This is the time when clamping should be done.

The clamp timing can be established by simply exercising the CLAMP pin at the appropriate time (with EXTCLMP = 1). The polarity of this signal is set by the Clamp Polarity bit.

A simpler method of clamp timing employs the AD9886 internal clamp timing generator. The Clamp Placement register is programmed with the number of pixel times that should pass after the trailing edge of HSYNC before clamping starts. A second register (Clamp Duration) sets the duration of the clamp. These are both 8-bit values, providing considerable flexibility in clamp generation. The clamp timing is referenced to the trailing edge of HSYNC because, although HSYNC duration can vary widely, the back porch (black reference) always follows HSYNC. A good starting point for establishing clamping is to set the clamp placement to 08h (providing eight pixel periods for the graphics signal to stabilize after sync) and set the clamp duration to 14h (giving the clamp 20 pixel periods to reestablish the black reference).

Clamping is accomplished by placing an appropriate charge on the external input coupling capacitor. (The value of this capacitor affects the performance of the clamp. If it is too small, there will be a significant amplitude change during a horizontal line time (between clamping intervals). If the capacitor is too large, it will take excessively long for the clamp to recover from a large change in incoming signal offset. The recommended value (47 nF) results in recovering from a step error of 100 mV to within 1/2 LSB in 10 lines with a clamp duration of 20 pixel periods on a 60 Hz SXGA signal.)

#### YUV Clamping

YUV graphic signals are slightly different from RGB signals in that the dc reference level (black level in RGB signals) can be at the midpoint of the video signal rather than the bottom. For these signals it can be necessary to clamp to the midscale range of the A/D converter range (10h) rather than bottom of the A/D converter range (00h).

Clamping to midscale rather than ground can be accomplished by setting the clamp select bits in the series bus register. Each of the three converters has its own selection bit so that they can be clamped to either midscale or ground independently. These bits are located in Register 0Fh and are Bits 0–2.

The midscale reference voltage that each A/D converter clamps to is provided independently on the  $R_{MIDSCV}$ ,  $G_{MIDSCV}$ , and  $B_{MIDSCV}$  pins. Each converter must have its own midscale reference because both offset adjustment and gain adjustment for each converter will affect the dc level of midscale.

During clamping, each A/D converter is clamped to its respective midscale reference input. These inputs are pins  $R_{CLAMPV}$ ,  $G_{CLAMPV}$ , and  $B_{CLAMPV}$  for the red, green, and blue converters respectively. The typical connections for both RGB and YUV clamping are shown below in Figure 2. Note: if midscale clamping is not required, all of the midscale voltage outputs should still be connected to ground through a 0.1  $\mu$ F capacitor.

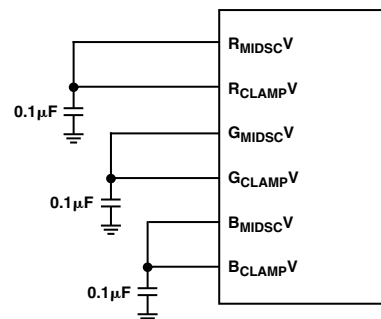

Figure 2. Typical Clamp Configuration for RBG/YUV Applications

#### Gain and Offset Control

The AD9886 can accommodate input signals with inputs ranging from 0.5 V to 1.0 V full scale. The full-scale range is set in three 8-bit registers (Red Gain, Green Gain, and Blue Gain).

Note that increasing the gain setting results in an image with less contrast.

The offset control shifts the entire input range, resulting in a change in image brightness. Three 7-bit registers (Red Offset, Green Offset, Blue Offset) provide independent settings for each channel.

The offset controls provide a  $\pm 63$  LSB adjustment range. This range is connected with the full-scale range, so if the input range is doubled (from 0.5 V to 1.0 V) then the offset/step size is also doubled (from 2 mV per step to 4 mV per step).

Figure 3 illustrates the interaction of gain and offset controls. The magnitude of an LSB in offset adjustment is proportional to the full-scale range, so changing the full-scale range also changes the offset. The change is minimal if the offset setting is near midscale. When changing the offset, the full-scale range is not affected, but the full-scale level is shifted by the same amount as the zero-scale level.

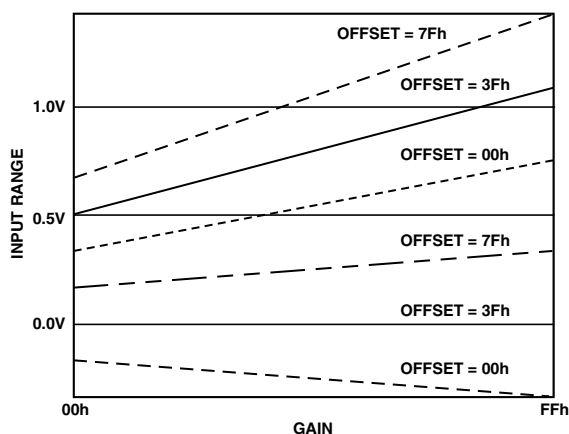

Figure 3. Gain and Offset Control

# AD9886

## Sync-on-Green

The Sync-on-Green input operates in two steps. First, it sets a baseline clamp level from the incoming video signal with a negative peak detector. Second, it sets the sync trigger level to ~150 mV above the negative peak. The Sync-on-Green input must be ac-coupled to the green analog input through its own capacitor as shown in Figure 4. The value of the capacitor must be 1 nF ±20%. If Sync-on-Green is not used, this connection is not required. (Note: The Sync-on-Green signal is always negative polarity.)

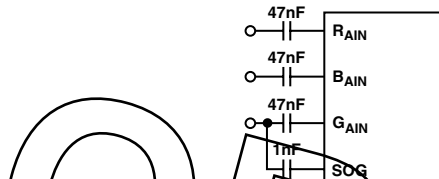

Figure 4. Typical Clamp Configuration for RGB/YUV Applications

## Clock Generation

A Phase Locked Loop (PLL) is employed to generate the pixel clock. In this PLL, the Hsync input provides a reference frequency. A Voltage Controlled Oscillator (VCO) generates a much higher pixel clock frequency. This pixel clock is divided by the PLL divide value (Registers 01H and 02H) and phase compared with the Hsync input. Any error is used to shift the VCO frequency and maintain lock between the two signals.

The stability of this clock is a very important element in providing the clearest and most stable image. During each pixel time, there is a period during which the signal is slewing from the old pixel amplitude and settling at its new value. Then there is a time when the input voltage is stable, before the signal must slew to a new value (see Figure 5). The ratio of the slewing time to the stable time is a function of the bandwidth of the graphics DAC and the bandwidth of the transmission system (cable and termination). It is also a function of the overall pixel rate. Clearly, if the dynamic characteristics of the system remain fixed, the slewing and settling time is likewise fixed. This time must be subtracted from the total pixel period, leaving the stable period. At higher pixel frequencies, the total cycle time is shorter, and the stable pixel time becomes shorter as well.

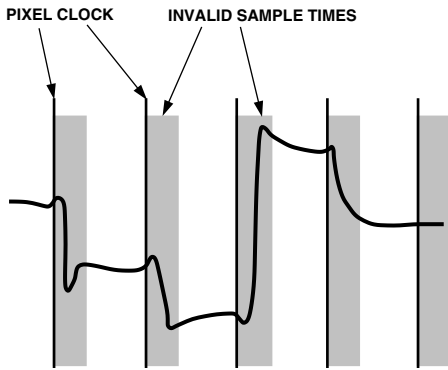

Figure 5. Pixel Sampling Times

Any jitter in the clock reduces the precision with which the sampling time can be determined, and must also be subtracted from the stable pixel time.

Considerable care has been taken in the design of the AD9886's clock generation circuit to minimize jitter. As indicated in Figure 6, the clock jitter of the AD9886 is less than 5% of the total pixel time in all operating modes, making the reduction in the valid sampling time due to jitter negligible.

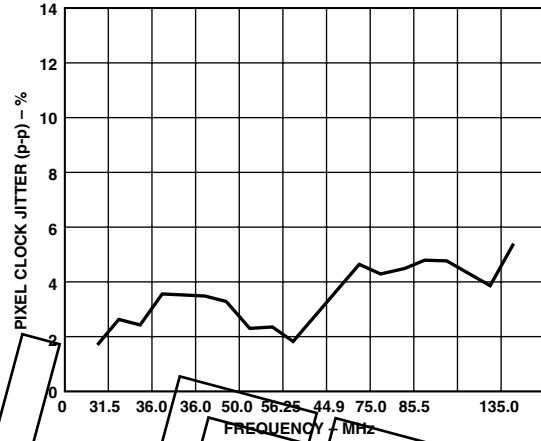

Figure 6. Pixel Clock Jitter vs. Frequency

The PLL characteristics are determined by the loop filter design, by the PLL charge pump current and by the VCO range setting. The loop filter design is illustrated in Figure 7. Recommended settings of VCO range and charge pump current for VESA standard display modes are listed in Table IV.

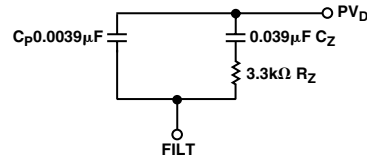

Figure 7. PLL Loop Filter Detail

Four programmable registers are provided to optimize the performance of the PLL. These registers are:

1. The 12-Bit Divisor Register. The input Hsync frequencies range from 15 kHz to 110 kHz. The PLL multiplies the frequency of the Hsync signal, producing pixel clock frequencies in the range of 12 MHz to 140 MHz. The Divisor Register controls the exact multiplication factor. This register may be set to any value between 221 and 4095. (The divide ratio that is actually used is the programmed divide ratio plus one.)
2. The 2-Bit VCO Range Register. To lower the sensitivity of the output frequency to noise on the control signal, the VCO operating frequency range is divided into four overlapping regions. The VCO Range register sets this operating range. Because there are only four possible regions, only the two least-significant bits of the VCO Range register are used. The frequency ranges for the lowest and highest regions are shown in Table II.

Table II. VCO Frequency Ranges

PV1	PV0	Pixel Clock Range (MHz)	K <sub>VCO</sub> Gain (MHz/V)
0	0	12–35	150
0	1	35–70	150
1	0	70–110	150
1	1	110–140	180

3. The 3-Bit Charge Pump Current Register. This register allows the current that drives the low pass loop filter to be varied. The possible current values are listed in Table III.

Table III. Charge Pump Current/Control Bits

Ip2	Ip1	Ip0	Current (µA)
0	0	0	50
0	0	1	100
0	1	0	150
0	1	1	250
1	0	0	350
1	0	1	500
1	1	0	750
1	1	1	1500

4. The 5-Bit Phase Adjust Register. The phase of the generated sampling clock may be shifted to locate an optimum sampling point within a clock cycle. The Phase Adjust register provides 32 phase-shift steps of 11.25° each. The Hsync signal with an identical phase shift is available through the HSOUT pin. Phase adjustment is still available if the pixel clock is being provided externally.

The COAST pin is used to allow the PLL to continue to run at the same frequency, in the absence of the incoming Hsync signal. This may be used during the vertical sync period, or any other time that the Hsync signal is unavailable. The polarity of the COAST signal may be set through the Coast Polarity Register. Also, the polarity of the Hsync signal may be set through the HSYNC Polarity Register. For both HSYNC and COAST, a value of “1” inverts the signal.

Table IV. Recommended VCO Range and Charge Pump Current Settings for Standard Display Formats

Standard	Resolution	Refresh Rate	Horizontal Frequency	Pixel Rate	VCORNGE	CURRENT
VGA	640 × 480	60 Hz	31.5 kHz	25.175 MHz	00	101
		72 Hz	37.7 kHz	31.500 MHz	00	101
		75 Hz	37.5 kHz	31.500 MHz	00	110
		85 Hz	43.3 kHz	36.000 MHz	00	110
SVGA	800 × 600	56 Hz	35.1 kHz	36.000 MHz	00	101
		60 Hz	37.9 kHz	40.000 MHz	01	101
		72 Hz	48.1 kHz	50.000 MHz	01	101
		75 Hz	46.9 kHz	49.500 MHz	01	101
		85 Hz	53.7 kHz	56.250 MHz	01	110
XGA	1024 × 768	60 Hz	48.4 kHz	65.000 MHz	01	110
		70 Hz	56.5 kHz	75.000 MHz	10	101
		75 Hz	60.0 kHz	78.750 MHz	10	101
		80 Hz	64.0 kHz	85.500 MHz	10	101
		85 Hz	68.3 kHz	94.500 MHz	10	101
SXGA	1280 × 1024	60 Hz	64.0 kHz	108.000 MHz	10	110
		75 Hz	80.0 kHz	135.000 MHz	11	110
		85 Hz	91.1 kHz	157.500 MHz*	10	110
UXGA	1600 × 1200	60 Hz	75.0 kHz	162.000 MHz*	10	110
		65 Hz	81.3 kHz	175.500 MHz*	10	110
		70 Hz	87.5 kHz	189.000 MHz*	10	110
		75 Hz	93.8 kHz	202.500 MHz*	10	110
		85 Hz	106.3 kHz	229.500 MHz*	11	110

\*Graphics sampled at one-half the incoming pixel rate using Alternate Pixel Sampling mode.

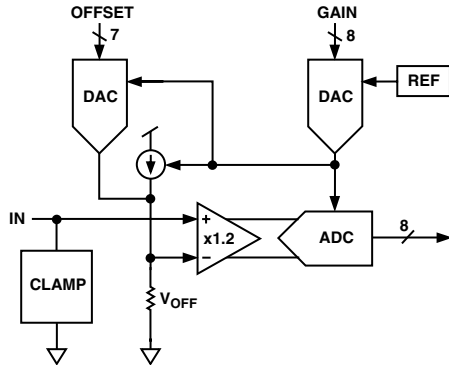

Figure 8. ADC Block Diagram (Single Channel Output)

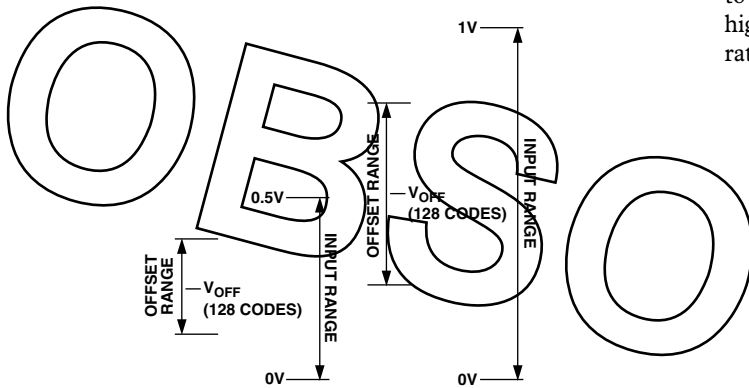

Figure 9. Relationship of Offset Range to Input Range

**SCAN Function**

The SCAN function is intended as a pseudo JTAG function for manufacturing test for the board. The ordinary operation of the AD9886 is disabled during SCAN.

To enable the SCAN function, set register 14h, bit 2 to 1. To SCAN in data to all 48 digital outputs, apply 48 serial bits of data and 48 clocks (typically 5 MHz, max of 20 MHz) to the SCAN<sub>IN</sub> and SCAN<sub>CLK</sub> pins respectively. The data is shifted in on the rising edge of SCAN<sub>CLK</sub>. The first serial bit shifted in will appear at the RED A<7> output after one clock cycle. After 48 clocks, the first bit is shifted all the way to the BLU B<0>. The 48th bit will now be at the RED A<7> output. If SCAN<sub>CLK</sub> continues after 48 cycles, the data will continue to be shifted from RED A<7> to BLU B<0> and will come out of the SCAN<sub>OUT</sub> pin as serial data on the falling edge of SCAN<sub>CLK</sub>. This is illustrated in Figure 10. A setup time (T<sub>su</sub>) of 3 ns should be plenty and no hold time (T<sub>hold</sub>) is required (≥ 0 ns). This is illustrated in Figure 11.

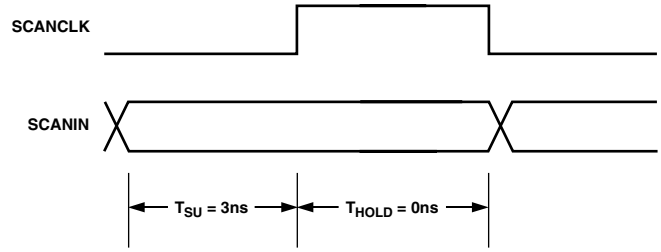

Figure 11. SCAN Setup and Hold

**Alternate Pixel Sampling Mode**

A Logic 1 input on Clock Invert (CKINV, Pin 94) inverts the nominal ADC clock. CKINV can be switched between frames to implement the alternate pixel sampling mode. This allows higher effective image resolution to be achieved at lower pixel rates but with lower frame rates.

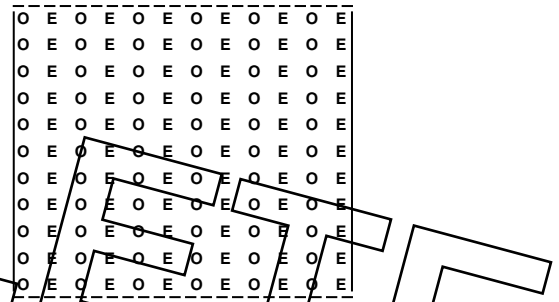

Figure 12. Odd and Even Pixels in a Frame

On one frame, only even pixels are digitized. On the subsequent frame, odd pixels are sampled. By reconstructing the entire frame in the graphics controller, a complete image can be reconstructed. This is very similar to the interlacing process that is employed in broadcast television systems, but the interlacing is vertical instead of horizontal. The frame data is still presented to the display at the full desired refresh rate (usually 60 Hz) so no flicker artifacts added.

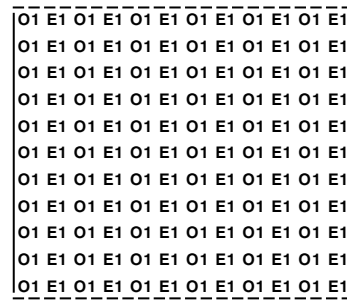

Figure 13. Odd Pixels from Frame 1

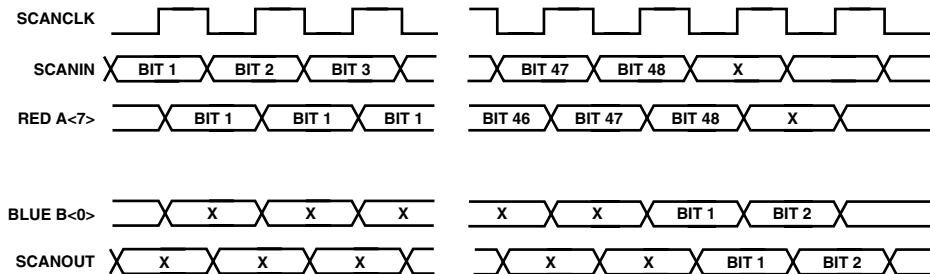

Figure 10. SCAN Timing



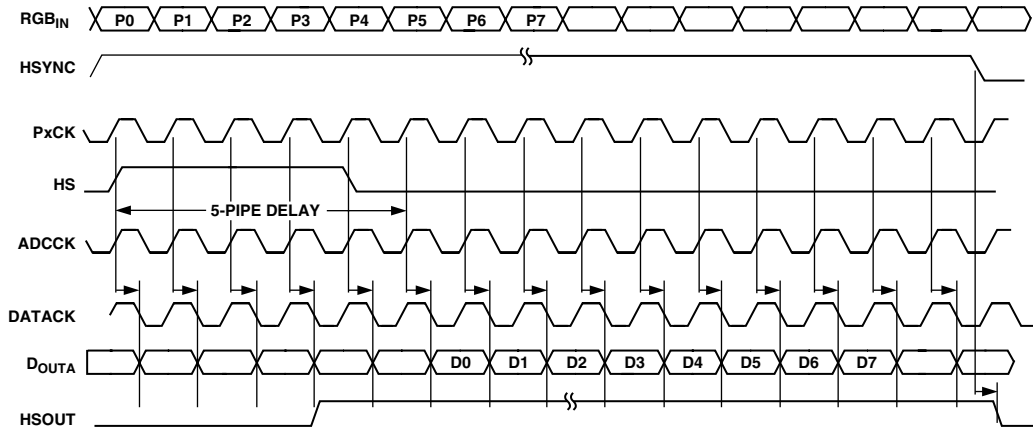

Figure 18. Single-Channel Mode

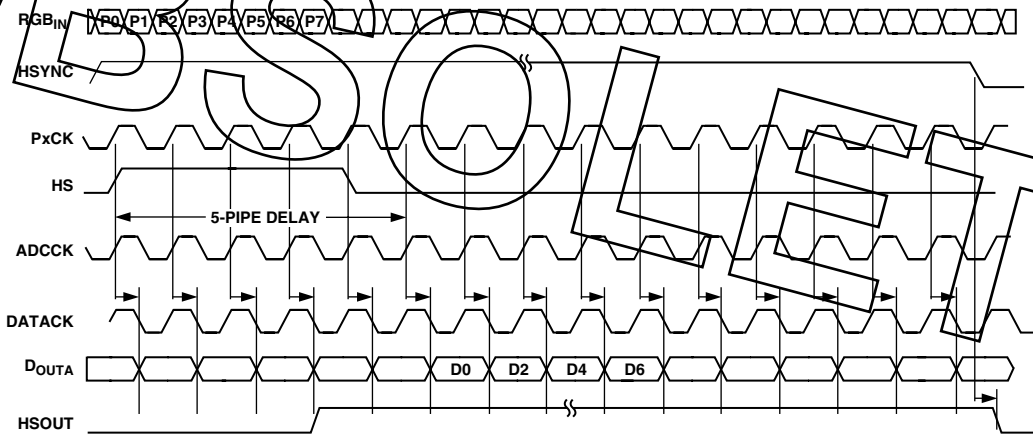

Figure 19. Single-Channel Mode, 2 Pixels/Clock (Even Pixels)

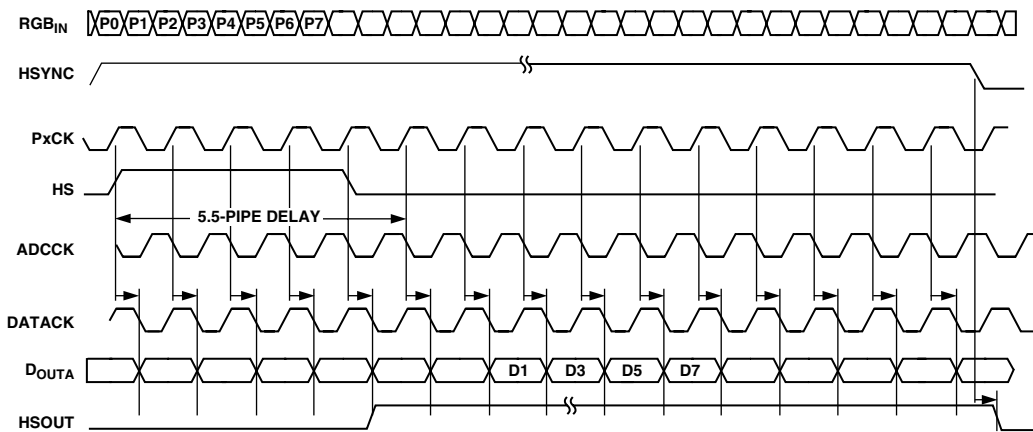

Figure 20. Single-Channel Mode, 2 Pixels/Clock (Odd Pixels)



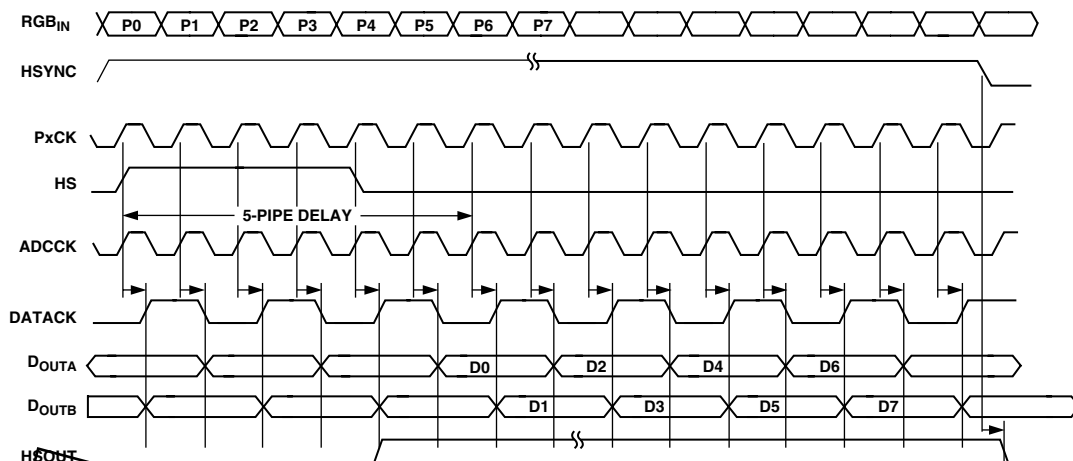

Figure 21. Dual-Channel Mode, Interleaved Outputs

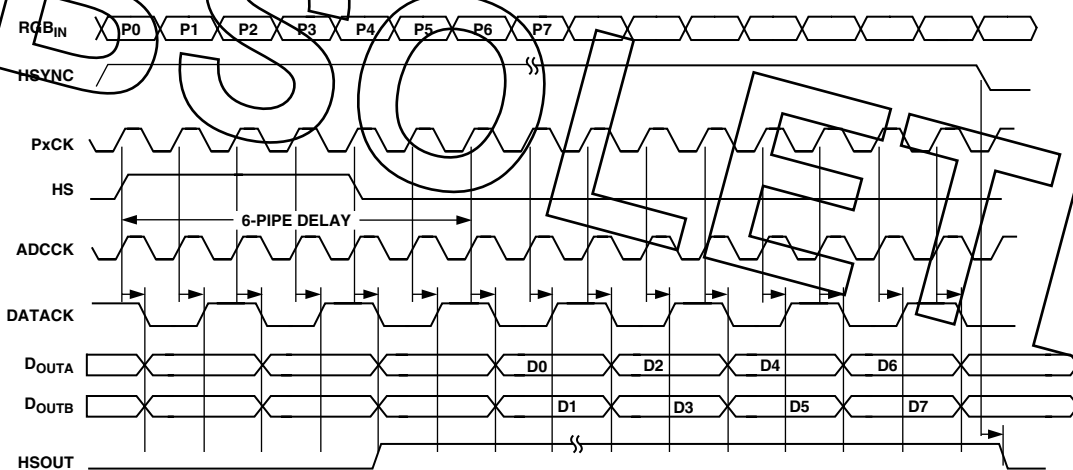

Figure 22. Dual-Channel Mode, Parallel Outputs

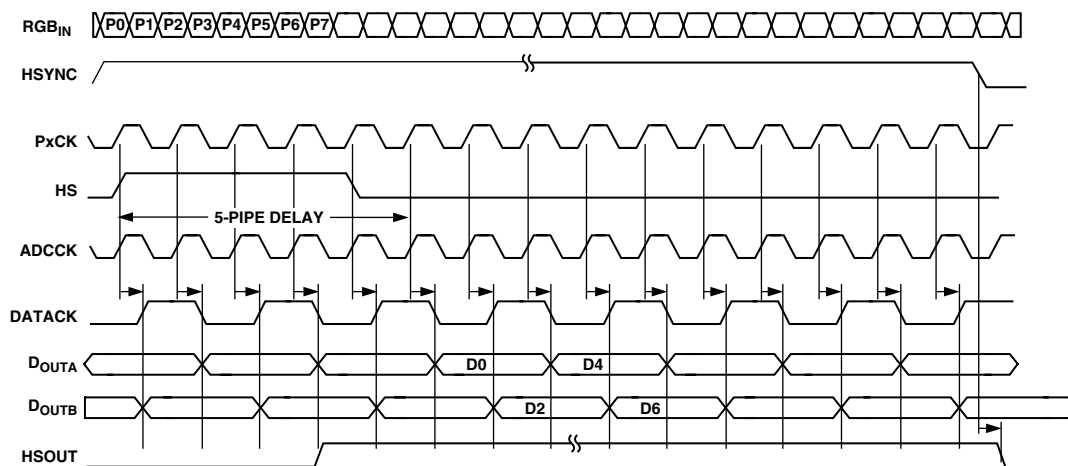

Figure 23. Dual-Channel Mode, Interleaved Outputs, 2 Pixels/Clock (Even Pixels)

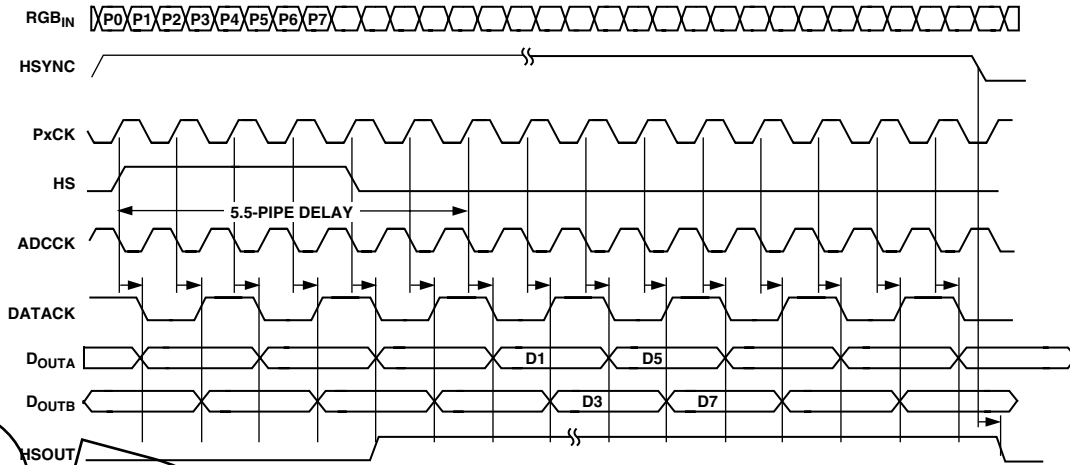

Figure 24. Dual-Channel Mode, Interleaved Outputs, 2 Pixels/Clock (Odd Pixels)

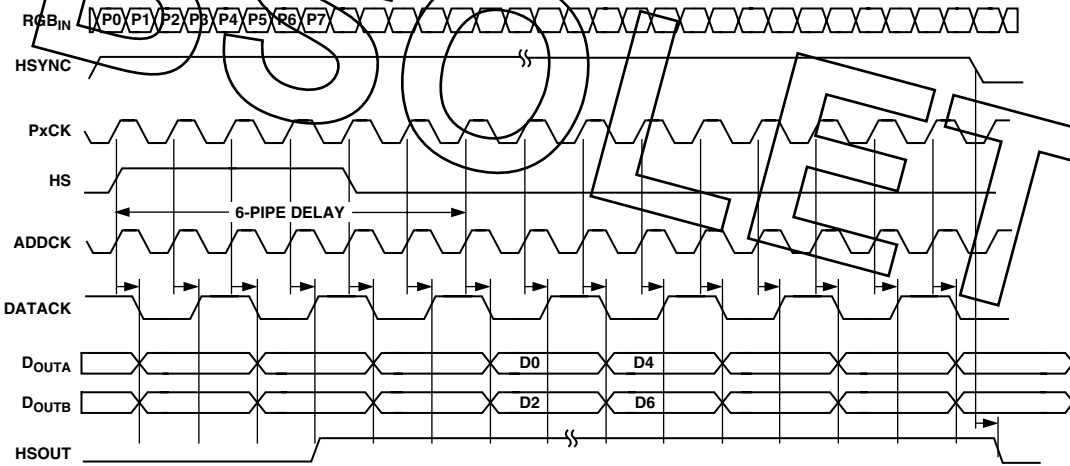

Figure 25. Dual-Channel Mode, Parallel Outputs, 2 Pixels/Clock (Even Pixels)

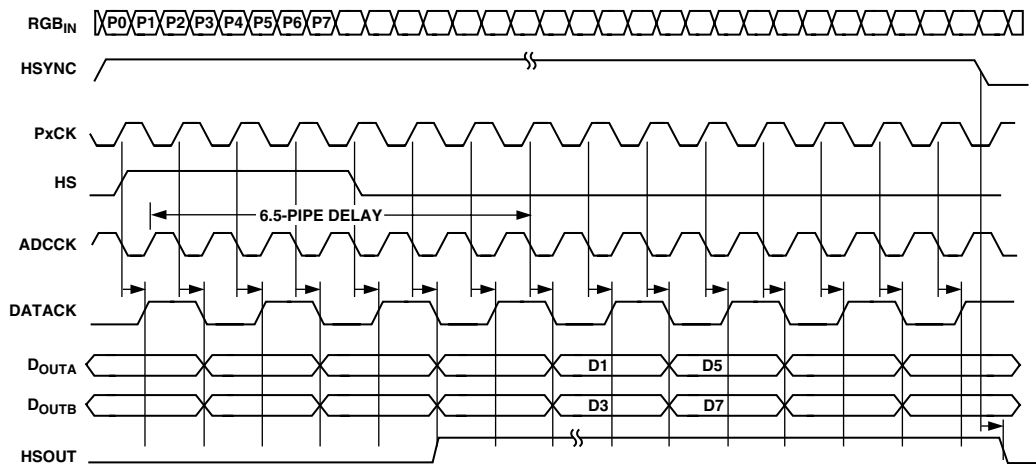

Figure 26. Dual-Channel Mode, Parallel Outputs, 2 Pixels/Clock (Odd Pixels)

## 2-Wire Serial Register Map

The AD9886 is initialized and controlled by a set of registers, which determine the operating modes. An external controller is employed to write and read the Control Registers through the 2-line serial interface port.

**Table V. Control Register Map**

Hex Address	Write and Read or Read Only	Bits	Default Value	Register Name	Function
00H	RO	7:0		Chip Revision	Bits 7 through 4 represent functional revisions to the analog interface. Bits 3 through 0 represent nonfunctional related revisions. Revision 0 = 0000 0000
01H	R/ $\bar{W}$	7:0	01101001	PLL Div MSB	This register is for Bits [11:4] of the PLL divider. Larger values mean the PLL operates at a faster rate. This register should be loaded first whenever a change is needed. (This will give the PLL more time to lock.) See Note 1.
02H	R/ $\bar{W}$	7:4	1101****	PLL Div LSB	Bits [7:4] LSBs of the PLL divider word. See Note 1.
03H	R/ $\bar{W}$	7:2	1***** *01***** ***001**	VCO/CPMP	Bit 7—Must be set to 1 for proper device operation. Bits [6:5] VCO Range. Selects VCO frequency range. (See PLL description.) Bits [4:2] Charge Pump Current. Varies the current that drives the low-pass filter. (See PLL description.)
04H	R/ $\bar{W}$	7:3	01000***	Phase Adjust	ADC Clock phase adjustment. Larger values mean more delay. (1LSB = T/32.)
05H	R/ $\bar{W}$	7:0	10000000	Clamp Placement	Places the Clamp signal an integer number of clock periods after the trailing edge of the Hsync signal.
06H	R/ $\bar{W}$	7:0	10000000	Clamp Duration	Number of clock periods that the Clamp signal is actively clamping.
07H	R/ $\bar{W}$	7:0	00100000	Hsync Output Pulsewidth	Sets the number of pixel clocks that HSOUT will remain active.
08H	R/ $\bar{W}$	7:0	10000000	Red Gain	Controls ADC input range (Contrast) of each respective channel. Bigger values give less contrast.
09H	R/ $\bar{W}$	7:0	10000000	Green Gain	
0AH	R/ $\bar{W}$	7:0	10000000	Blue Gain	
0BH	R/ $\bar{W}$	7:1	1000000*	Red Offset	Controls dc offset (Brightness) of each respective channel. Bigger values decrease brightness.
0CH	R/ $\bar{W}$	7:1	1000000*	Green Offset	
0DH	R/ $\bar{W}$	7:1	1000000*	Blue Offset	
0EH	R/ $\bar{W}$	7:3	1***** *1***** **0***** ***1**** ****1***	Mode Control 1	Bit 7—Channel Mode. Determines Single Channel or Dual Channel Output Mode. (Logic 0 = Single Channel Mode, Logic 1 = Dual Channel Mode.) Bit 6—Output Mode. Determine Interleaved or Parallel Output Mode. (Logic 0 = Interleaved Mode, Logic 1 = Parallel Mode.) Bit 5—A/B Invert. Determines which port outputs the first data byte after Hsync. (Logic 0 = A Port, Logic 1 = B Port.) Bit 4—Hsync Output polarity. (Logic 0 = Logic High Sync, Logic 1 = Logic Low Sync.) Bit 3—Vsync Output Invert. (Logic 0 = No Invert, Logic 1 = Invert.)

Table V. Control Register Map (Continued)

Hex Address	Write and Read or Read Only	Bits	Default Value	Register Name	Function
0FH	$\overline{W}/R$	7:0	1***** *1***** **0***** ***1**** ****0*** *****0** *****0* *****0	PLL and Clamp Control	<p>Bit 7—HSYNC Polarity. Changes polarity of incoming Hsync signal. (Logic 0 = Active Low, Logic 1 = Active High.)</p> <p>Bit 6—Coast Polarity. Changes polarity of external COAST signal. (Logic = 0 = Active Low, Logic 1 = Active High.)</p> <p>Bit 5—Clamp Function. Chooses between HSYNC for Clamp signal or another external signal to be used for clamping. (Logic 0 = HSYNC, Logic 1 = Clamp.)</p> <p>Bit 4—Clamp Polarity. Valid only with external CLAMP signal. (Logic 0 = Active Low, Logic 1 selects Active High.)</p> <p>Bit 3—EXTCLK. Shuts down PLL and allows external clock to drive the part. (Logic 0 = use internal PLL, Logic 1 = bypassing of the internal PLL.)</p> <p>Bit 2—Red Clamp Select—Logic 0 selects clamp to ground. Logic 1 selects clamp to midscale (voltage at Pin 120).</p> <p>Bit 1—Green Clamp Select—Logic 0 selects clamp to ground. Logic 1 selects clamp to midscale (voltage at Pin 111).</p> <p>Bit 0—Blue Clamp Select—Logic 0 selects clamp to ground. Logic 1 selects clamp to midscale (voltage at Pin 101).</p>
10H	$\overline{W}/R$	5:2	**11**** ****0*** *****1**		<p>Bit 5, 4—Output Drive: Selects between high, medium, and low output drive strength. (Logic 11 or 10 = High, 01 = Medium, and 00 = Low.)</p> <p>Bit 3—P<sub>DO</sub>: High Impedance Outputs. (Logic 0 = Normal, Logic 1 = High Impedance.)</p> <p>Bit 2—Sync Detect (SyncDT) Polarity. This bit sets the polarity for the SyncDT output pin. (Logic 1 = Active High, Logic 0 = Active Low.)</p>
11H	RO	7:1		Sync Detect/ Active Interface	<p>Bit 7—Analog Interface Hsync Detect. It is set to Logic 1 if Hsync is present on the analog interface, else it is set to Logic 0.</p> <p>Bit 6—Analog Interface Sync-on-Green Detect. It is set to Logic 1 if sync is present on the green video input, else it is set to 0.</p> <p>Bit 5—Analog Interface Vsync Detect. It is set to Logic 1 if Vsync is present on the analog interface, else it is set to Logic 0.</p> <p>Bit 4—Digital Interface clock Detect. It is set to Logic 1 if the clock is present on the digital interface, else it is set to Logic 0.</p> <p>Bit 3—AI: Active Interface. This bit indicates which interface is active. (Logic 0 = Digital Interface, Logic 1 = Analog Interface.)</p> <p>Bit 2—AHS: Active Hsync. This bit indicates which analog HSYNC is being used. (Logic 0 = HSYNC Input Pin, Logic 1 = HSYNC from Sync-on-Green.)</p> <p>Bit 1—AVS: Active Vsync. This bit indicates which analog VSYNC is being used. (Logic 0 = VSYNC input pin, Logic 1 = VSYNC from sync separator.)</p>

Table V. Control Register Map (Continued)

Hex Address	Write and Read or Read Only	Bits	Default Value	Register Name	Function
12H	$\overline{W}/R$	7:0	0***** *0***** **0***** ***0***** ****0*** *****0** *****1	Active Interface	<p>Bit 7—AIO: Active Interface Override. If set to Logic 1, the user can select the active interface via Bit 6. If set to Logic 0, the active interface is selected via Bit 3 in Register 11H.</p> <p>Bit 6—AIS: Active Interface Select. Logic 0 selects the analog interface as active. Logic 1 selects the digital interface as active. Note: The indicated interface will be active only if Bit 7 is set to Logic 1 or if both interfaces are active (Bits 6 or 7 and 4 = Logic 1 in Register 11H).</p> <p>Bit 5—Active Hsync Override. If set to Logic 1, the user can select the Hsync to be used via Bit 4. If set to Logic 0, the active interface is selected via Bit 2 in Register 11H.</p> <p>Bit 4—Active Hsync Select. Logic 0 selects Hsync as the active sync. Logic 1 selects Sync-on-Green as the active sync. Note: The indicated Hsync will be used only if Bit 5 is set to Logic 1 or if both syncs are active (Bits 6, 7 = Logic 1 in Register 11H.)</p> <p>Bit 3—Active Vsync Override. If set to Logic 1, the user can select the Vsync to be used via Bit 2. If set to Logic 0, the active interface is selected via Bit 1 in Register 11H.</p> <p>Bit 2—Active Vsync Select. Logic 0 selects Raw Vsync as the output Vsync. Logic 1 selects Sync Separated Vsync as the output Vsync. Note: The indicated Vsync will be used only if Bit 3 is set to Logic 1.</p> <p>Bit 1—Coast Select. Logic 0 selects the coast input pin to be used for the PLL coast. Logic 1 selects Vsync to be used for the PLL coast.</p> <p>Bit 0—PWRDN. Full Chip Power-Down, active low. (Logic 0 = Full Chip Power-Down, Logic 1 = Normal.)</p>
13H	$\overline{W}/R$	7:0	00100000	Sync Separator Threshold	Sync Separator Threshold—Sets how many pixel clocks the sync separator will count to before toggling high or low. This should be set to some number greater than the maximum Hsync or equalization pulsewidth.
14H	$\overline{W}/R$	7:0	***1**** *****0** *****0* *****0	Control Bits	<p>Bit 4—Test Bit. (Must be set to 1 for proper operation of chip.)</p> <p>Bit 2—Scan Enable. (Logic 0 = Not Enabled, Logic 1 = Enabled.)</p> <p>Bit 1—Coast Polarity Override. (Logic 0 = Polarity determined by chip, Logic 1 = Polarity set by Bit 6 in Register 0Fh.)</p> <p>Bit 0—Hsync Polarity Override. (Logic 0 = Polarity determined by chip, Logic 1 = Polarity set by Bit 7 in Register 0Fh.)</p>
15H	$\overline{W}/R$	7:0		Test Register	Reserved for future use.
16H	$\overline{W}/R$	7:0		Test Register	Reserved for future use.
17H	RO	7:0		Test Register	Reserved for future use.
18H	RO	7:0		Test Register	Reserved for future use.

## NOTE

<sup>1</sup>The AD9886 only updates the PLL divide ratio when the LSBs are written to (Register 02h).

## TWO-WIRE SERIAL CONTROL REGISTER DETAIL CHIP IDENTIFICATION

### 00 7-0 Chip Revision

Bits 7 through 4 represent functional revisions to the analog interface. Changes in these bits will generally indicate that software and/or hardware changes will be required for the chip to work properly. Bits 3 through 0 represent nonfunctional related revisions and are reset to 0000 whenever the MSBs are changed. Changes in these bits are considered transparent to the user.

## PLL DIVIDER CONTROL

### 01 7-0 PLL Divide Ratio MSBs

The eight most significant bits of the 12-bit PLL divide ratio PLLDIV. (The operational divide ratio is PLLDIV + 1.)

The PLL derives a master clock from an incoming Hsync signal. The master clock frequency is then divided by an integer value, such that the output is phase-locked to Hsync. This PLLDIV value determines the number of pixel times (pixels plus horizontal blanking overhead) per line. This is typically 20% to 30% more than the number of active pixels in the display.

The 12-bit value of the PLL divider supports divide ratios from 2 to 4095. The higher the value loaded in this register, the higher the resulting clock frequency with respect to a fixed Hsync frequency.

VESA has established some standard timing specifications, which will assist in determining the value for PLLDIV as a function of horizontal and vertical display resolution and frame rate (Table IV).

However, many computer systems do not conform precisely to the recommendations, and these numbers should be used only as a guide. The display system manufacturer should provide automatic or manual means for optimizing PLLDIV. An incorrectly set PLLDIV will usually produce one or more vertical noise bars on the display. The greater the error, the greater the number of bars produced.

The power-up default value of PLLDIV is 1693 (PLLDIVM = 69h, PLLDIVL = Dxh).

The AD9886 updates the full divide ratio only when the LSBs are changed. Writing to this register by itself will not trigger an update.

### 02 7-4 PLL Divide Ratio LSBs

The four least significant bits of the 12-bit PLL divide ratio PLLDIV. The operational divide ratio is PLLDIV + 1.

The power-up default value of PLLDIV is 1693 (PLLDIVM = 69h, PLLDIVL = Dxh).

The AD9886 updates the full divide ratio only when this register is written to.

## CLOCK GENERATOR CONTROL

### 03 7 TEST Set to One

### 03 6-5 VCO Range Select

Two bits that establish the operating range of the clock generator.

VCORNGE must be set to correspond with the desired operating frequency (incoming pixel rate).

The PLL gives the best jitter performance at high frequencies. For this reason, in order to output low pixel rates and still get good jitter performance, the PLL actually operates at a higher frequency but then divides down the clock rate afterwards. Table VI shows the pixel rates for each VCO range setting. The PLL output divisor is automatically selected with the VCO range setting.

**Table VI. VCO Ranges**

VCORNGE	Pixel Rate Range
00	12-35
01	35-70
10	70-110
11	110-140

The power-up default value is = 01.

### 03 4-2 CURRENT Charge Pump Current

Three bits that establish the current driving the loop filter in the clock generator.

**Table VII. Charge Pump Currents**

CURRENT	Current (µA)
000	50
001	100
010	150
011	250
100	350
101	500
110	750
111	1500

CURRENT must be set to correspond with the desired operating frequency (incoming pixel rate).

The power-up default value is CURRENT = 001.

### 04 7-3 Clock Phase Adjust

A five-bit value that adjusts the sampling phase in 32 steps across one pixel time. Each step represents an 11.25° shift in sampling phase.

The power-up default value is 16.

## CLAMP TIMING

### 05 7-0 Clamp Placement

An eight-bit register that sets the position of the internally generated clamp.

When EXTCLMP = 0, a clamp signal is generated internally, at a position established by the clamp placement and for a duration set by the clamp duration. Clamping is started (Clamp Placement) pixel periods after the trailing edge of Hsync. The clamp placement may be programmed to any value between 1 and 255. A value of 0 is not supported.

The clamp should be placed during a time that the input signal presents a stable black-level reference, usually the back porch period between Hsync and the image.

When EXTCLMP = 1, this register is ignored.

**06 7-0 Clamp Duration**

An 8-bit register that sets the duration of the internally generated clamp.

When EXTCLMP = 0, a clamp signal is generated internally, at a position established by the clamp placement and for a duration set by the clamp duration. Clamping is started (clamp placement) pixel periods after the trailing edge of Hsync, and continues for (clamp duration) pixel periods. The clamp duration may be programmed to any value between 1 and 255. A value of 0 is not supported.

For the best results, the clamp duration should be set to include the majority of the black reference signal time that follows the Hsync signal trailing edge. Insufficient clamping time can produce brightness changes at the top of the screen, and a slow recovery from large changes in the Average Picture Level (APL), or brightness.

When EXTCLMP = 1, this register is ignored.

**Hsync Pulsewidth****07 7-0 Hsync Output Pulsewidth**

An 8-bit register that sets the duration of the Hsync output pulse.

The leading edge of the Hsync output is triggered by the internally generated, phase-adjusted PLL feedback clock. The AD9886 then counts a number of pixel clocks equal to the value in this register. This triggers the trailing edge of the Hsync output, which is also phase-adjusted.

**INPUT GAIN****08 7-0 Red Channel Gain Adjust**

An 8-bit word that sets the gain of the RED channel. The AD9886 can accommodate input signals with a full-scale range of between 0.5 V and 1.5 V p-p. Setting REDGAIN to 255 corresponds to an input range of 1.0 V. A REDGAIN of 0 establishes an input range of 0.5 V. Note that INCREASING REDGAIN results in the picture having LESS CONTRAST (the input signal uses fewer of the available converter codes). See Figure 3.

**09 7-0 Green Channel Gain Adjust**

An 8-bit word that sets the gain of the GREEN channel. See REDGAIN (08).

**0A 7-0 Blue Channel Gain Adjust**

An 8-bit word that sets the gain of the BLUE channel. See REDGAIN (08).

**INPUT OFFSET****0B 7-1 Red Channel Offset Adjust**

A 7-bit offset binary word that sets the dc offset of the RED channel. One LSB of offset adjustment equals approximately one LSB change in the ADC offset. Therefore, the absolute magnitude of the offset adjustment scales as the gain of the channel is changed. A nominal setting of 31 results in the channel nominally clamping the back porch (during the clamping interval) to Code 00. An offset setting of 63 results in the channel clamping to Code 31 of the ADC. An offset setting of 0 clamps to code -31 (off the bottom of the range). Increasing the value of Red Offset DECREASES the brightness of the channel.

**0C 7-1 Green Channel Offset Adjust**

A 7-bit offset binary word that sets the dc offset of the GREEN channel. See REDOFST (0B).

**0D 7-1 Blue Channel Offset Adjust**

A 7-bit offset binary word that sets the dc offset of the GREEN channel. See REDOFST (0B).

**MODE CONTROL 1****0E 7 Channel Mode**

A bit that determines whether all pixels are presented to a single port (A), or alternating pixels are demultiplexed to Ports A and B.

**Table VIII. Channel Mode Settings**

DEMUX	Function
0	All Data Goes to Port A
1	Alternate Pixels Go to Port A and Port B

When DEMUX = 0, Port B outputs are in a high-impedance state. The maximum data rate for single port mode is 100 MHz. The timing diagrams show the effects of this option.

The power-up default value is 1.

**0E 6 Output Mode**

A bit that determines whether all pixels are presented to Port A and Port B simultaneously on every second DATAACK rising edge, or alternately on port A and Port B on successive DATAACK rising edges.

**Table IX. Output Mode Settings**

PARALLEL	Function
0	Data Is Interleaved
1	Data Is Simultaneous On Every Other Data Clock

When in single port mode (DEMUX = 0), this bit is ignored. The timing diagrams show the effects of this option.

The power-up default value is PARALLEL = 1.

**0E 5 Output Port Phase**

One bit that determines whether even pixels or odd pixels go to Port A.

**Table X. Output Port Phase Settings**

OUTPHASE	First Pixel After Hsync
0	Port A
1	Port B

In normal operation (OUTPHASE = 0), when operating in dual-port output mode (DEMUX = 1), the first sample after the Hsync leading edge is presented at Port A. Every subsequent ODD sample appears at Port A. All EVEN samples go to Port B.

When OUTPHASE = 1, these ports are reversed and the first sample goes to Port B.

When DEMUX = 0, this bit is ignored as data always comes out of only Port A.

## 0E 4 HSYNC Output Polarity

One bit that determines the polarity of the HSYNC output and the SOG output. Table XI shows the effect of this option. SYNC indicates the logic state of the sync pulse.

**Table XI. HSYNC Output Polarity Settings**

Setting	SYNC
0	Logic 1 (Positive Polarity)
1	Logic 0 (Negative Polarity)

The default setting for this register is 1. (This option works on both the analog and digital interfaces.)

## 0E 3 VSYNC Output Invert

One bit that inverts the polarity of the VSYNC output. Table XII shows the effect of this option.

**Table XII. VSYNC Output Polarity Settings**

Setting	VSYNC Output
0	No Invert
1	Invert

The default setting for this register is 1. (This option works on both the analog and digital interfaces.)

## 0F 7 HSPOL HSYNC Input Polarity

A bit that must be set to indicate the polarity of the HSYNC signal that is applied to the PLL HSYNC input.

**Table XIII. HSYNC Input Polarity Settings**

HSPOL	Function
0	Active LOW
1	Active HIGH

Active LOW is the traditional negative-going Hsync pulse. All timing is based on the leading edge of Hsync, which is the FALLING edge. The rising edge has no effect.

Active HIGH is inverted from the traditional Hsync, with a positive-going pulse. This means that timing will be based on the leading edge of Hsync, which is now the RISING edge.

The device will operate if this bit is set incorrectly, but the internally generated clamp position, as established by CLPOS, will not be placed as expected, which may generate clamping errors.

The power-up default value is HSPOL = 1.

## 0F 6 COAST Input Polarity

A bit to indicate the polarity of the COAST signal that is applied to the PLL COAST input.

**Table XIV. COAST Input Polarity Settings**

CSTPOL	Function
0	Active LOW
1	Active HIGH

Active LOW means that the clock generator will ignore Hsync inputs when COAST is LOW, and continue operating at the same nominal frequency until COAST goes HIGH.

Active HIGH means that the clock generator will ignore Hsync inputs when COAST is HIGH, and continue operating at the same nominal frequency until COAST goes LOW.

This function needs to be used along with the COAST polarity override bit (Register 14, Bit 1).

The power-up default value is CSTPOL = 1.

## 0F 5 Clamp Input Signal Source

A bit that determines the source of clamp timing.

**Table XV. Clamp Input Signal Source Settings**

EXTCLMP	Function
0	Internally-Generated Clamp
1	Externally-Provided Clamp Signal

A 0 enables the clamp timing circuitry controlled by CLPLACE and CLDUR. The clamp position and duration is counted from the leading edge of Hsync.

A 1 enables the external CLAMP input pin. The three channels are clamped when the CLAMP signal is active. The polarity of CLAMP is determined by the CLAMPOL bit.

The power-up default value is EXTCLMP = 0.

## 0F 4 CLAMP Input Signal Polarity

A bit that determines the polarity of the externally provided CLAMP signal.

**Table XVI. CLAMP Input Signal Polarity Settings**

EXTCLMP	Function
0	Active LOW
1	Active HIGH

A Logic 0 means that the circuit will clamp when CLAMP is HIGH, and it will pass the signal to the ADC when CLAMP is LOW.

A Logic 1 means that the circuit will clamp when CLAMP is LOW, and it will pass the signal to the ADC when CLAMP is HIGH.

The power-up default value is CLAMPOL = 1.

## 0F 3 External Clock Select

A bit that determines the source of the pixel clock.

**Table XVII. External Clock Select Settings**

EXTCLK	Function
0	Internally Generated Clock
1	Externally Provided Clock Signal

A Logic 0 enables the internal PLL that generates the pixel clock from an externally provided Hsync.

A Logic 1 enables the external CKEXT input pin. In this mode, the PLL Divide Ratio (PLLDIV) is ignored. The clock phase adjust (PHASE) is still functional.

The power-up default value is EXTCLK = 0.



**0F 2 Red Clamp Select**

A bit that determines whether the red channel is clamped to ground or to midscale. For RGB video, all three channels are referenced to ground. For YcbCr (or YUV), the Y channel is referenced to ground, but the CbCr channels are referenced to midscale. Clamping to midscale actually clamps to Pin 118, R<sub>CLAMPV</sub>.

**Table XVIII. Red Clamp Select Settings**

Clamp	Function
0	Clamp to Ground
1	Clamp to Midscale (Pin 118)

The default setting for this register is 0.

**0F 1 Green Clamp Select**

A bit that determines whether the green channel is clamped to ground or to midscale.

**Table XIX. Green Clamp Select Settings**

Clamp	Function
0	Clamp to Ground
1	Clamp to Midscale (Pin 109)

The default setting for this register is 0.

**0F 0 Blue Clamp Select**

A bit that determines whether the blue channel is clamped to ground or to midscale.

**Table XX. Blue Clamp Select Settings**

Clamp	Function
0	Clamp to Ground
1	Clamp to Midscale (Pin 99)

The default setting for this register is 0.

**MODE CONTROL 2**

**10 7 Clk Inv Data Output Clock Invert**

A control bit for the inversion of the output data clocks, (Pins 134, 135). This function works only for the digital interface. When not inverted, data is output on the rising edge of the data clock. See timing diagrams to see how this affects timing.

**Table XXI. Clock Output Invert Settings**

Clk Inv	Function
0	Not Inverted
1	Inverted

The default for this register is 0, not inverted.

**10 6 Pix Select**

This bit selects either 1 or 2 pixels per clock mode for the digital interface. It determines whether the data comes out of a single port (even port only), at the full data rate or out of two ports (both even and odd ports) at one-half the full data rate per port. A Logic 0 selects 1 pixel per clock

(even port only). A Logic 1 selects 2 pixels per clock (both ports). See the Digital Interface Timing Diagrams, Figures 29 to 32, for a visual representation of this function. Note: This function operates exactly like the DEMUX function on the analog interface.

**Table XXII. Pix Select Settings**

Pix Select	Function
0	1 Pixel per Clock
1	2 Pixels per Clock

The default for this register is 0, 1 pixel per clock.

**10 5, 4 Output Drive**

These two bits select the drive strength for the high-speed digital outputs (all data output and clock output pins). Higher drive strength results in faster rise/fall times and in general makes it easier to capture data. Lower drive strength results in slower rise/fall times and helps to reduce EMI and digitally generated power supply noise. The exact timing specifications for each of these modes are specified in the Table IV.

**Table XXIII. Output/Drive Strength Settings**

Bit 5	Bit 4	Result
1	1	High Drive Strength
1	0	Medium Drive Strength
0	X	Low Drive Strength

The default for this register is 11, high drive strength. (This option works on both the analog and digital interfaces.)

**10 3 P<sub>DO</sub>—Power-Down Outputs**

A bit that can put the outputs in a high impedance mode. This applies only to the 48 data output pins and the two data clock outputs pins.

**Table XXIV. Power-Down Outputs Settings**

CKINV	Function
0	Normal Operation
1	Three-State

The default for this register is 0. (This option works on both the analog and digital interfaces.)

**10 2 Sync Detect Polarity**

This pin controls the polarity of the Sync Detect output pin (Pin 136).

**Table XXV. Sync Detect Polarity Settings**

Polarity	Function
0	Activity = Logic 1 Output
1	Activity = Logic 0 Output

The default for this register is 0. (This option works on both the analog and digital interfaces.)

## SYNC DETECTION AND CONTROL

### 11 7 Analog Interface HSYNC Detect

This bit is used to indicate when activity is detected on the HSYNC input pin (Pin 82). If HSYNC is held high or low, activity will not be detected.

**Table XXVI. HSYNC Detection Results**

Detect	Function
0	No Activity Detected
1	Activity Detected

Figure 38 shows where this function is implemented.

### 11 6 Analog Interface Sync-on-Green Detect

This bit is used to indicate when sync activity is detected on the Sync-on-Green input pin (Pin 108).

**Table XXVII. Sync-on-Green Detection Results**

Detect	Function
0	No Activity Detected
1	Activity Detected

Figure 38 shows where this function is implemented.

Warning: If no sync is present on the green video input, normal video may still trigger activity.

### 11 5 Analog Interface VSYNC Detect

This bit is used to indicate when activity is detected on the VSYNC input pin (Pin 81). If VSYNC is held high or low, activity will not be detected.

**Table XXVIII. VSYNC Detection Results**

Detect	Function
0	No Activity Detected
1	Activity Detected

Figure 38 shows where this function is implemented.

### 11 4 Digital Interface Clock Detect

This bit is used to indicate when activity is detected on the digital interface clock input.

**Table XXIX. Digital Interface Clock Detection Results**

Detect	Function
0	No Activity Detected
1	Activity Detected

The sync processing block diagram shows where this function is implemented.

### 11 3 Active Interface

This bit is used to indicate which interface should be active, analog or digital. It checks for activity on the analog interface and for activity on the digital interface, then determines which should be active according to Table XXX. Specifically, analog interface detection is determined by OR-ing Bits 7, 6, and 5 in this register. Digital interface detection is determined by Bit 4 in this

register. If both interfaces are detected, the user can determine which has priority via Bit 6 in register 12H. The user can override this function via Bit 7 in Register 12H. If the override bit is set to Logic 1, then this bit will be forced to whatever the state of Bit 6 in Register 12H is set to.

**Table XXX. Active Interface Results**

Bits 7, 6, or 5 (Analog Detection)	Bit 4 (Digital Detection)	Override	AI
0	0	0	Soft Power-Down (Seek Mode)
0	1	0	1
1	0	0	0
1	1	0	Bit 6 in 12H
X	X	1	Bit 6 in 12H

AI = 0 means Analog Interface.  
AI = 1 means Digital Interface.  
The override bit is in Register 12H, Bit 7.

### 2 AHS—Active HSYNC

This bit is used to determine which HSYNC should be used for the analog interface, the HSYNC input or Sync-on-Green. It uses Bits 7 and 6 in this register for inputs in determining which should be active. Similar to the previous bit, if both HSYNC and SOG are detected the user can determine which has priority via Bit 4 in Register 12H. The user can override this function via Bit 5 in Register 12H. If the override bit is set to Logic 1, this bit will be forced to whatever the state of Bit 4 in Register 12H is set to.

**Table XXXI. Active HSYNC Results**

Bit 7 (HSYNC Detect)	Bit 6 (SOG Detect)	Override	AHS
0	0	0	Bit 4 in 12H
0	1	0	1
1	0	0	0
1	1	0	Bit 4 in 12H
X	X	1	Bit 4 in 12H

AHS = 0 means use the HSYNC pin input for HSYNC.  
AHS = 1 means use the SOG pin input for HSYNC.  
The override bit is in Register 12H, Bit 5.

### 11 1 AVS—Active VSYNC

This bit is used to determine which VSYNC should be used for the analog interface; the VSYNC input or output from the sync separator. It uses Bit 5 in this register as the input for determining which should be active. Similar to the previous bit, if both HSYNC and SOG are detected the user can determine which has priority via Bit 4 in register 12H. The user can override this function via Bit 3 in Register 12H. If the override bit is set to Logic 1, this bit will be forced to whatever the state of Bit 2 in Register 12H is set to.

**Table XXXII. Active VSYNC Results**

Bit 5 (VSYNC Detect)	Override	AVS
0	0	0
1	0	1
X	1	Bit 2 in 12H

AVS = 0 means Sync separator.  
 AVS = 1 means VSYNC input.  
 The override bit is in Register 12H, Bit 3.

**12 7 AIO—Active Interface Override**

This bit is used to override the automatic interface selection (Bit 3 in Register 11H). To override, set this bit to Logic 1. When overriding, the active interface is set via Bit 6 in this register.

**Table XXXIII. Active Interface Override Settings**

AIO	Result
0	Autodetermines the Active Interface
1	Override, Bit 6 Determines the Active Interface

The default for this register is 0.

**12 6 AIS—Active Interface Select**

This bit is used under two conditions. It is used to select the active interface when the override bit is set (Bit 7). Alternately, it is used to determine the active interface when not overriding but both interfaces are detected.

**Table XXXIV. Active Interface Select Settings**

AIS	Result
0	Analog Interface
1	Digital Interface

The default for this register is 0.

**12 5 Active Hsync Override**

This bit is used to override the automatic Hsync selection (Bit 2 in Register 11H). To override, set this bit to Logic 1. When overriding, the active Hsync is set via Bit 4 in this register.

**Table XXXV. Active Hsync Override Settings**

Override	Result
0	Autodetermines the Active Interface
1	Override, Bit 4 Determines the Active Interface

The default for this register is 0.

**12 4 Active Hsync Select**

This bit is used under two conditions. It is used to select the active Hsync when the override bit is set (Bit 5). Alternately, it is used to determine the active Hsync when not overriding but both Hsyncs are detected.

**Table XXXVI. Active HSYNC Select Settings**

Select	Result
0	HSYNC Input
1	Sync-on-Green Input

The default for this register is 0.

**12 3 Active VSYNC Override**

This bit is used to override the automatic VSYNC selection (Bit 1 in register 11H). To override, set this bit to Logic 1. When overriding, the active interface is set via Bit 2 in this register.

**Table XXXVII. Active VSYNC Override Settings**

Override	Result
0	Autodetermines the Active VSYNC
1	Override, Bit 2 Determines the Active VSYNC

The default for this register is 0.

**12 2 Active VSYNC Select**

This bit is used to select the active VSYNC when the override bit is set (Bit 3).

**Table XXXVIII. Active VSYNC Select Settings**

Select	Result
0	VSYNC Input
1	Sync Separator Output

The default for this register is 0.

**12 1 COAST Select**

This bit is used to select the active COAST source. The choices are the COAST input pin or VSYNC. If VSYNC is selected the additional decision of using the VSYNC input pin or the output from the sync separator needs to be made (Bits 3, 2).

**Table XXXIX. COAST Select Settings**

Select	Result
0	COAST Input Pin
1	VSYNC (See Above Text)

The default for this register is 0.

**12 0 PWRDN**

This bit is used to put the chip in full power-down. This powers down both interfaces. See the section on Power Management for details of which blocks are actually powered down. Note, the chip will be unable to detect incoming activity while fully powered-down.

**Table XL. Power-Down Settings**

Select	Result
0	Power-Down
1	Normal Operation

The default for this register is 1.

# AD9886

## DIGITAL CONTROL

### 13 7:0 Sync Separator Threshold

This register is used to set the responsiveness of the sync separator. It sets how many pixel clock pulses the sync separator must count to before toggling high or low. It works like a low-pass filter to ignore Hsync pulses in order to extract the Vsync signal. This register should be set to some number greater than the maximum Hsync pulsewidth.

The default for this register is 32.

## CONTROL BITS

### 14 2 Scan Enable

This register is used to enable the scan function. When enabled, data can be loaded into the AD9886 outputs serially with the scan function. The scan function utilizes three pins (SCAN<sub>IN</sub>, SCAN<sub>OUT</sub>, and SCAN<sub>CLK</sub>). These pins are described in Table I.

Table XLII. Scan Enable Settings

Scan Enable	Result
0	Scan Function Disabled
1	Scan Function Enabled

The default for scan enable is 0 (disabled).

### 14 1 Coast Input Polarity Override

This register is used to override the internal circuitry that determines the polarity of the coast signal going into the PLL.

Table XLIII. Coast Input Polarity Override Settings

Override Bit	Result
0	Coast Polarity Determined by Chip
1	Coast Polarity Determined by User

The default for coast polarity override is 0 (polarity determined by chip).

### 14 0 HSYNC Input Polarity Override

This register is used to override the internal circuitry that determines the polarity of the Hsync signal going into the PLL.

Table XLIV. HSYNC Input Polarity Override Settings

Override Bit	Result
0	Hsync Polarity Determined by Chip
1	Hsync Polarity Determined by User

The default for Hsync polarity override is 0 (polarity determined by chip).

## 2-WIRE SERIAL CONTROL PORT

A 2-wire serial interface control interface is provided. Up to four AD9886 devices may be connected to the 2-wire serial interface, with each device having a unique address.

The 2-wire serial interface comprises a clock (SCL) and a bidirectional data (SDA) pin. The Analog Flat Panel Interface acts as a slave for receiving and transmitting data over the serial

interface. When the serial interface is not active, the logic levels on SCL and SDA are pulled HIGH by external pull-up resistors.

Data received or transmitted on the SDA line must be stable for the duration of the positive-going SCL pulse. Data on SDA must change only when SCL is LOW. If SDA changes state while SCL is HIGH, the serial interface interprets that action as a start or stop sequence.

There are six components to serial bus operation:

- Start Signal
- Slave Address Byte
- Base Register Address Byte
- Data Byte to Read or Write
- Stop Signal

When the serial interface is inactive (SCL and SDA are HIGH) communications are initiated by sending a start signal. The start signal is a HIGH-to-LOW transition on SDA while SCL is HIGH. This signal alerts all slaved devices that a data transfer sequence is coming.

The first eight bits of data transferred after a start signal comprising a 7-bit slave address (the first seven bits) and a single R/W bit (the eighth bit). The R/W bit indicates the direction of data transfer, read from (1) or write to (0) the slave device. If the transmitted slave address matches the address of the device (set by the state of the SA<sub>1-0</sub> input pins in Table XLIV, the AD9886 acknowledges by bringing SDA LOW on the 9th SCL pulse. If the addresses do not match, the AD9886 does not acknowledge.

Table XLV. Serial Port Addresses

Bit 7 A <sub>6</sub> (MSB)	Bit 6 A <sub>5</sub>	Bit 5 A <sub>4</sub>	Bit 4 A <sub>3</sub>	Bit 3 A <sub>2</sub>	Bit 2 A <sub>1</sub>	Bit 1 A <sub>0</sub>
1	0	0	1	1	0	0
1	0	0	1	1	0	1
1	0	0	1	1	1	0
1	0	0	1	1	1	1

## Data Transfer via Serial Interface

For each byte of data read or written, the MSB is the first bit of the sequence.

If the AD9886 does not acknowledge the master device during a write sequence, the SDA remains HIGH so the master can generate a stop signal. If the master device does not acknowledge the AD9886 during a read sequence, the AD9886 interprets this as "end of data." The SDA remains HIGH so the master can generate a stop signal.

Writing data to specific control registers of the AD9886 requires that the 8-bit address of the control register of interest be written after the slave address has been established. This control register address is the base address for subsequent write operations. The base address autoincrements by one for each byte of data written after the data byte intended for the base address. If more bytes are transferred than there are available addresses, the address will not increment and remain at its maximum value of 1Dh. Any base address higher than 1Dh will not produce an acknowledge signal.

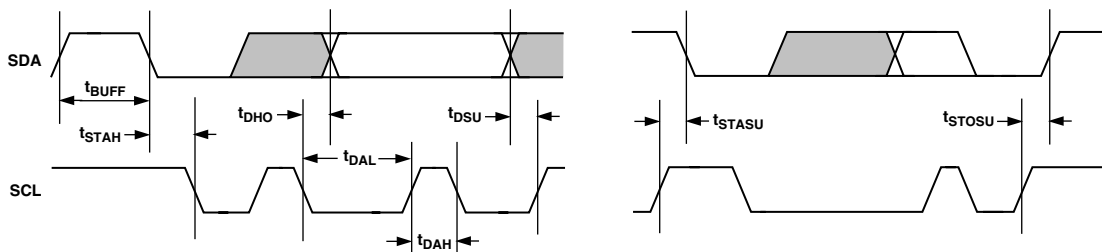

Figure 27. Serial Port Read/Write Timing

Data is read from the control registers of the AD9886 in a similar manner. Reading requires two data transfer operations:

The base address must be written with the R/W bit of the slave address byte LOW to set up a sequential read operation.

Reading (the R/W bit of the slave address byte HIGH) begins at the previously established base address. The address of the read register autoincrements after each byte is transferred.

To terminate a read/write sequence to the AD9886, a stop signal must be sent. A stop signal comprises a LOW-to-HIGH transition of SDA while SCL is HIGH.

A repeated start signal occurs when the master device driving the serial interface generates a start signal without first generating a stop signal to terminate the current communication. This is used to change the mode of communication (read, write) between the slave and master without releasing the serial interface lines.

**Serial Interface Read/Write Examples**

Write to one control register

- Start signal
- Slave Address byte (R/W bit = LOW)
- Base Address byte
- Data byte to base address
- Stop signal

Write to four consecutive control registers

- Start signal
- Slave Address byte (R/W bit = LOW)
- Base Address byte
- Data byte to base address
- Data byte to (base address + 1)
- Data byte to (base address + 2)
- Data byte to (base address + 3)
- Stop signal

Read from one control register

- Start signal
- Slave Address byte (R/W bit = LOW)
- Base Address byte
- Start signal
- Slave Address byte (R/W bit = HIGH)
- Data byte from base address
- Stop signal

Read from four consecutive control registers

- Start signal
- Slave Address byte (R/W bit = LOW)
- Base Address byte
- Start signal
- Slave Address byte (R/W bit = HIGH)
- Data byte from base address
- Data byte from (base address + 1)
- Data byte from (base address + 2)
- Data byte from (base address + 3)
- Stop signal



Figure 28. Serial Interface—Typical Byte Transfer

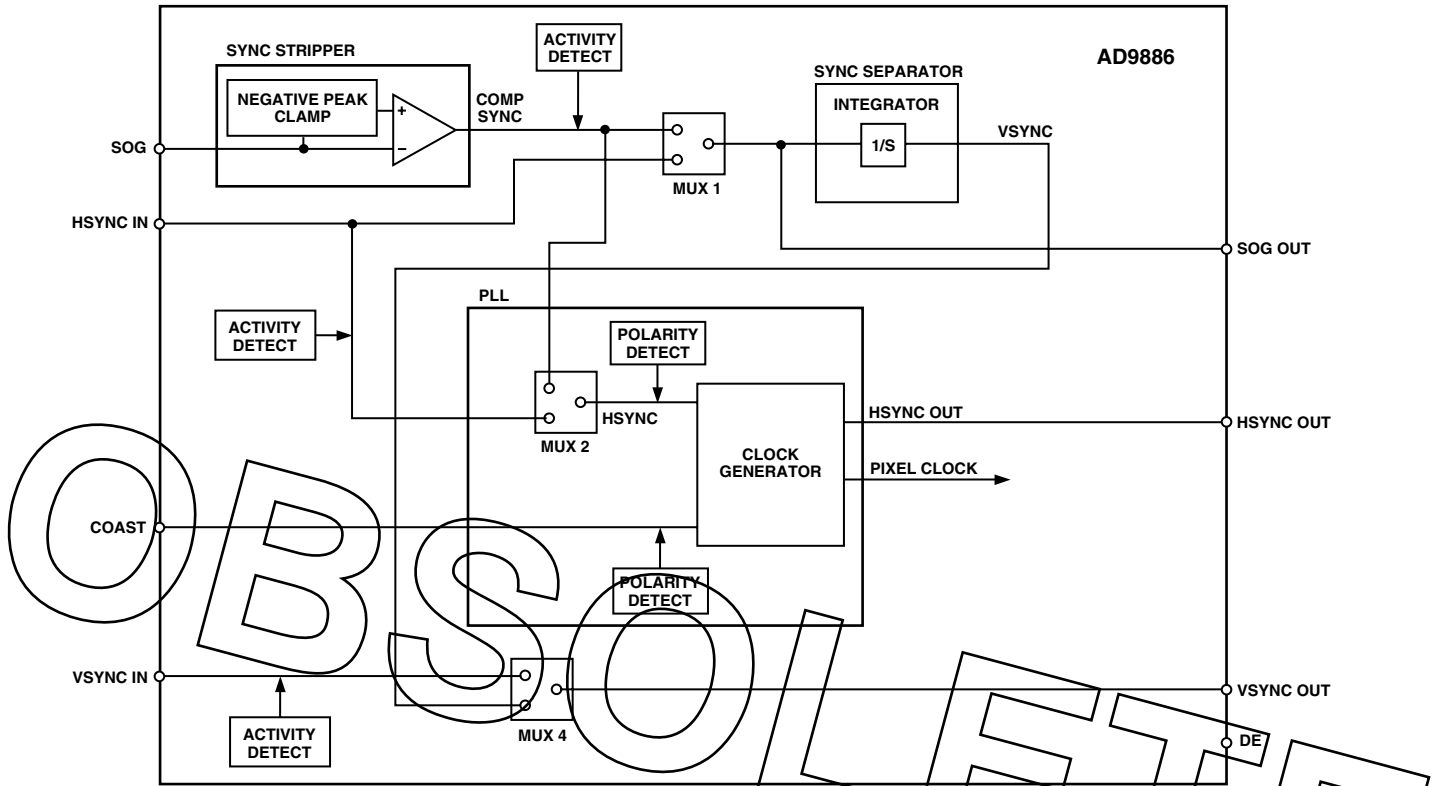

Figure 29. Sync Processing Block Diagram

Table XLV. Control of the Sync Block Muxes via the Serial Register

Mux Nos.	Serial Bus Control Bit	Control Bit State	Result
1 and 2	12H: Bit 4	0	Pass Hsync
		1	Pass Sync-on-Green
4	12H: Bit 2	0	Pass Vsync
		1	Pass Sync Separator Signal

**Sync Slicer**

The purpose of the sync slicer is to extract the sync signal from the green graphics channel. A sync signal is not present on all graphics systems, only those with “sync-on-green.” The sync signal is extracted from the green channel in a two step process. First, the SOG input is clamped to its negative peak (typically 0.3 V below the black level). Next, the signal goes to a comparator with a trigger level that is 0.15 V above the clamped level. The “sliced” sync is typically a composite sync signal containing both Hsync and Vsync.

**Sync Separator**

A sync separator extracts the Vsync signal from a composite sync signal. It does this through a low-pass filter-like or integrator-like operation. It works on the idea that the Vsync signal stays active for a much longer time than the Hsync signal, so it rejects any signal shorter than a threshold value, which is somewhere between an Hsync pulsewidth and a Vsync pulsewidth.

The sync separator on the AD9886 is simply an 8-bit digital counter with a 5 MHz clock. It works independently of the polarity of the composite sync signal. (Polarities are determined elsewhere on the chip.) The basic idea is that the counter counts up when Hsync pulses are present. But since Hsync pulses are relatively short in width, the counter only reaches a value of N before the pulse ends. It then starts counting down eventually reaching 0 before the next Hsync pulse arrives. The specific value of N will vary for different video modes, but will always be less than 255. For example with a 1 μs width Hsync, the counter will only reach 5 (1μs/200 ns = 5). Now, when Vsync is present on the composite sync the counter will also count up. However, since the Vsync signal is much longer, it will count to a higher number M. For most video modes, M will be at least 255. So, Vsync can be detected on the composite sync signal by detecting when the counter counts to higher than N. The specific count that triggers detection (T) can be programmed through the serial register (0fh).

Once Vsync has been detected, there is a similar process to detect when it goes inactive. At detection, the counter first resets to 0, then starts counting up when Vsync goes away. Similar to the previous case, it will detect the absence of Vsync when the counter reaches the threshold count (T). In this way, it will reject noise and/or serration pulses. Once Vsync is detected to be absent, the counter resets to 0 and begins the cycle again.

## PCB LAYOUT RECOMMENDATIONS

The AD9886 is a high-precision, high-speed analog device. As such, to get the maximum performance out of the part it is important to have a well laid-out board. The following is a guide for designing a board using the AD9886.

### Analog Interface Inputs

Using the following layout techniques on the graphics inputs is extremely important:

Minimize the trace length running into the graphics inputs. This is accomplished by placing the AD9886 as close as possible to the graphics VGA connector. Long input trace lengths are undesirable because they will pick up more noise from the board and other external sources.

Place the 75  $\Omega$  termination resistors as close to the AD9886 chip as possible. Any additional trace length between the termination resistors and the input of the AD9886 increases the magnitude of reflections, which will corrupt the graphics signal.

Use 75  $\Omega$  matched impedance traces. Trace impedances other than 75  $\Omega$  will also increase the chance of reflections.

The AD9886 has very high input bandwidth (330 MHz). While this is desirable for acquiring a high resolution PC graphics signal with fast edges, it means that it will also capture any high frequency noise present. Therefore, it is important to reduce the amount of noise that gets coupled to the inputs. Avoid running any digital traces near the analog inputs.

Due to the high bandwidth of the AD9886, sometimes low-pass filtering the analog inputs can help to reduce noise. (For many applications, filtering is unnecessary.) Experiments have shown that placing a series ferrite bead prior to the 75  $\Omega$  termination resistor is helpful in filtering out excess noise. Specifically, the part used was the # 2508051217Z0 from Fair-Rite, but each application may work best with a different bead value. Alternately, placing a 100  $\Omega$  to 120  $\Omega$  resistor between the 75  $\Omega$  termination resistor and the input coupling capacitor can also benefit.

### Digital Interface Inputs

Many of the same techniques that are recommended for the analog interface inputs should also be used for the digital interface inputs. Most important is to minimize trace lengths, and then to make the input traces impedances match the input termination (typically 50  $\Omega$ ).

### Power Supply Bypassing

It is recommended to bypass each power supply pin with a 0.1  $\mu\text{F}$  capacitor. The exception is in the case where two or more supply pins are adjacent to each other. For these groupings of powers/grounds, it is only necessary to have one bypass capacitor. The fundamental idea is to have a bypass capacitor within about 0.5 cm of each power pin. Also, avoid placing the capacitor on the opposite side of the PC board from the AD9886, as that interposes resistive vias in the path.

The bypass capacitors should be physically located between the power plane and the power pin. Current should flow from the power plane => capacitor => power pin. Do not make the power connection between the capacitor and the power pin. Placing a via underneath the capacitor pads, down to the power plane, is generally the best approach.

It is particularly important to maintain low noise and good stability of  $\text{PV}_\text{D}$  (the clock generator supply). Abrupt changes in  $\text{PV}_\text{D}$  can result in similarly abrupt changes in sampling clock

phase and frequency. This can be avoided by careful attention to regulation, filtering, and bypassing. It is highly desirable to provide separate regulated supplies for each of the analog circuitry groups ( $\text{V}_\text{D}$  and  $\text{PVD}$ ).

Some graphic controllers use substantially different levels of power when active (during active picture time) and when idle (during horizontal and vertical sync periods). This can result in a measurable change in the voltage supplied to the analog supply regulator, which can in turn produce changes in the regulated analog supply voltage. This can be mitigated by regulating the analog supply, or at least  $\text{PV}_\text{D}$ , from a different, cleaner power source (for example, from a 12 V supply).

It is also recommend to use a single ground plane for the entire board. Experience has repeatedly shown that the noise performance is the same or better with a single ground plane. Using multiple ground planes can be detrimental because each separate ground plane is smaller, and long ground loops can result.

In some cases, using separate ground planes is unavoidable. For those cases, it is recommend to at least place a single ground plane under the AD9886. The location of the split should be at the receiver of the digital outputs. For this case it is even more important to place components wisely because the current loops will be much longer (current takes the path of least resistance). An example of a current loop: power plane => AD9886 => digital output trace => digital data receiver => digital ground plane => analog ground plane.

### PLL

Place the PLL loop filter components as close to the  $\text{FILT}$  pin as possible.

Do not place any digital or other high frequency traces near these components.

Use the values suggested in the data sheet with 10% tolerances or less.

### Outputs (Both Data and Clocks)

Try to minimize the trace length that the digital outputs have to drive. Longer traces have higher capacitance, which require more current that causes more internal digital noise.

Shorter traces reduce the possibility of reflections.

Adding a series resistor of value 50  $\Omega$ –200  $\Omega$  can suppress reflections, reduce EMI, and reduce the current spikes inside of the AD9886. If series resistors are used, place them as close to the AD9886 pins as possible (try not to add vias or extra length to the output trace in order to get the resistors closer).

If possible, limit the capacitance that each of the digital outputs drives to less than 10 pF. This can easily be accomplished by keeping traces short and by connecting the outputs to only one device. Loading the outputs with excessive capacitance will increase the current transients inside of the AD9886 creating more digital noise on its power supplies.

### Digital Inputs

The digital inputs on the AD9886 were designed to work with 3.3 V signals.

Any noise that gets onto the Hsync input trace will add jitter to the system. Therefore, minimize the trace length and do not run any digital or other high frequency traces near it.

# AD9886

## Voltage Reference

Bypass with a 0.1  $\mu$ F capacitor. Place as close to the AD9886 pin as possible. Make the ground connection as short as possible.

REFOUT is easily connected to REFIN with a short trace. Avoid making this trace any longer than it needs to be.

When using an external reference. The REFOUT output, while unused, still needs to be bypassed with a 0.1  $\mu$ F capacitor in order to avoid ringing.

## OUTLINE DIMENSIONS

Dimensions shown in inches and (mm).

### 160-Lead MQFP (S-160)

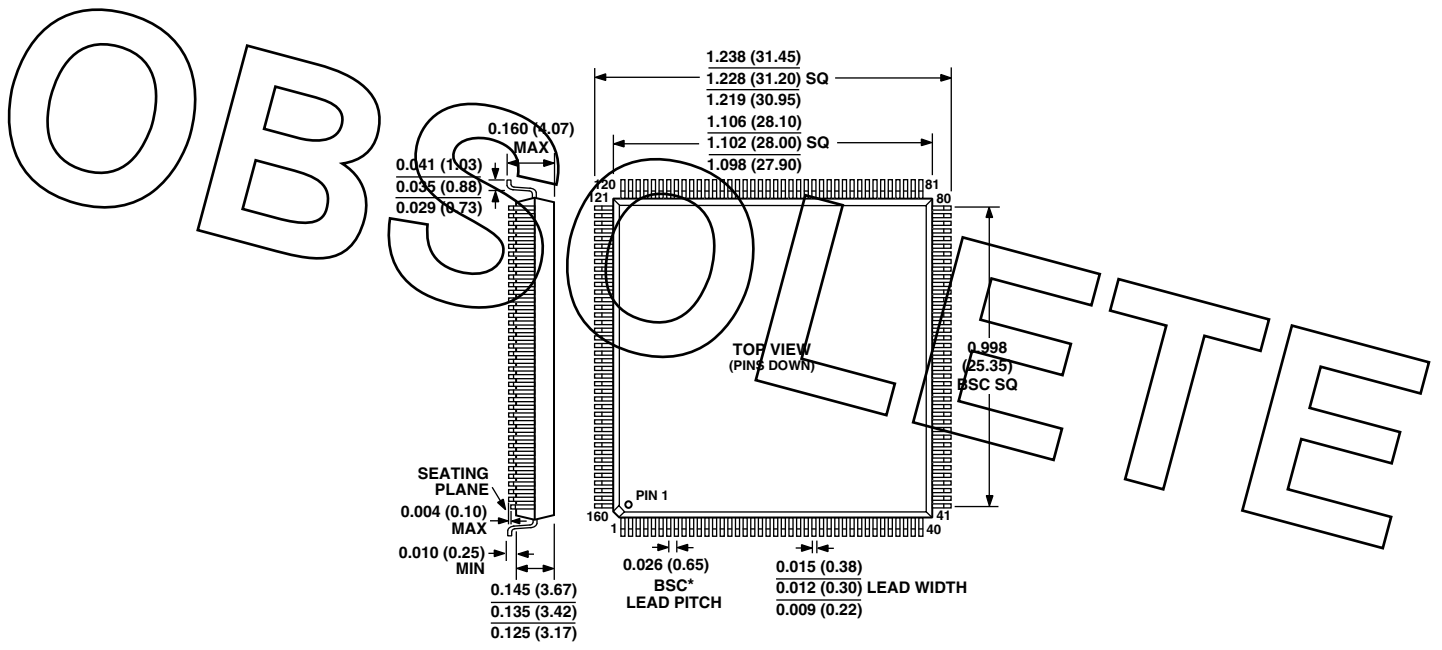

\* THE ACTUAL POSITION OF EACH LEAD IS WITHIN 0.0047 (0.12) FROM ITS IDEAL POSITION WHEN MEASURED IN THE LATERAL DIRECTION. CENTER FIGURES ARE TYPICAL UNLESS OTHERWISE NOTED.