

PD60-4H-1461-CoE Hardware Manual

Hardware Version V1.10 | Document Revision V1.20 • 2022-SEP-14

PD60-4H-1461-CoE is a single axis stepper motor servo drive for up to +48V supply voltage and up to 3Nm torque. A built-in magnetic encoder is used for closed loop operation of the motor. The module communicates using the CANOpen over EtherCAT® protocol. The PD60-4H-1461-CoE comes with a housing and can be interfaced with M8 type connectors.



Features

- Supply Voltage +24 to +48V DC
- Up to 3Nm
- Field Oriented Control (FOC) of the stepper motor
- Integrated position feedback
- EtherCAT® interface
- CoE protocol
- NEMA24 size stepper motor
- Housing



Applications

- Lab-Automation
- Robotics
- CNC
- Manufacturing
- Factory Automation

Simplified Block Diagram

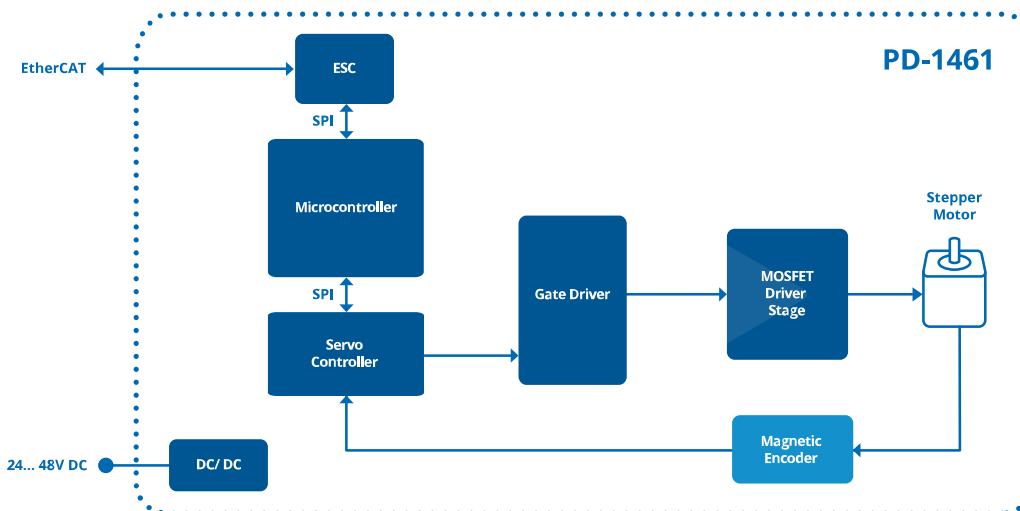

Contents

1	Features	3
2	Order Codes	4
3	Mechanical and Electrical Interfacing	5
3.1	Module Size	5
3.2	Supply Buffering	6
4	Connectors and Signals	7
4.1	Supply Connector C1	8
4.2	EtherCAT IN Port Connector C2	9
4.3	EtherCAT OUT Port Connector C3	10
4.4	LEDs Signals	11
5	Operational Ratings and Characteristics	12
5.1	Absolute Maximum Ratings	12
5.2	Operational Ratings (Ambient Temperature 25°C)	12
5.3	Other Requirements	12
5.4	Torque curve	13
6	Figures Index	14
7	Tables Index	15
8	Supplemental Directives	16
8.1	Producer Information	16
8.2	Copyright	16
8.3	Trademark Designations and Symbols	16
8.4	Target User	16
8.5	Disclaimer: Life Support Systems	16
8.6	Disclaimer: Intended Use	16
8.7	Collateral Documents & Tools	17
9	Revision History	18
9.1	Hardware Revision	18
9.2	Document Revision	18

1 Features

PD60-4H-1461-CoE is a single axis stepper motor servo drive for up to +48V supply voltage and ca. 3Nm torque. A built-in magnetic encoder is used for closed loop operation of the motor. The module communicates using the CANopen over EtherCAT® protocol. The PD60-4H-1461-CoE comes with a housing and can be interfaced with M8 type connectors.

Controller & Driver

- Motor current: up to 9A RMS
- Supply voltage: +24...+48V DC (nominal)
- Closed loop / FOC stepper motor operation
- Integrated Hall position sensor with a resolution of 16384
- Temperature rating: -30...+60° (standard version)

Interface and IO

- 1x M8 power input connector
- 1x EtherCAT interface
 - 1x M8 EtherCAT IN port
 - 1x M8 EtherCAT OUT port

Mechanical data

- Max. dimension: 152.5mm x 64mm x 73mm (L/W/H)
- Weight: ca. 1.6kg
- NEMA24 sized stepper motor with up to 3Nm
- Forced cooling via housing and motor

Software

- CANopen-over-EtherCAT (COE) with DS402 standard protocol stack. Please see PD60-4H-1461-CoE COE firmware manual for more details.

2 Order Codes

Order Code	Description	Size (LxWxH)
PD60-4H-1461-CoE	Stepper Motor Servo Drive, CANopen-over-EtherCAT firmware, housing, M8 connectors, Weight: ca. 1.6kg	152mm x 64mm x 73mm

Table 1: PD60-4H-1461-CoE Order Codes

A cable loom set is available for this module:

Order Code	Description
PD-1461-CABLE	Cable loom for PD60-4H-1461-CoE : <ul style="list-style-type: none"> • 1x M8 cable for connecting to master (M8-RJ45) • 1x M8 cable for connecting multiple M8 drives (M8-M8) • 1x M8 cable for power (M8-open leads)

Table 2: PD60-4H-1461-CoE Cable Loom

3 Mechanical and Electrical Interfacing

3.1 Module Size

The PD60-4H-1461-CoE comes potted inside an aluminum housing with an overall size of 152.5mm (overall length including shaft) x 64mm (width) x 73mm (height).

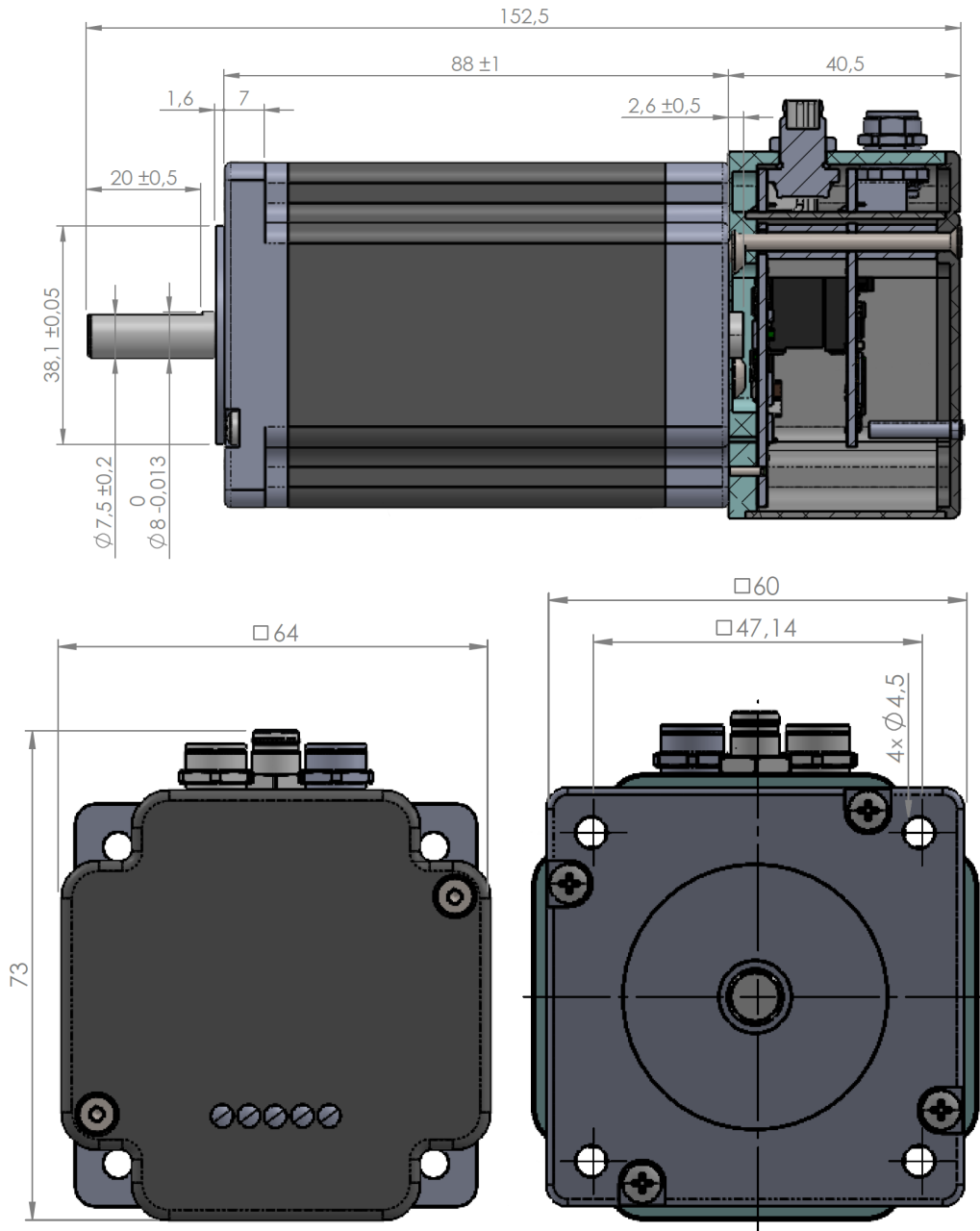

Figure 1: PD60-4H-1461-CoE Dimensions (all values in mm. Not for scale!)

3.2 Supply Buffering

PD60-4H-1461-CoE includes limited onboard capacitance of ca. 450uF. Depending on your application and power supply make sure to add sufficient capacitors to the driver input to stabilize supply. Low ESR electrolyte caps are recommended to be connected to the power supply lines as close as possible to the drives.

Rule of thumb for sizing the capacitance: $C = 1000 \frac{\mu F}{A} * I_{SUPPLY}$ with $I_{SUPPLY} = I_{rms} * \sqrt{2}$

The capacitors should be selected with regard to high ripple current rating and providing enough headroom regarding the voltage rating. In addition to power stabilization (buffer) and filtering this added capacitor will also reduce any voltage spikes which might otherwise occur from a combination of high inductance power supply wires and the ceramic capacitors. In addition, it will limit slew-rate of power supply voltage at the module.

In addition, a regulated power supply is highly recommended.

4 Connectors and Signals

The PD60-4H-1461-CoE has 3 connectors altogether.

NOTICE

Start with power supply OFF and do not connect or disconnect motor during operation! Motor cable and motor inductance might lead to voltage spikes when the motor is (dis)connected while energized. These voltage spikes might exceed voltage limits of the driver MOSFETs and might permanently damage them. Therefore, always switch off / disconnect power supply or at least disable driver stage before connecting / disconnecting motor.

NOTICE

Take care of polarity, wrong polarity can destroy the board!

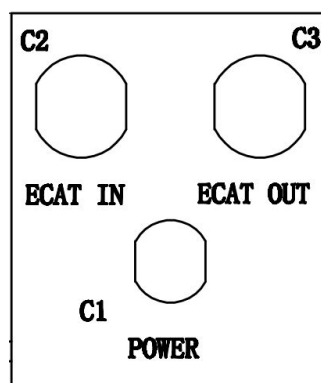

Figure 2: PD60-4H-1461-CoE side connectors (M8 type)

Connector	Description	Type
C1	Power supply	M8, 4-pin, male, A-coding, Binder Series 718, PN 866319112100004
C2	EtherCAT IN port	M8, 4-pin, female, A-coding, Binder Series 718, PN 866618112100004
C3	EtherCAT OUT port	M8, 4-pin, female, A-coding, Binder Series 718, PN 866618112100004

Table 3: PD60-4H-1461-CoE connectors

4.1 Supply Connector C1

Type: M8, 4-pin, male, A-coding
Manufacturer: Binder
PN: 866319112100004, Series 718

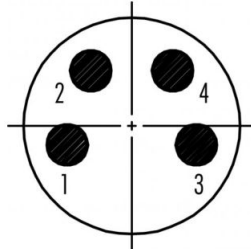

Figure 3: M8 power connector pins

Pin	Signal	Description
1	GND	Supply ground
2	GND	Supply ground
3	+VM	Main drive supply, +24V...+48V DC
4	+VM	Main drive supply, +24V...+48V DC

Table 4: Supply connector C1

4.2 EtherCAT IN Port Connector C2

Type: M8, 4-pin, female, A-coding
Manufacturer: Binder
PN: 866618112100004, Series 718

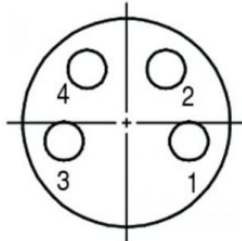

Figure 4: M8 EtherCAT IN pins

Pin	Signal	Description
1	TD+	Transmit Data Plus, positive signal for the TD differential pair
2	RD+	Receive Data Plus, positive signal for the RD differential pair
3	RD-	Receive Data Minus, negative signal for the RD differential pair
4	TD-	Transmit Data Minus, negative signal for the TD differential pair

Table 5: EtherCAT IN connector C2

4.3 EtherCAT OUT Port Connector C3

Type: M8, 4-pin, female, A-coding
 Manufacturer: Binder
 PN: 866618112100004, Series 718

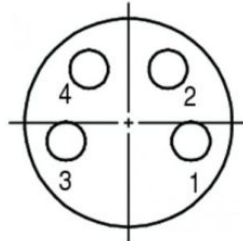

Figure 5: M8 EtherCAT OUT pins

Pin	Signal	Description
1	TD+	Transmit Data Plus, positive signal for the TD differential pair
2	RD+	Receive Data Plus, positive signal for the RD differential pair
3	RD-	Receive Data Minus, negative signal for the RD differential pair
4	TD-	Transmit Data Minus, negative signal for the TD differential pair

Table 6: EtherCAT OUT connector C3

4.4 LEDs Signals

The PD60-4H-1461-CoE has 5 LEDs on the top side of the housing as given in the following drawing.

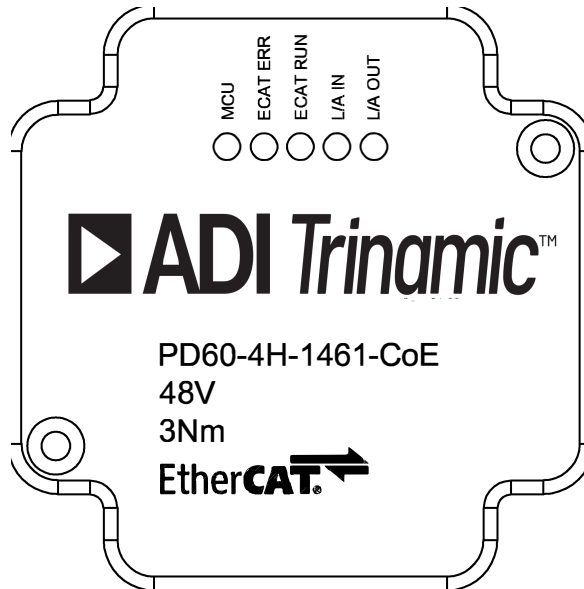

Figure 6: PD60-4H-1461-CoE LEDs

LED Name	Description	Comment
MCU	MCU status LED / heart beat	Green LED
L/A IN	EtherCAT link IN status and activity	Green LED
L/A OUT	EtherCAT link OUT status and activity	Green LED
ECAT RUN	EtherCAT state machine RUN LED	Green LED
ECAT ERR	EtherCAT state machine ERR LED	Red LED

Table 7: PD60-4H-1461-CoE LEDs

5 Operational Ratings and Characteristics

5.1 Absolute Maximum Ratings

Parameter	Symbol	Min	Abs. Max	Unit
Driver supply voltage	$+VM$	-0.5	+56	V
Working temperature range	T_A	-30	+60	° C
Storage temperature range	T_S	-30	+60	° C

Table 8: Absolute maximum ratings

NOTICE

Stresses above those listed under "Absolute Maximum Ratings" may cause permanent damage to the device. This is a stress rating only and functional operation of the device at those or any other conditions above those indicated in the operation listings of this specification is not implied. Exposure to maximum rating conditions for extended periods may affect device reliability.

5.2 Operational Ratings (Ambient Temperature 25°C)

Parameter	Symbol	Min	Typ	Max	Unit
Driver supply voltage	$+VM$	+24		+48	V
Ambient temperature	T_A		+25		° C

Table 9: Operational ratings

5.3 Other Requirements

Specifications	Description or Value
Cooling	Free air or heat sink mounted depending on application and duty cycle
Working environment	Avoid dust, water, oil mist and corrosive gases, no condensation, no frosting

Table 10: Other requirements and characteristics

¹ This is the maximum current rating. This is not for continuous operation but depends on duty cycle, ambient temperature, and cooling.

5.4 Torque curve

The maximum torque of ca. 3 Nm can be reached in standstill operation.

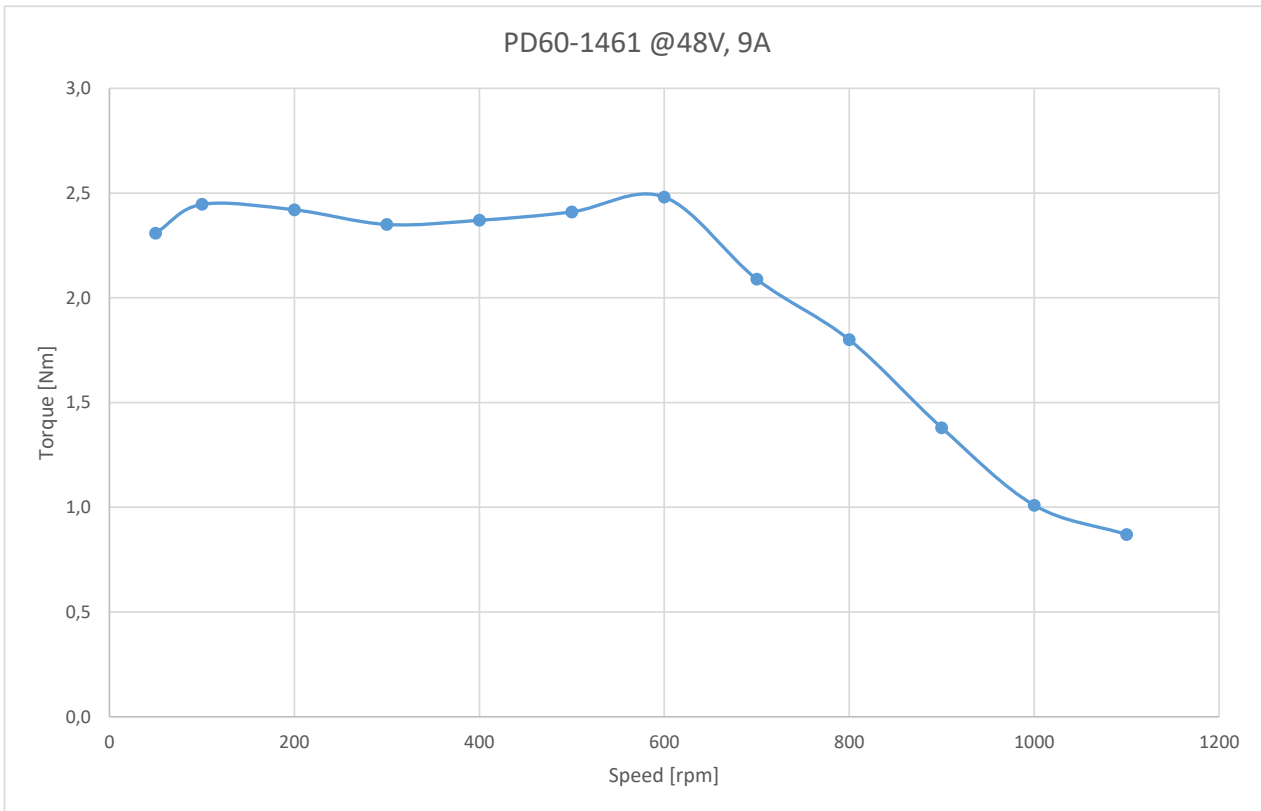

Figure 7: PD60-4H-1461-CoE Torque curve closed-loop at 48V and 9A.

6 Figures Index

1	PD60-4H-1461-CoE Dimensions	5	5	M8 EtherCAT OUT pins	10
2	PD60-4H-1461-CoE side connectors	7	6	PD60-4H-1461-CoE LEDs	11
3	M8 power connector pins	8	7	PD60-4H-1461-CoE Torque curve	13
4	M8 EtherCAT IN pins	9			

7 Tables Index

1	PD60-4H-1461-CoE Order Codes	4	7	PD60-4H-1461-CoE LEDs	11
2	PD60-4H-1461-CoE Cable Loom	4	8	Absolute maximum ratings	12
3	PD60-4H-1461-CoE connectors	7	9	Operational ratings	12
4	Supply connector C1	8	10	Other requirements and characteristics	12
5	EtherCAT IN connector C2	9	11	Hardware Revision	18
6	EtherCAT OUT connector C3	10	12	Document Revision	18

8 Supplemental Directives

8.1 Producer Information

8.2 Copyright

TRINAMIC owns the content of this user manual in its entirety, including but not limited to pictures, logos, trademarks, and resources. © Copyright 2022 TRINAMIC. All rights reserved. Electronically published by TRINAMIC, Germany.

Redistribution of sources or derived formats (for example, Portable Document Format or Hypertext Markup Language) must retain the above copyright notice, and the complete data sheet, user manual, and documentation of this product including associated application notes; and a reference to other available product-related documentation.

8.3 Trademark Designations and Symbols

Trademark designations and symbols used in this documentation indicate that a product or feature is owned and registered as trademark and/or patent either by TRINAMIC or by other manufacturers, whose products are used or referred to in combination with TRINAMIC's products and TRINAMIC's product documentation.

This Hardware Manual is a non-commercial publication that seeks to provide concise scientific and technical user information to the target user. Thus, trademark designations and symbols are only entered in the Short Spec of this document that introduces the product at a quick glance. The trademark designation /symbol is also entered when the product or feature name occurs for the first time in the document. All trademarks and brand names used are property of their respective owners.

8.4 Target User

The documentation provided here, is for programmers and engineers only, who are equipped with the necessary skills and have been trained to work with this type of product.

The Target User knows how to responsibly make use of this product without causing harm to himself or others, and without causing damage to systems or devices, in which the user incorporates the product.

8.5 Disclaimer: Life Support Systems

TRINAMIC Motion Control GmbH & Co. KG does not authorize or warrant any of its products for use in life support systems, without the specific written consent of TRINAMIC Motion Control GmbH & Co. KG.

Life support systems are equipment intended to support or sustain life, and whose failure to perform, when properly used in accordance with instructions provided, can be reasonably expected to result in personal injury or death.

Information given in this document is believed to be accurate and reliable. However, no responsibility is assumed for the consequences of its use nor for any infringement of patents or other rights of third parties which may result from its use. Specifications are subject to change without notice.

8.6 Disclaimer: Intended Use

The data specified in this user manual is intended solely for the purpose of product description. No representations or warranties, either express or implied, of merchantability, fitness for a particular purpose

or of any other nature are made hereunder with respect to information/specification or the products to which information refers and no guarantee with respect to compliance to the intended use is given.

In particular, this also applies to the stated possible applications or areas of applications of the product. TRINAMIC products are not designed for and must not be used in connection with any applications where the failure of such products would reasonably be expected to result in significant personal injury or death (safety-Critical Applications) without TRINAMIC's specific written consent.

TRINAMIC products are not designed nor intended for use in military or aerospace applications or environments or in automotive applications unless specifically designated for such use by TRINAMIC. TRINAMIC conveys no patent, copyright, mask work right or other trade mark right to this product. TRINAMIC assumes no liability for any patent and/or other trade mark rights of a third party resulting from processing or handling of the product and/or any other use of the product.

8.7 Collateral Documents & Tools

This product documentation is related and/or associated with additional tool kits, firmware and other items, as provided on the product page at: www.trinamic.com.

9 Revision History

9.1 Hardware Revision

Version	Date	Author	Description
V1.10	2021-JAN-10	MM/SK	Release Version

Table 11: Hardware Revision

9.2 Document Revision

Version	Date	Author	Description
V1.00	2022-JAN-04	SK	First release.
V1.10	2022-JUL-19	FV	Updated Features, Drawing and Torque curve.
V1.20	2022-SEP-14	FV	Updated product picture.

Table 12: Document Revision