

# ADA-4543

## Silicon Bipolar Darlington Amplifier



### Data Sheet

#### Description

Avago Technologies' ADA-4543 is an economical, easy-to-use, general purpose silicon bipolar RFIC gain block amplifiers housed in a 4-lead SC-70 (SOT-343) surface mount plastic package which requires only half the board space of a SOT-143 package.

The Darlington feedback structure provides inherent broad bandwidth performance, resulting in useful operating frequency up to 2.5 GHz. This is an ideal device for small-signal gain cascades or IF amplification.

ADA-4543 is fabricated using Avago's HP25 silicon bipolar process, which employs a double-diffused single polysilicon process with self-aligned submicron emitter geometry. The process is capable of simultaneous high  $f_T$  and high NPN breakdown (25 GHz  $f_T$  at 6V BVCEO). The process utilizes industry standard device oxide isolation technologies and submicron aluminum multilayer interconnect to achieve superior performance, high uniformity, and proven reliability.

#### Surface Mount Package SOT-343

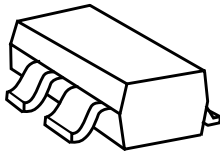

#### Pin Connections and Package Marking

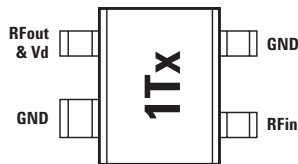

#### Note:

Top View. Package marking provides orientation and identification.

"1T" = Device Code

"x" = Date code character identifies month of manufacture.

#### Features

- Small Signal gain amplifier
- Operating frequency DC – 2.5 GHz
- Unconditionally stable
- 50 Ohms input & output
- Flat, Broadband Frequency Response up to 1 GHz
- Operating Current: 10 to 30 mA
- Industry standard SOT-343 package
- Lead-free option available

#### Specifications

##### 900 MHz, 3.4V, 15 mA (typ.)

- 15.1 dB associated gain
- 1.9 dBm  $P_{1dB}$
- 15 dBm  $OIP_3$
- 3.7 dB noise figure
- VSWR < 2 throughput operating frequency
- Single supply, typical  $I_d = 15$  mA

#### Applications

- Cellular/PCS/WLL base stations
- Wireless data/WLAN
- Fiber-optic systems
- ISM



#### Attention:

Observe precautions for handling electrostatic sensitive devices.

#### ESD Machine Model (Class A)

#### ESD Human Body Model (Class 1B)

Refer to Avago Application Note A004R: Electrostatic Discharge Damage and Control.

#### Typical Biasing Configuration

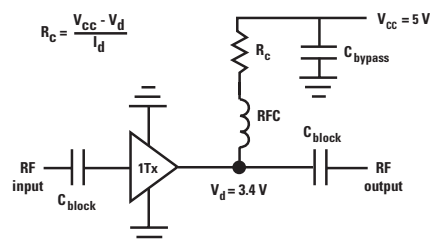

## ADA-4543 Absolute Maximum Ratings<sup>[1]</sup>

| Symbol         | Parameter                              | Units | Absolute Maximum |
|----------------|--|-------|------------------|
| $I_d$          | Device Current                         | mA    | 40               |
| $P_{diss}$     | Total Power Dissipation <sup>[2]</sup> | mW    | 145              |
| $P_{in\ max.}$ | RF Input Power                         | dBm   | 13               |
| $T_j$          | Channel Temperature                    | °C    | 150              |
| $T_{STG}$      | Storage Temperature                    | °C    | -65 to 150       |
| $\theta_{jc}$  | Thermal Resistance <sup>[3]</sup>      | °C/W  | 152              |

### Notes:

1. Operation of this device above any one of these parameters may cause permanent damage.
2. Ground lead temperature is 25°C. Derate 6.6 mW/°C for  $T_L > 128^\circ\text{C}$ .
3. Junction-to-case thermal resistance measured using 150°C Liquid Crystal Measurement method.

## ADA-4543 Electrical Specifications

$T_A = 25^\circ\text{C}$ ,  $Z_0 = 50\Omega$ ,  $P_{in} = -25\ \text{dBm}$ ,  $I_d = 15\ \text{mA}$  (unless specified otherwise)

| Symbol       | Parameter and Test Condition:<br>$I_d = 15\ \text{mA}$ , $Z_0 = 50\Omega$ | Frequency  | Units | Min. | Typ.         | Max. | Std. Dev.    |
|--------------|---|--|-------|------|--------------|------|--------------|
| $V_d$        | Device Voltage $I_d = 15\ \text{mA}$                                      |  | V     | 3.1  | 3.4          | 3.8  |              |
| $G_p$        | Power Gain ( $ S_{21} ^2$ )   | 100 MHz<br>900 MHz <sup>[1,2]</sup>                  | dB    | 13.5 | 15.7<br>15.1 | 16.5 |              |
| $\Delta G_p$ | Gain Flatness   | 100 to 900 MHz<br>0.1 to 2 GHz                       | dB    |      | 0.4<br>1.5   |      |              |
| $F_{3dB}$    | 3 dB Bandwidth  |  | GHz   |      | 3.6          |      |              |
| $VSWR_{in}$  | Input Voltage Standing Wave Ratio   | 0.1 to 6 GHz   |       |      | 1.7:1        |      |              |
| $VSWR_{out}$ | Output Voltage Standing Wave Ratio  | 0.1 to 6 GHz   |       |      | 1.3:1        |      |              |
| NF           | 50Ω Noise Figure  | 100 MHz<br>900 MHz <sup>[1,2]</sup>                  | dB    |      | 3.6<br>3.7   |      | 0.16<br>0.18 |
| $P_{1dB}$    | Output Power at 1dB Gain Compression                                      | 100 MHz<br>900 MHz <sup>[1,2]</sup>                  | dBm   |      | 2.5<br>1.9   |      |              |
| $OIP_3$      | Output 3 <sup>rd</sup> Order Intercept Point                              | 100 MHz <sup>[3]</sup><br>900 MHz <sup>[1,2,3]</sup> | dBm   |      | 14.6<br>15.0 |      |              |
| DV/dT        | Device Voltage Temperature Coefficient                                    |  | mV/°C |      | -5.6         |      |              |

### Notes:

1. Typical value determined from a sample size of 500 parts from 3 wafers.
2. Measurement obtained using production test board described in the block diagram below.
3. I) 900 MHz  $OIP_3$  test condition:  $F_1 = 900\ \text{MHz}$ ,  $F_2 = 905\ \text{MHz}$  and  $P_{in} = -25\ \text{dBm}$  per tone.  
II) 100 MHz  $OIP_3$  test condition:  $F_1 = 100\ \text{MHz}$ ,  $F_2 = 105\ \text{MHz}$  and  $P_{in} = -25\ \text{dBm}$  per tone.

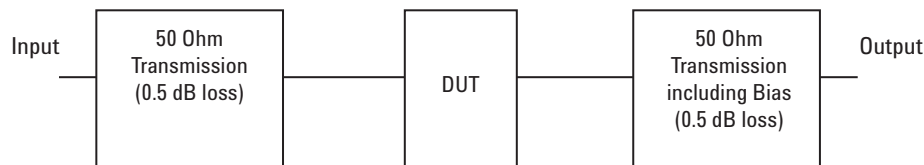

Block diagram of 900 MHz production test board used for  $V_d$ , Gain,  $P_{1dB}$ ,  $OIP_3$ , and NF measurements. Circuit losses have been de-embedded from actual measurements.

**Product Consistency Distribution Charts at 900 MHz,  $I_d = 15$  mA**

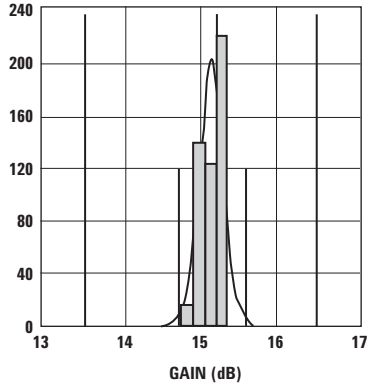

**Figure 1. Gain distribution @ 15 mA.**  
LSL = 13.5, Nominal = 15.1, USL = 16.5

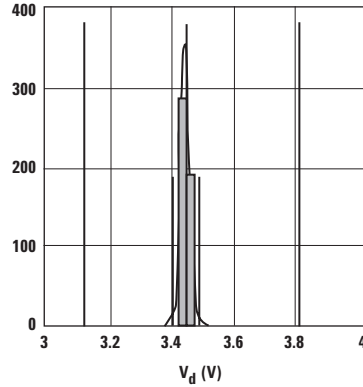
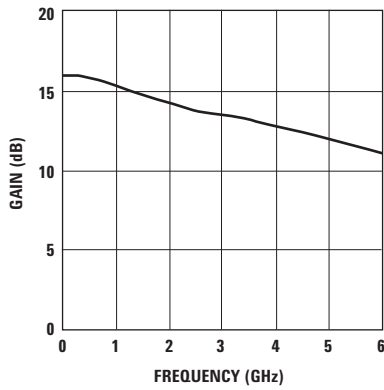

**Figure 2.  $V_d$  distribution @ 15 mA.**  
LSL = 3.1, Nominal = 3.4, USL = 3.8

**Notes:**

1. Statistics distribution determined from a sample size of 500 parts taken from 3 different wafers.
2. Future wafers allocated to this product may have typical values anywhere between the minimum and maximum specification limits.

**ADA-4543 Typical Performance Curves (at 25°C, unless specified otherwise)**



**Figure 3. Gain vs. Frequency at  $I_d = 15$  mA.**

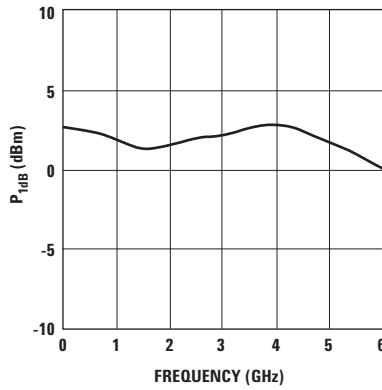

**Figure 4.  $P_{1dB}$  vs. Frequency at  $I_d = 15$  mA.**

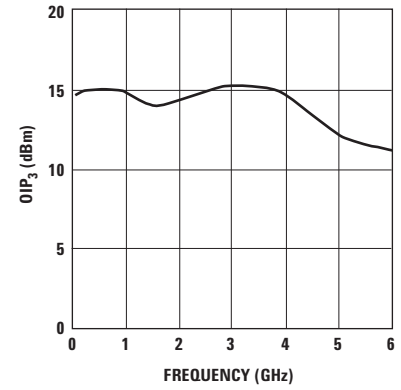

**Figure 5.  $OIP_3$  vs. Frequency at  $I_d = 15$  mA.**

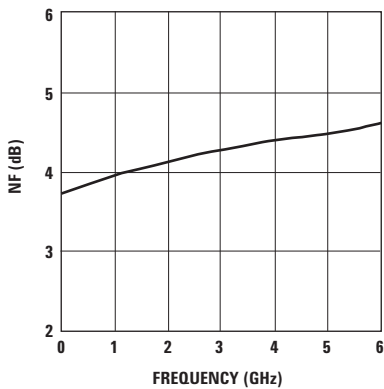

**Figure 6. NF vs Frequency at  $I_d = 15$  mA.**

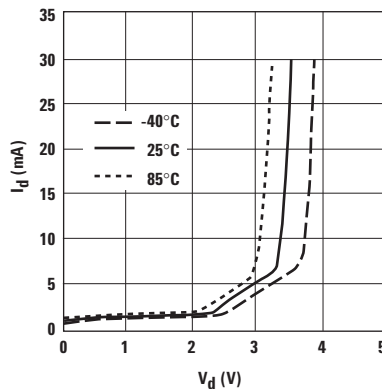

**Figure 7.  $I_d$  vs.  $V_d$  and Temperature.**

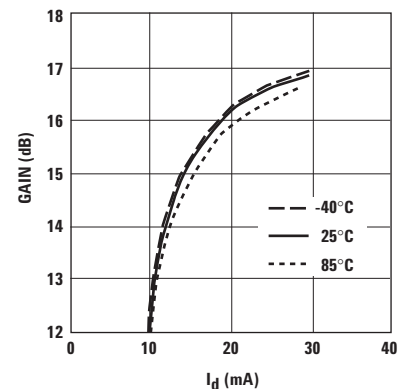

**Figure 8. Gain vs.  $I_d$  and Temperature at 900 MHz.**

ADA-4543 Typical Performance Curves (at 25°C, unless specified otherwise), continued

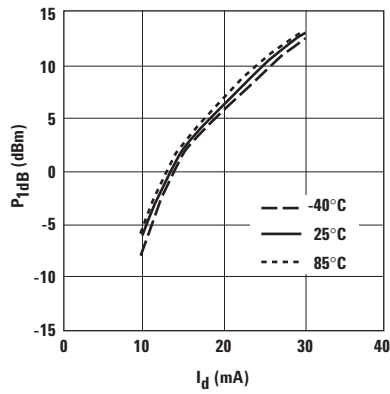

Figure 9. P<sub>1dB</sub> vs. I<sub>d</sub> and Temperature at 900 MHz.

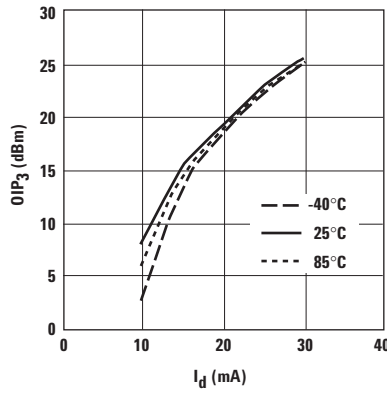

Figure 10. OIP<sub>3</sub> vs. I<sub>d</sub> and Temperature at 900 MHz.

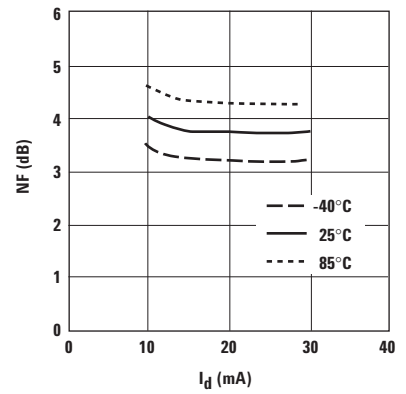

Figure 11. NF vs. I<sub>d</sub> and Temperature at 900 MHz.

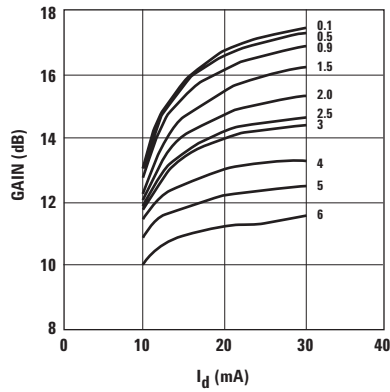

Figure 12. Gain vs. I<sub>d</sub> and Frequency (GHz).

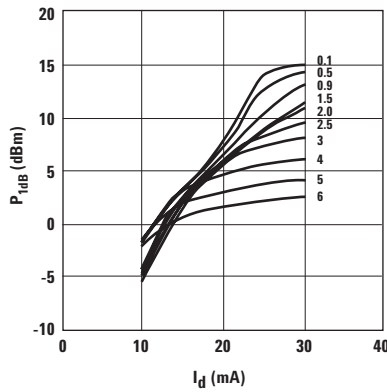

Figure 13. P<sub>1dB</sub> vs. I<sub>d</sub> and Frequency (GHz).

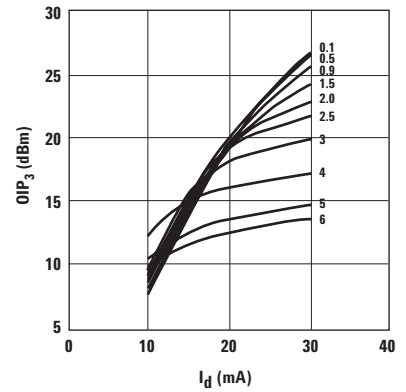

Figure 14. OIP<sub>3</sub> vs. I<sub>d</sub> and Frequency (GHz).

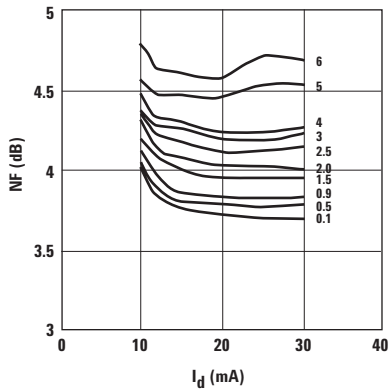

Figure 15. NF vs. I<sub>d</sub> and Frequency (GHz).

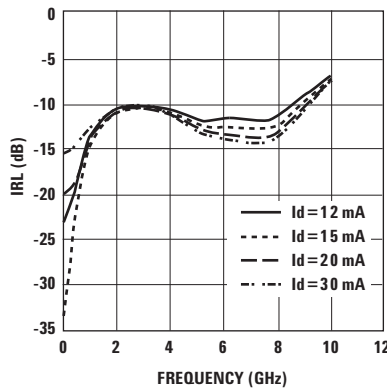

Figure 16. Input Return Loss vs. I<sub>d</sub> and Frequency (GHz).

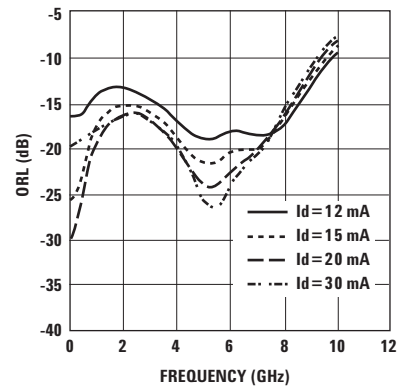

Figure 17. Output Return Loss vs. I<sub>d</sub> and Frequency (GHz).

**ADA-4543 Typical Scattering Parameters,  $T_A = 25^\circ\text{C}$ ,  $I_d = 12\text{ mA}$**

| Freq.<br>GHz | $S_{11}$ |        | dB    | $S_{21}$ |       | $S_{12}$ |       | $S_{22}$ |        | K   |
|--------------|----------|--------|-------|----------|-------|----------|-------|----------|--------|-----|
|              | Mag.     | Ang.   |       | Mag.     | Ang.  | Mag.     | Ang.  | Mag.     | Ang.   |     |
| 0.1          | 0.071    | 4.9    | 14.38 | 5.234    | 176.2 | 0.125    | -0.9  | 0.146    | -3.2   | 1.1 |
| 0.5          | 0.112    | 24.8   | 14.24 | 5.15     | 162.1 | 0.123    | -4.6  | 0.15     | -3.8   | 1.1 |
| 0.9          | 0.184    | 24.2   | 13.98 | 4.998    | 148.3 | 0.12     | -7.6  | 0.183    | -6     | 1.1 |
| 1.0          | 0.198    | 21.6   | 13.90 | 4.956    | 144.9 | 0.119    | -8.3  | 0.191    | -7.7   | 1.1 |
| 1.5          | 0.257    | 5.9    | 13.51 | 4.735    | 129.3 | 0.116    | -10.9 | 0.207    | -18.7  | 1.1 |
| 1.9          | 0.282    | -4.5   | 13.15 | 4.547    | 117.1 | 0.113    | -12.6 | 0.213    | -27.2  | 1.2 |
| 2.0          | 0.29     | -7.8   | 13.09 | 4.513    | 114.2 | 0.113    | -13.1 | 0.212    | -29.1  | 1.2 |
| 2.5          | 0.307    | -19.4  | 12.72 | 4.326    | 99.8  | 0.111    | -14.8 | 0.203    | -38    | 1.2 |
| 3.0          | 0.31     | -30.7  | 12.40 | 4.168    | 85.9  | 0.109    | -16.1 | 0.185    | -46.8  | 1.2 |
| 3.5          | 0.303    | -43.3  | 12.07 | 4.013    | 72.2  | 0.109    | -17.2 | 0.162    | -57    | 1.3 |
| 4.0          | 0.287    | -58    | 11.74 | 3.865    | 58.5  | 0.109    | -18   | 0.139    | -69.3  | 1.3 |
| 4.5          | 0.273    | -74.8  | 11.45 | 3.736    | 45    | 0.111    | -18.5 | 0.12     | -87    | 1.3 |
| 5.0          | 0.258    | -94.3  | 11.05 | 3.568    | 31.4  | 0.113    | -19.2 | 0.11     | -106.9 | 1.4 |
| 5.5          | 0.253    | -116.3 | 10.67 | 3.416    | 18.2  | 0.118    | -19.8 | 0.114    | -126.3 | 1.4 |
| 6.0          | 0.259    | -136.7 | 10.24 | 3.251    | 5     | 0.125    | -21   | 0.122    | -144.9 | 1.3 |
| 6.5          | 0.254    | -156.4 | 9.83  | 3.101    | -7.7  | 0.135    | -22.8 | 0.121    | -163.1 | 1.3 |
| 7.0          | 0.25     | -177.8 | 9.43  | 2.961    | -20.5 | 0.148    | -26.1 | 0.116    | 173.8  | 1.3 |
| 7.5          | 0.25     | 157    | 8.97  | 2.81     | -33.5 | 0.161    | -31.1 | 0.116    | 143.7  | 1.2 |
| 8.0          | 0.266    | 131    | 8.45  | 2.645    | -46.4 | 0.172    | -37.1 | 0.134    | 111.8  | 1.2 |
| 8.5          | 0.294    | 106.9  | 7.79  | 2.453    | -59.1 | 0.181    | -43.2 | 0.171    | 87.5   | 1.2 |
| 9.0          | 0.346    | 87.1   | 7.17  | 2.284    | -71   | 0.192    | -49   | 0.223    | 71.6   | 1.2 |
| 9.5          | 0.399    | 70.1   | 6.39  | 2.088    | -83.5 | 0.204    | -55.7 | 0.281    | 60.3   | 1.1 |
| 10.0         | 0.454    | 57.4   | 5.73  | 1.935    | -94.8 | 0.213    | -62.9 | 0.339    | 50.8   | 1.1 |

**Notes:**

1. S-parameters are measured on a microstrip line made on 0.025 inch thick alumina carrier. The input reference plane is at the end of the input lead. The output reference plane is at the end of the output lead.

**ADA-4543 Typical Scattering Parameters,  $T_A = 25^\circ\text{C}$ ,  $I_d = 15\text{ mA}$**

| Freq.<br>GHz | $S_{11}$ |        | dB    | $S_{21}$ |       | $S_{12}$ |       | $S_{22}$ |        | K   |
|--------------|----------|--------|-------|----------|-------|----------|-------|----------|--------|-----|
|              | Mag.     | Ang.   |       | Mag.     | Ang.  | Mag.     | Ang.  | Mag.     | Ang.   |     |
| 0.1          | 0.023    | 141.7  | 15.60 | 6.026    | 176   | 0.114    | -0.6  | 0.051    | -0.8   | 1.1 |
| 0.5          | 0.083    | 76.9   | 15.46 | 5.928    | 161.4 | 0.113    | -3.2  | 0.068    | 18.9   | 1.1 |
| 0.9          | 0.165    | 51.8   | 15.20 | 5.753    | 147   | 0.111    | -5.6  | 0.118    | 15.2   | 1.1 |
| 1.0          | 0.18     | 46.4   | 15.12 | 5.702    | 143.4 | 0.111    | -6.2  | 0.129    | 12.3   | 1.1 |
| 1.5          | 0.238    | 22.4   | 14.63 | 5.389    | 127   | 0.109    | -8.7  | 0.155    | -2.1   | 1.1 |
| 1.9          | 0.265    | 8.8    | 14.19 | 5.12     | 114.3 | 0.108    | -10.3 | 0.166    | -12.2  | 1.1 |
| 2.0          | 0.272    | 5.1    | 14.09 | 5.066    | 111.3 | 0.107    | -10.7 | 0.167    | -14.2  | 1.1 |
| 2.5          | 0.292    | -8.2   | 13.58 | 4.776    | 96.7  | 0.106    | -12.2 | 0.166    | -23.6  | 1.2 |
| 3.0          | 0.295    | -20.7  | 13.13 | 4.532    | 82.8  | 0.105    | -13.4 | 0.154    | -32.4  | 1.2 |
| 3.5          | 0.291    | -33.3  | 12.69 | 4.309    | 69.3  | 0.105    | -14.3 | 0.135    | -42    | 1.2 |
| 4.0          | 0.273    | -47.8  | 12.28 | 4.112    | 56    | 0.106    | -14.8 | 0.113    | -54.4  | 1.3 |
| 4.5          | 0.256    | -64.9  | 11.93 | 3.947    | 42.9  | 0.108    | -15   | 0.092    | -73.9  | 1.3 |
| 5.0          | 0.238    | -84.7  | 11.48 | 3.75     | 29.6  | 0.111    | -15.5 | 0.081    | -98.8  | 1.3 |
| 5.5          | 0.23     | -106.8 | 11.07 | 3.578    | 16.8  | 0.117    | -15.9 | 0.084    | -124.6 | 1.3 |
| 6.0          | 0.233    | -128.8 | 10.63 | 3.399    | 3.9   | 0.125    | -17.2 | 0.095    | -148   | 1.3 |
| 6.5          | 0.229    | -149.2 | 10.20 | 3.237    | -8.6  | 0.137    | -19.2 | 0.098    | -170   | 1.3 |
| 7.0          | 0.223    | -171.8 | 9.79  | 3.088    | -21.2 | 0.151    | -22.8 | 0.1      | 162.6  | 1.2 |
| 7.5          | 0.224    | 162    | 9.33  | 2.927    | -34   | 0.164    | -28.1 | 0.112    | 130    | 1.2 |
| 8.0          | 0.241    | 133.6  | 8.81  | 2.757    | -46.8 | 0.177    | -34.4 | 0.143    | 100    | 1.2 |
| 8.5          | 0.272    | 108.9  | 8.19  | 2.566    | -59.2 | 0.187    | -40.9 | 0.188    | 78.8   | 1.2 |
| 9.0          | 0.329    | 88.1   | 7.57  | 2.39     | -71.1 | 0.199    | -47.1 | 0.244    | 64.9   | 1.1 |
| 9.5          | 0.381    | 71.2   | 6.77  | 2.18     | -83.5 | 0.211    | -54.3 | 0.304    | 54.5   | 1.1 |
| 10.0         | 0.444    | 57.5   | 6.07  | 2.012    | -95.2 | 0.22     | -61.8 | 0.362    | 45.7   | 1.0 |

**Notes:**

1. S-parameters are measured on a microstrip line made on 0.025 inch thick alumina carrier. The input reference plane is at the end of the input lead. The output reference plane is at the end of the output lead.

**ADA-4543 Typical Scattering Parameters,  $T_A = 25^\circ\text{C}$ ,  $I_d = 20\text{ mA}$**

| Freq.<br>GHz | S <sub>11</sub> |        |       | S <sub>21</sub> |       |       | S <sub>12</sub> |       | S <sub>22</sub> |     | K |
|--------------|-----------------|--------|-------|-----------------|-------|-------|-----------------|-------|-----------------|-----|---|
|              | Mag.            | Ang.   | dB    | Mag.            | Ang.  | Mag.  | Ang.            | Mag.  | Ang.            |     |   |
| 0.1          | 0.1             | 168    | 16.54 | 6.714           | 175.9 | 0.104 | -0.2            | 0.032 | 168.8           | 1.1 |   |
| 0.5          | 0.122           | 115    | 16.40 | 6.61            | 160.9 | 0.104 | -1.8            | 0.052 | 100.8           | 1.1 |   |
| 0.9          | 0.188           | 73.6   | 16.16 | 6.427           | 146   | 0.105 | -3.5            | 0.096 | 54              | 1.0 |   |
| 1.0          | 0.194           | 67.9   | 16.06 | 6.352           | 142.3 | 0.105 | -4              | 0.104 | 46.9            | 1.0 |   |
| 1.5          | 0.244           | 37.8   | 15.50 | 5.955           | 125   | 0.104 | -6.3            | 0.132 | 21.5            | 1.0 |   |
| 1.9          | 0.266           | 21.1   | 14.99 | 5.614           | 112.1 | 0.104 | -7.9            | 0.145 | 7.7             | 1.1 |   |
| 2.0          | 0.273           | 16.9   | 14.87 | 5.537           | 109   | 0.103 | -8.3            | 0.147 | 5               | 1.1 |   |
| 2.5          | 0.29            | 1.5    | 14.24 | 5.152           | 94.4  | 0.103 | -9.9            | 0.151 | -6.9            | 1.1 |   |
| 3.0          | 0.296           | -11.5  | 13.69 | 4.838           | 80.6  | 0.102 | -11             | 0.142 | -16.6           | 1.2 |   |
| 3.5          | 0.288           | -25.1  | 13.16 | 4.552           | 67.3  | 0.102 | -11.8           | 0.125 | -26.1           | 1.2 |   |
| 4.0          | 0.268           | -39.4  | 12.71 | 4.319           | 54.4  | 0.103 | -12.1           | 0.102 | -38.2           | 1.3 |   |
| 4.5          | 0.248           | -56.2  | 12.31 | 4.125           | 41.5  | 0.106 | -12.2           | 0.077 | -57.8           | 1.3 |   |
| 5.0          | 0.226           | -75.8  | 11.83 | 3.904           | 28.6  | 0.11  | -12.5           | 0.061 | -87.1           | 1.3 |   |
| 5.5          | 0.214           | -98.9  | 11.41 | 3.719           | 16    | 0.117 | -12.9           | 0.062 | -122.1          | 1.3 |   |
| 6.0          | 0.214           | -121.9 | 10.96 | 3.531           | 3.3   | 0.126 | -14.3           | 0.076 | -151.9          | 1.3 |   |
| 6.5          | 0.209           | -143   | 10.52 | 3.357           | -9    | 0.138 | -16.4           | 0.084 | -177.5          | 1.3 |   |
| 7.0          | 0.204           | -166.2 | 10.11 | 3.202           | -21.5 | 0.153 | -20.2           | 0.093 | 152.3           | 1.2 |   |
| 7.5          | 0.202           | 165.3  | 9.64  | 3.035           | -34.2 | 0.167 | -25.7           | 0.115 | 120.1           | 1.2 |   |
| 8.0          | 0.22            | 134.5  | 9.15  | 2.869           | -47.1 | 0.181 | -32.2           | 0.154 | 92.3            | 1.1 |   |
| 8.5          | 0.256           | 109.2  | 8.48  | 2.656           | -59.3 | 0.192 | -39             | 0.206 | 74              | 1.1 |   |
| 9.0          | 0.312           | 88.5   | 7.87  | 2.474           | -71.1 | 0.204 | -45.6           | 0.265 | 61.2            | 1.1 |   |
| 9.5          | 0.368           | 71.2   | 7.11  | 2.266           | -83.4 | 0.217 | -53.1           | 0.327 | 51.2            | 1.1 |   |
| 10.0         | 0.432           | 57.1   | 6.37  | 2.082           | -95.1 | 0.227 | -60.9           | 0.386 | 42.6            | 1.0 |   |

**Notes:**

1. S-parameters are measured on a microstrip line made on 0.025 inch thick alumina carrier. The input reference plane is at the end of the input lead. The output reference plane is at the end of the output lead.

**ADA-4543 Typical Scattering Parameters,  $T_A = 25^\circ\text{C}$ ,  $I_d = 30\text{ mA}$**

| Freq.<br>GHz | $S_{11}$ |        |       | $S_{21}$ |       |       | $S_{12}$ |       | $S_{22}$ |     | K |
|--------------|----------|--------|-------|----------|-------|-------|----------|-------|----------|-----|---|
|              | Mag.     | Ang.   | dB    | Mag.     | Ang.  | Mag.  | Ang.     | Mag.  | Ang.     |     |   |
| 0.1          | 0.17     | 171.3  | 17.29 | 7.32     | 175.8 | 0.096 | 0.1      | 0.105 | 173.1    | 1.1 |   |
| 0.5          | 0.179    | 129.9  | 17.15 | 7.206    | 160.6 | 0.097 | -0.3     | 0.108 | 133.8    | 1.0 |   |
| 0.9          | 0.223    | 89.4   | 16.92 | 7.017    | 145.3 | 0.099 | -1.3     | 0.12  | 87.2     | 1.0 |   |
| 1.0          | 0.226    | 82.7   | 16.82 | 6.931    | 141.5 | 0.099 | -1.7     | 0.123 | 78.5     | 1.0 |   |
| 1.5          | 0.257    | 48.6   | 16.19 | 6.449    | 123.5 | 0.1   | -3.9     | 0.137 | 45.2     | 1.0 |   |
| 1.9          | 0.277    | 30.9   | 15.61 | 6.035    | 110.5 | 0.1   | -5.6     | 0.147 | 27.3     | 1.0 |   |
| 2.0          | 0.283    | 26.4   | 15.48 | 5.941    | 107.4 | 0.1   | -6       | 0.15  | 23.6     | 1.0 |   |
| 2.5          | 0.298    | 9.4    | 14.77 | 5.478    | 92.7  | 0.1   | -7.7     | 0.153 | 8.6      | 1.1 |   |
| 3.0          | 0.299    | -4.6   | 14.14 | 5.095    | 79.1  | 0.1   | -8.9     | 0.145 | -2.7     | 1.1 |   |
| 3.5          | 0.289    | -18.1  | 13.56 | 4.766    | 65.9  | 0.101 | -9.6     | 0.128 | -12.6    | 1.2 |   |
| 4.0          | 0.266    | -32.3  | 13.07 | 4.502    | 53.3  | 0.102 | -9.9     | 0.104 | -24      | 1.2 |   |
| 4.5          | 0.244    | -49    | 12.64 | 4.284    | 40.6  | 0.105 | -9.9     | 0.074 | -41.4    | 1.3 |   |
| 5.0          | 0.22     | -68.7  | 12.14 | 4.048    | 27.9  | 0.109 | -10.2    | 0.051 | -71      | 1.3 |   |
| 5.5          | 0.204    | -91.9  | 11.70 | 3.848    | 15.5  | 0.116 | -10.5    | 0.047 | -116     | 1.3 |   |
| 6.0          | 0.201    | -115.7 | 11.25 | 3.651    | 2.9   | 0.126 | -12      | 0.062 | -154.1   | 1.3 |   |
| 6.5          | 0.196    | -137.6 | 10.80 | 3.468    | -9.3  | 0.139 | -14.3    | 0.075 | 176.7    | 1.2 |   |
| 7.0          | 0.188    | -162.3 | 10.38 | 3.305    | -21.6 | 0.154 | -18.2    | 0.091 | 145.3    | 1.2 |   |
| 7.5          | 0.189    | 167.9  | 9.93  | 3.137    | -34.2 | 0.17  | -23.8    | 0.12  | 114.5    | 1.1 |   |
| 8.0          | 0.205    | 135.4  | 9.43  | 2.962    | -47   | 0.184 | -30.6    | 0.165 | 88.8     | 1.1 |   |
| 8.5          | 0.24     | 109.5  | 8.75  | 2.739    | -59.3 | 0.196 | -37.6    | 0.221 | 71.7     | 1.1 |   |
| 9.0          | 0.303    | 88.3   | 8.17  | 2.561    | -71   | 0.208 | -44.3    | 0.282 | 59.4     | 1.1 |   |
| 9.5          | 0.361    | 70.9   | 7.38  | 2.339    | -83.4 | 0.221 | -52      | 0.345 | 49.6     | 1.0 |   |
| 10.0         | 0.429    | 57.2   | 6.69  | 2.161    | -94.8 | 0.231 | -60      | 0.405 | 40.9     | 1.0 |   |

**Notes:**

1. S-parameters are measured on a microstrip line made on 0.025 inch thick alumina carrier. The input reference plane is at the end of the input lead. The output reference plane is at the end of the output lead.



## Ordering Information

| Part Number   | No. of Devices | Container      |
|---------------|----------------|----------------|
| ADA-4543-TR1  | 3000           | 7" Reel        |
| ADA-4543-TR2  | 10000          | 13" Reel       |
| ADA-4543-BLK  | 100            | antistatic bag |
| ADA-4543-TR1G | 3000           | 7" Reel        |
| ADA-4543-TR2G | 10000          | 13" Reel       |
| ADA-4543-BLKG | 100            | antistatic bag |

Note: For lead-free option, the part number will have the character "G" at the end.

## Package Dimensions Outline 43 SOT-343 (SC70 4-lead)

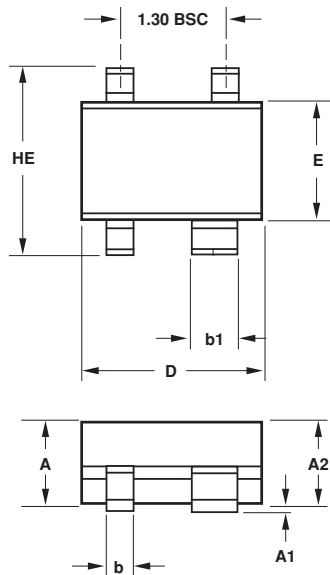

| SYMBOL | DIMENSIONS (mm) |      |
|--------|-----------------|------|
|        | MIN.            | MAX. |
| E      | 1.15            | 1.35 |
| D      | 1.85            | 2.25 |
| HE     | 1.80            | 2.40 |
| A      | 0.80            | 1.10 |
| A2     | 0.80            | 1.00 |
| A1     | 0.00            | 0.10 |
| b      | 0.25            | 0.40 |
| b1     | 0.55            | 0.70 |
| c      | 0.10            | 0.20 |
| L      | 0.10            | 0.46 |

### NOTES:

1. All dimensions are in mm.
2. Dimensions are inclusive of plating.
3. Dimensions are exclusive of mold flash & metal burr.
4. All specifications comply to EIAJ SC70.
5. Die is facing up for mold and facing down for trim/form, ie: reverse trim/form.
6. Package surface to be mirror finish.

## Recommended PCB Pad Layout for Avago's SC70 4L/SOT-343 Products

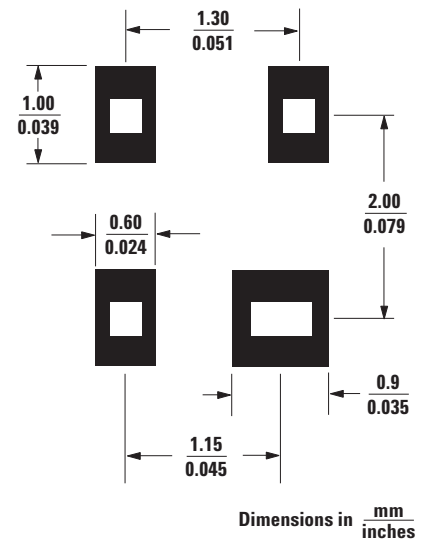

## Device Orientation

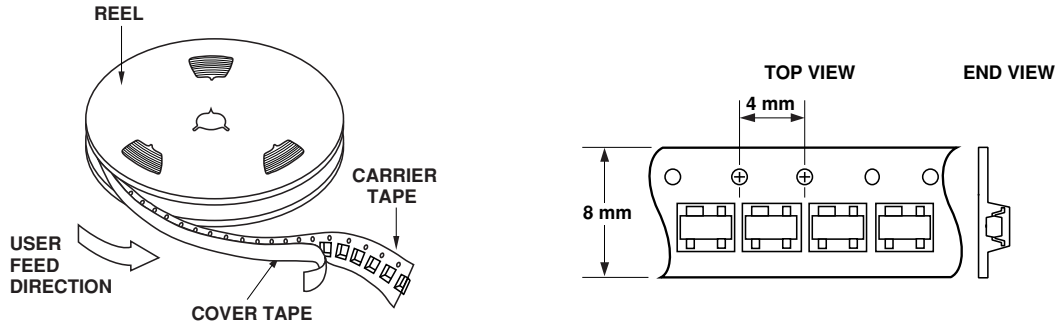

## Tape Dimensions For Outline 4T

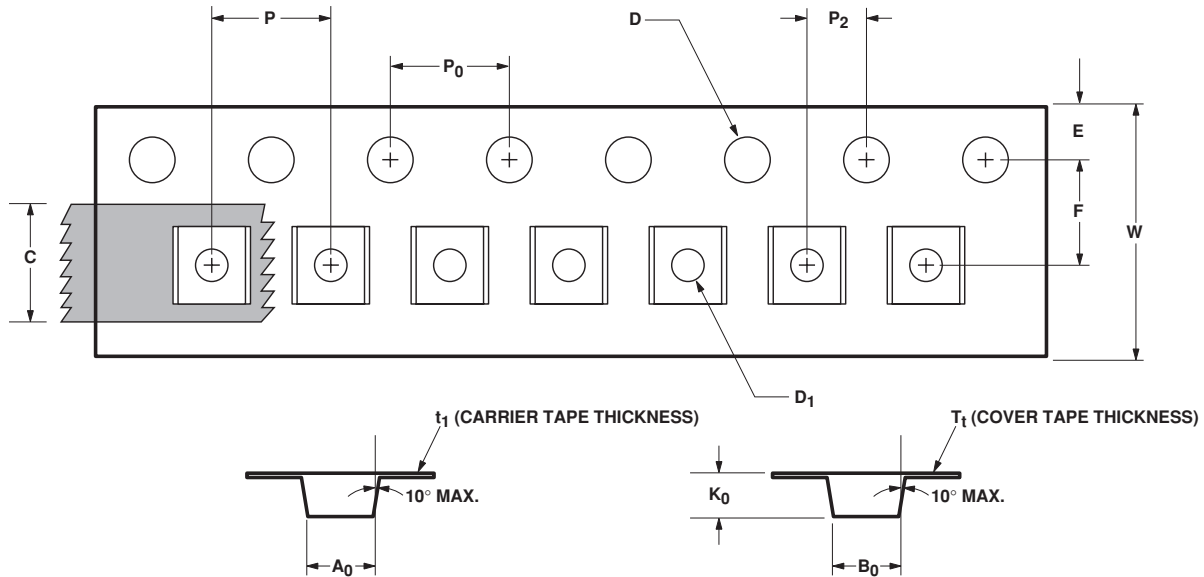

| DESCRIPTION  |  | SYMBOL         | SIZE (mm)          | SIZE (INCHES)   |
|--------------|--|----------------|--------------------|-----------------|
| CAVITY       | LENGTH                                   | A <sub>0</sub> | 2.40 ± 0.10        | 0.094 ± 0.004   |
|              | WIDTH                                    | B <sub>0</sub> | 2.40 ± 0.10        | 0.094 ± 0.004   |
|              | DEPTH                                    | K <sub>0</sub> | 1.20 ± 0.10        | 0.047 ± 0.004   |
|              | PITCH                                    | P              | 4.00 ± 0.10        | 0.157 ± 0.004   |
|              | BOTTOM HOLE DIAMETER                     | D <sub>1</sub> | 1.00 ± 0.25        | 0.039 ± 0.010   |
| PERFORATION  | DIAMETER                                 | D              | 1.50 ± 0.10        | 0.061 ± 0.002   |
|              | PITCH                                    | P <sub>0</sub> | 4.00 ± 0.10        | 0.157 ± 0.004   |
|              | POSITION                                 | E              | 1.75 ± 0.10        | 0.069 ± 0.004   |
| CARRIER TAPE | WIDTH                                    | W              | 8.00 ± 0.30 - 0.10 | 0.315 ± 0.012   |
|              | THICKNESS                                | t <sub>1</sub> | 0.254 ± 0.02       | 0.0100 ± 0.0008 |
| COVER TAPE   | WIDTH                                    | C              | 5.40 ± 0.10        | 0.205 ± 0.004   |
|              | TAPE THICKNESS                           | T <sub>t</sub> | 0.062 ± 0.001      | 0.0025 ± 0.0004 |
| DISTANCE     | CAVITY TO PERFORATION (WIDTH DIRECTION)  | F              | 3.50 ± 0.05        | 0.138 ± 0.002   |
|              | CAVITY TO PERFORATION (LENGTH DIRECTION) | P <sub>2</sub> | 2.00 ± 0.05        | 0.079 ± 0.002   |

For product information and a complete list of distributors, please go to our web site:  
[www.avagotech.com](http://www.avagotech.com)

Avago, Avago Technologies, and the A logo are trademarks of Avago Technologies, Limited in the United States and other countries.

Data subject to change. Copyright © 2006 Avago Technologies, Limited. All rights reserved.  
 Obsoletes 5989-1974EN  
 5989-3752EN April 17, 2006

**AVAGO**  
 TECHNOLOGIES