



Intel[®] 810 Chipset:

**Intel[®] 82810/82810-DC100 Graphics
and Memory Controller Hub (GMCH)**

Datasheet

April 1999

Order Number: 290656-001



Information in this document is provided in connection with Intel products. No license, express or implied, by estoppel or otherwise, to any intellectual property rights is granted by this document. Except as provided in Intel's Terms and Conditions of Sale for such products, Intel assumes no liability whatsoever, and Intel disclaims any express or implied warranty, relating to sale and/or use of Intel products including liability or warranties relating to fitness for a particular purpose, merchantability, or infringement of any patent, copyright or other intellectual property right. Intel products are not intended for use in medical, life saving, or life sustaining applications.

Intel may make changes to specifications and product descriptions at any time, without notice.

Designers must not rely on the absence or characteristics of any features or instructions marked "reserved" or "undefined." Intel reserves these for future definition and shall have no responsibility whatsoever for conflicts or incompatibilities arising from future changes to them.

The Intel® 810 and Intel® 810-DC100 may contain design defects or errors known as errata which may cause the product to deviate from published specifications. Current characterized errata are available on request.

Contact your local Intel sales office or your distributor to obtain the latest specifications and before placing your product order.

I²C is a 2-wire communications bus/protocol developed by Philips. SMBus is a subset of the I²C bus/protocol and was developed by Intel. Implementations of the I²C bus/protocol may require licenses from various entities, including Philips Electronics N.V. and North American Philips Corporation.

Alert on LAN is a result of the Intel-IBM Advanced Manageability Alliance and a trademark of IBM

Copies of documents which have an ordering number and are referenced in this document, or other Intel literature, may be obtained from:

Intel Corporation

or call 1-800-548-4725

*Third-party brands and names are the property of their respective owners.

Copyright © Intel Corporation 1998, 1999

Contents

1.	Overview.....	11
1.1.	The Intel® 810 Chipset System	11
1.2.	GMCH Overview	14
1.3.	Host Interface	15
1.4.	System Memory Interface.....	15
1.5.	Display Cache Interface (82810-DC100 Only).....	15
1.6.	Hub Interface	16
1.7.	GMCH Graphics Support.....	16
1.7.1.	Display, Digital Video Out, and LCD/Flat Panel	16
1.8.	System Clocking	17
1.9.	References	17
2.	Signal Description.....	18
2.1.	Host Interface Signals.....	19
2.2.	System Memory Interface Signals	20
2.3.	Display Cache Interface Signals (82810-DC100 only).....	21
2.4.	Hub Interface Signals	21
2.5.	Display Interface Signals	22
2.6.	Digital Video Output Signals/TV-Out Pins	23
2.7.	Power Signals	24
2.8.	Clock Signals	24
2.9.	Miscellaneous Interface Signals	25
2.10.	Power-Up/Reset Strap Options (82810)	25
2.11.	Power-Up/Reset Strap Options (82810-DC100).....	25
3.	Configuration Registers.....	26
3.1.	Register Nomenclature and Access Attributes	26
3.2.	PCI Configuration Space Access.....	27
3.2.1.	PCI Bus Configuration Mechanism	27
3.2.2.	Logical PCI Bus #0 Configuration Mechanism.....	28
3.2.3.	Primary PCI (PCI0) and Downstream Configuration Mechanism	28
3.2.4.	Internal Graphics Device Configuration Mechanism.....	28
3.2.5.	GMCH Register Introduction.....	28
3.3.	I/O Mapped Registers.....	29
3.3.1.	CONFIG_ADDRESS—Configuration Address Register	29
3.3.2.	CONFIG_DATA—Configuration Data Register	30
3.4.	Host-Hub Interface Bridge/DRAM Controller Device Registers (Device 0)	30
3.4.1.	VID—Vendor Identification Register (Device 0)	32
3.4.2.	DID—Device Identification Register (Device 0)	32
3.4.3.	PCICMD—PCI Command Register (Device 0).....	32
3.4.4.	PCISTS—PCI Status Register (Device 0)	34
3.4.5.	RID—Revision Identification Register (Device 0).....	35
3.4.6.	SUBC—Sub-Class Code Register (Device 0)	35
3.4.7.	BCC—Base Class Code Register (Device 0)	35
3.4.8.	MLT—Master Latency Timer Register (Device 0).....	36
3.4.9.	HDR—Header Type Register (Device 0)	36

3.4.10.	SVID—Subsystem Vendor Identification Register (Device 0)	36
3.4.11.	SID—Subsystem Identification Register (Device 0)	37
3.4.12.	CAPPTR—Capabilities Pointer (Device 0)	37
3.4.13.	GMCHCFG—GMCH Configuration Register (Device 0)	38
3.4.14.	PAMR—Programmable Attributes Register (Device 0)	39
3.4.15.	DRP—DRAM Row Population Register (Device 0)	40
3.4.16.	DRAMT—DRAM Timing Register (Device 0)	42
3.4.17.	FCHC—Fixed DRAM Hole Control Register (Device 0)	43
3.4.18.	SMRAM—System Management RAM Control Register (Device 0)	44
3.4.19.	MISCC—Miscellaneous Control Register (Device 0)	46
3.4.20.	MISCC2—Miscellaneous Control 2 Register (Device 0)	47
3.4.21.	BUFF_SC—System Memory Buffer Strength Control Register (Device 0)	48
3.5.	Graphics Device Registers – (Device 1)	50
3.5.1.	VID—Vendor Identification Register (Device 1)	51
3.5.2.	DID—Device Identification Register (Device 1)	51
3.5.3.	PCICMD—PCI Command Register (Device 1)	52
3.5.4.	PCISTS—PCI Status Register (Device 1)	53
3.5.5.	RID—Revision Identification Register (Device 1)	54
3.5.6.	PI—Programming Interface Register (Device 1)	54
3.5.7.	SUBC1—Sub-Class Code Register (Device 1)	54
3.5.8.	BCC1—Base Class Code Register (Device 1)	55
3.5.9.	CLS—Cache Line Size Register (Device 1)	55
3.5.10.	MLT—Master Latency Timer Register (Device 1)	55
3.5.11.	HDR—Header Type Register (Device 1)	56
3.5.12.	BIST—Built In Self Test (BIST) Register (Device 1)	56
3.5.13.	GMADR—Graphics Memory Range Address Register (Device 1)	57
3.5.14.	MMADR—Memory Mapped Range Address Register (Device 1)	58
3.5.15.	SVID—Subsystem Vendor Identification Register (Device 1)	58
3.5.16.	SID—Subsystem Identification Register (Device 1)	59
3.5.17.	ROMADR—Video BIOS ROM Base Address Registers (Device 1)	59
3.5.18.	CAPPOINT—Capabilities Pointer Register (Device 1)	59
3.5.19.	INTRLINE—Interrupt Line Register (Device 1)	60
3.5.20.	INTRPIN—Interrupt Pin Register (Device 1)	60
3.5.21.	MINGNT—Minimum Grant Register (Device 1)	60
3.5.22.	MAXLAT—Maximum Latency Register (Device 1)	60
3.5.23.	PM_CAPID—Power Management Capabilities ID Register (Device 1)	61
3.5.24.	PM_CAP—Power Management Capabilities Register (Device 1)	61
3.5.25.	PM_CS—Power Management Control/Status Register (Device 1)	62
3.6.	Display Cache Interface (82810-DC100 Only)	63
3.6.1.	DRT—DRAM Row Type	63
3.6.2.	DRAMCL—DRAM Control Low	64
3.6.3.	DRAMCH—DRAM Control High	65
3.7.	Display Cache Detect and Diagnostic Registers (82810-DC100 Only)	66
3.7.1.	GRX—GRX Graphics Controller Index Register	66
3.7.2.	MSP—Miscellaneous Output	67
3.7.3.	GR06—Miscellaneous Register	68
3.7.4.	GR10—Address Mapping	69
3.7.5.	GR11—Page Selector	69

4.	Functional Description.....	70
4.1.	System Address Map.....	70
4.1.1.	Memory Address Ranges.....	71
4.1.1.1.	Compatibility Area.....	72
4.1.1.2.	Extended Memory Area.....	74
4.1.1.3.	System Management Mode (SMM) Memory Range.....	75
4.1.2.	Memory Shadowing.....	76
4.1.3.	I/O Address Space.....	76
4.1.4.	GMCH Decode Rules and Cross-Bridge Address Mapping.....	77
4.2.	Host Interface.....	77
4.2.1.	Host Bus Device Support.....	77
4.2.2.	Special Cycles.....	80
4.3.	System Memory DRAM Interface.....	81
4.3.1.	DRAM Organization and Configuration.....	81
4.3.1.1.	Configuration Mechanism For DIMMs.....	82
4.3.1.2.	DRAM Register Programming.....	82
4.3.2.	DRAM Address Translation and Decoding.....	83
4.3.3.	DRAM Array Connectivity.....	85
4.3.4.	SDRAMT Register Programming.....	85
4.3.5.	SDRAM Paging Policy.....	86
4.4.	Intel® Dynamic Video Memory Technology (D.V.M.).....	86
4.5.	Display Cache Interface (82810-DC100 Only).....	86
4.5.1.	Supported DRAM Types.....	87
4.5.2.	Memory Configurations.....	87
4.5.3.	Address Translation.....	88
4.5.4.	Display Cache Interface Timing.....	88
4.6.	Internal Graphics Device.....	89
4.6.1.	3D/2D Instruction Processing.....	89
4.6.2.	3D Engine.....	90
4.6.3.	Buffers.....	90
4.6.4.	Setup.....	92
4.6.5.	Texturing.....	92
4.6.6.	2D Operation.....	94
4.6.7.	Fixed Blitter (BLT) and Stretch Blitter (STRBLT) Engines.....	94
4.6.7.1.	Fixed BLT Engine.....	95
4.6.7.2.	Arithmetic Stretch BLT Engine.....	95
4.6.8.	Hardware Motion Compensation.....	95
4.6.9.	Hardware Cursor.....	96
4.6.10.	Overlay Engine.....	96
4.6.11.	Display.....	96
4.6.12.	Flat Panel Interface / 1.8V TV-Out Interface.....	98
4.6.13.	DDC (Display Data Channel).....	99
4.7.	System Reset for the GMCH.....	100
4.8.	System Clock Description.....	100
4.9.	Power Management.....	100
4.9.1.	Specifications Supported.....	100
5.	Pinout and Package Information.....	101
5.1.	82810 and 82810-DC100 GMCH Pinout.....	101
5.2.	Package Dimensions.....	107

6.	Testability.....	109
6.1.	XOR TREE Testability Algorithm Example	110
6.1.1.	Test Pattern Consideration for XOR Chain 7	110
6.2.	XOR Tree Initialization	111
6.2.1.	Chain [1:2, 4:7] Initialization.....	111
6.2.2.	Chain 3 Initialization.....	111
6.3.	XOR Chain Pin Assignments	112

Figures

Figure 1. Intel® 810 Chipset System Block Diagram With Intel 82810 GMCH and Either ICH or ICH0	12
Figure 2. Intel® 810 Chipset System Block Diagram With Intel 82810-DC100 GMCH and ICH.....	13
Figure 3. GMCH Block Diagram.....	14
Figure 4. System Memory Address Map.....	71
Figure 5. Detailed Memory System Address Map.....	72
Figure 6. DRAM Array Sockets.....	85
Figure 7. GMCH Display Cache Interface to 4MB.....	87
Figure 8. 3D/2D Pipeline Preprocessor.....	89
Figure 9. Data Flow for the 3D Pipeline.....	91
Figure 10. GMCH Pinout (Top View-Left Side).....	102
Figure 11. GMCH Pinout (Top View-Right Side).....	103
Figure 12. GMCH Package Dimensions (421 BGA) – Top and Side Views	107
Figure 13. GMCH Package Dimensions (421 BGA) – Top and Side Views	108
Figure 14. XOR Tree Implementation	109

Tables

Table 1. Power-Up Options (82810).....	25
Table 2. Power-Up Options (82810-DC100).....	25
Table 3. GMCH PCI Configuration Space (Device 0).....	31
Table 4. Programming DRAM Row Population Register Fields.....	41
Table 5. GMCH Configuration Space (Device 1).....	50
Table 6. Memory Segments and their Attributes.....	73
Table 7. Summay of Transactions Supported By GMCH.....	78
Table 8. Host Responses Supported by the GMCH.....	79
Table 9. Special Cycles.....	80
Table 10. Sample Of Possible Mix And Match Options For 4 Row/2 DIMM Configurations.....	82
Table 11. Data Bytes on DIMM Used for Programming DRAM Registers.....	83
Table 12. GMCH DRAM Address Mux Function.....	84
Table 13. Programmable SDRAM Timing Parameters.....	85
Table 14. Memory Size for each configuration :.....	87
Table 15. Partial List of Display Modes Supported.....	97
Table 16. Partial List of Flat Panel Modes Supported.....	98
Table 17. Partial List of TV-Out Modes Supported.....	99
Table 18. Alphabetical Pin Assignment.....	104
Table 19. GMCH Package Dimensions (421 BGA).....	108
Table 20. XOR Test Pattern Example.....	110
Table 21. XOR Chain 1.....	112
Table 22. XOR Chain 2.....	112
Table 23. XOR Chain 3.....	113
Table 24. XOR Chain 4.....	114
Table 25. XOR Chain 5.....	115
Table 26. XOR Chain 6.....	116
Table 27. XOR Chain 7.....	117



Revision History

Rev.	Description	Date
-001	Initial Release	April 1999

Intel® 82810 and Intel® 82810-DC100

Product Features

- Processor/Host Bus Support
 - Optimized for the Intel® Pentium II processor, Intel® Pentium III processor, and Intel® Celeron™ processor
 - Supports processor 370-Pin Socket and SC242 connectors
 - Supports 32-Bit System Bus Addressing
 - 4 deep in-order queue; 4 or 1 deep request queue
 - Supports Uni-processor systems only
 - In-order and Dynamic Deferred Transaction Support
 - 66/100MHz System Bus Frequency
 - GTL+ I/O Buffer
- Integrated DRAM Controller
 - 8 MB to 256 MB using 16Mb/64Mb technology (512 MB using 128Mb technology)
 - Supports up to 2 double sided DIMM modules
 - 64-bit data interface
 - 100MHz system memory bus frequency
 - Support for Asymmetrical DRAM addressing only
 - Support for x8, x16 and x32 DRAM device width
 - Refresh Mechanism: CBR ONLY supported
 - Enhanced Open page Arbitration SDRAM paging scheme
 - Suspend to RAM support
- Integrated Graphics Controller
 - 3D Hyper Pipelined Architecture
 - -Parallel Data Processing (PDP)
 - -Precise Pixel Interpolation (PPI)
 - Full 2D H/W Acceleration
 - Motion Video Acceleration
- 3D Graphics Visual Enhancements
 - Flat & Gouraud Shading
 - Mip Maps with Bilinear and Anisotropic Filtering
 - Fogging Atmospheric Effects
 - Z Buffering
 - 3D Pipe 2D Clipping
 - Backface Culling
- 3D Graphics Texturing Enhancements
 - Per Pixel Perspective Correction Texture Mapping
 - Texture Compositing
 - Texture Color Keying/Chroma Keying
- Digital Video Output
 - 85MHz Flat Panel Monitor Interface Or Digital Video Output for use with a external TV encoder
- Display
 - Integrated 24-bit 230MHz RAMDAC
 - Gamma Corrected Video
 - DDC2B Compliant
- 2D Graphics
 - Up to 1600x1200 in 8-bit Color at 85 Hz Refresh
 - Hardware Accelerated Functions
 - 3 Operand Raster BitBLTs
 - 64x64x3 Color Transparent Cursor
- Arithmetic Stretch Blitter Video
 - H/W Motion Compensation Assistance for S/W MPEG2 Decode
 - Software DVD at 30fps
 - Digital Video Out Port
 - NTSC and PAL TV Out Support
 - H/W Overlay Engine with Bilinear Filtering
 - Independent gamma correction, saturation, brightness & contrast for overlay
- Integrated Graphics Memory Controller
 - Intel® D.V.M. Technology
- Display Cache Interface (82810-DC100 Only)
 - 32-bit data interface
 - 100 MHz SDRAM interface
 - Support for 1Mx16, (4 MB Only)
- Arbitration Scheme and Concurrency
 - Centralized Arbitration Model for Optimum Concurrency Support
 - Concurrent operations of CPU and System busses supported via dedicated arbitration and data buffering
- Data Buffering
 - Distributed Data Buffering Model for optimum concurrency
 - DRAM Write Buffer with read-around-write capability
 - Dedicated CPU-DRAM, hub interface-DRAM and Graphics-DRAM Read Buffers
- Power Management Functions
 - SMRAM space remapping to A0000h (128 KB)
 - Optional Extended SMRAM space above 256 MB, additional 512K/1MB TSEG from Top of Memory, cacheable
 - Stop Clock Grant and Halt special cycle translation from the host to the hub interface
 - ACPI Compliant power management
 - APIC Buffer Management
 - SMI, SCI, and SERR error indication
- Supporting I/O Bridge
 - 241 Pin BGA I/O Controller Hub (ICH0/ICH)
- Packaging/Power
 - 421 BGA
 - 1.8V core with 3.3V CMOS I/O

GMCH Simplified Block Diagram

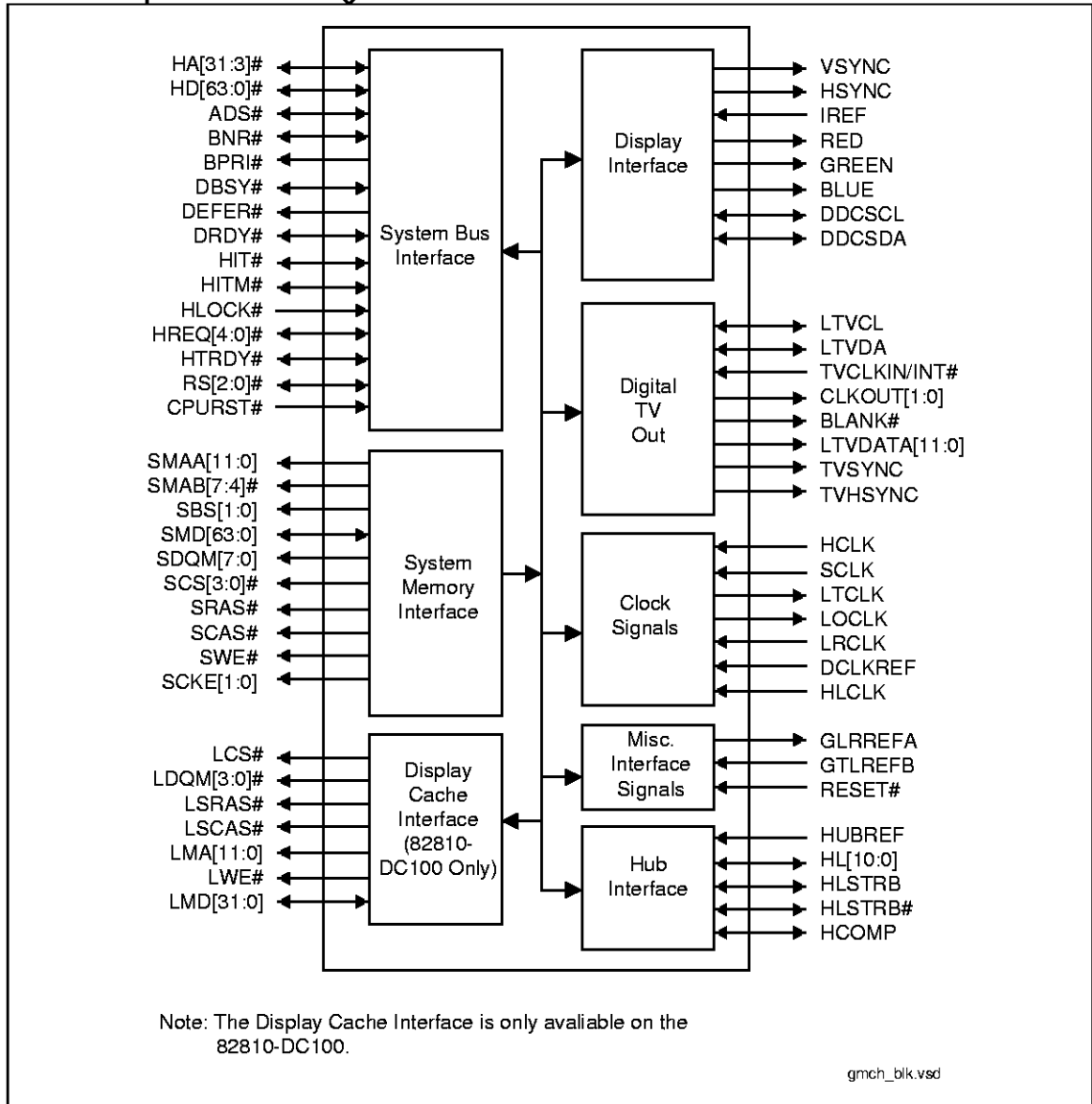

1. Overview

The Intel® 810 Chipset is a high-integration chipset designed for the basic graphics/multimedia PC platform. The chipset consists of a Graphics and Memory Controller Hub (GMCH) Host Bridge and an I/O Controller Hub (ICH/ICH0) Bridge for the I/O subsystem. The GMCH integrates a system memory DRAM controller that supports a 64-bit 100 MHz DRAM array. The DRAM controller is optimized for maximum efficiency.

There are two versions of the GMCH (82810 and 82810-DC100). These two versions are pin compatible. The difference between the two versions is that the 82810DC-100 integrates a Display Cache DRAM controller that supports a 4 MB, 32-bit 100 MHz DRAM array for enhanced 2D and 3D performance.

This document describes both versions of the GMCH (82810 and 82810-DC100). An overview of the Intel® 810 chipset is provided in the next section.

Note: In this document the term “GMCH” refers to both the 82810 and 82810-DC100, unless otherwise specified.

The Intel® 810 and Intel® 810-DC100 may contain design defects or errors known as errata which may cause the product to deviate from published specifications. Current characterized errata are available on request.

1.1. The Intel® 810 Chipset System

The Intel® 810 Chipset uses a hub architecture with the GMCH as the host bridge hub and the 82801xx I/O Controller Hub (ICH) as the I/O hub. The ICH is a highly integrated multifunctional I/O Controller Hub that provides the interface to the PCI Bus and integrates many of the functions needed in today's PC platforms. The GMCH and ICH communicate over a dedicated hub interface. Like the GMCH, there are two versions of the ICH (82801AA: ICH and 82801AB: ICH0). This provides added flexibility in designing cost-effective system solutions. These devices are pin compatible and are in 241-pin packages. The GMCH devices are designed to work with either ICH or ICH0.

82801AA (ICH) / 82801AB (ICH0) functions and capabilities include:

- PCI Rev 2.2 compliant with support for 33 MHz PCI operations
- ICH0 Supports up to 4 Req/Gnt pairs (PCI Slots); ICH supports up to 6 Req/Gnt pairs (PCI Slots)
- Power Management Logic Support
- Enhanced DMA Controller, Interrupt Controller & Timer Functions
- Integrated IDE controller; ICH0 supports Ultra ATA/33; ICH also supports Ultra ATA/66
- USB host interface with support for 2 USB ports
- System Management Bus (SMBus) compatible with most I²C devices
- AC'97 2.1 Compliant Link for Audio and Telephony CODECs
- Low Pin Count (LPC) interface
- Firmware Hub (FWH) interface support
- Alert On LAN* (82801AA ICH only)

Figure 1 and Figure 2 show block diagrams of typical platforms based on the Intel® 810 Chipset. The GMCH supports processor bus frequencies of 66/100 MHz. Figure 1 shows a system without a display cache. It uses the Intel 82810 GMCH and either the ICH (82801AA) or ICH0 (82801AB). Both ICH0 and ICH provide extensive I/O support. The ICH provides additional support for 6 PCI bus Req/Gnt pairs (instead of 4 for the ICH0), increased IDE capability from Ultra ATA/33 to Ultra ATA/66, and Alert On LAN*. Figure 2 shows a system based on the 82810-DC100 GMCH that includes a display cache.

Figure 1. Intel® 810 Chipset System Block Diagram With Intel 82810 GMCH and Either ICH or ICH0

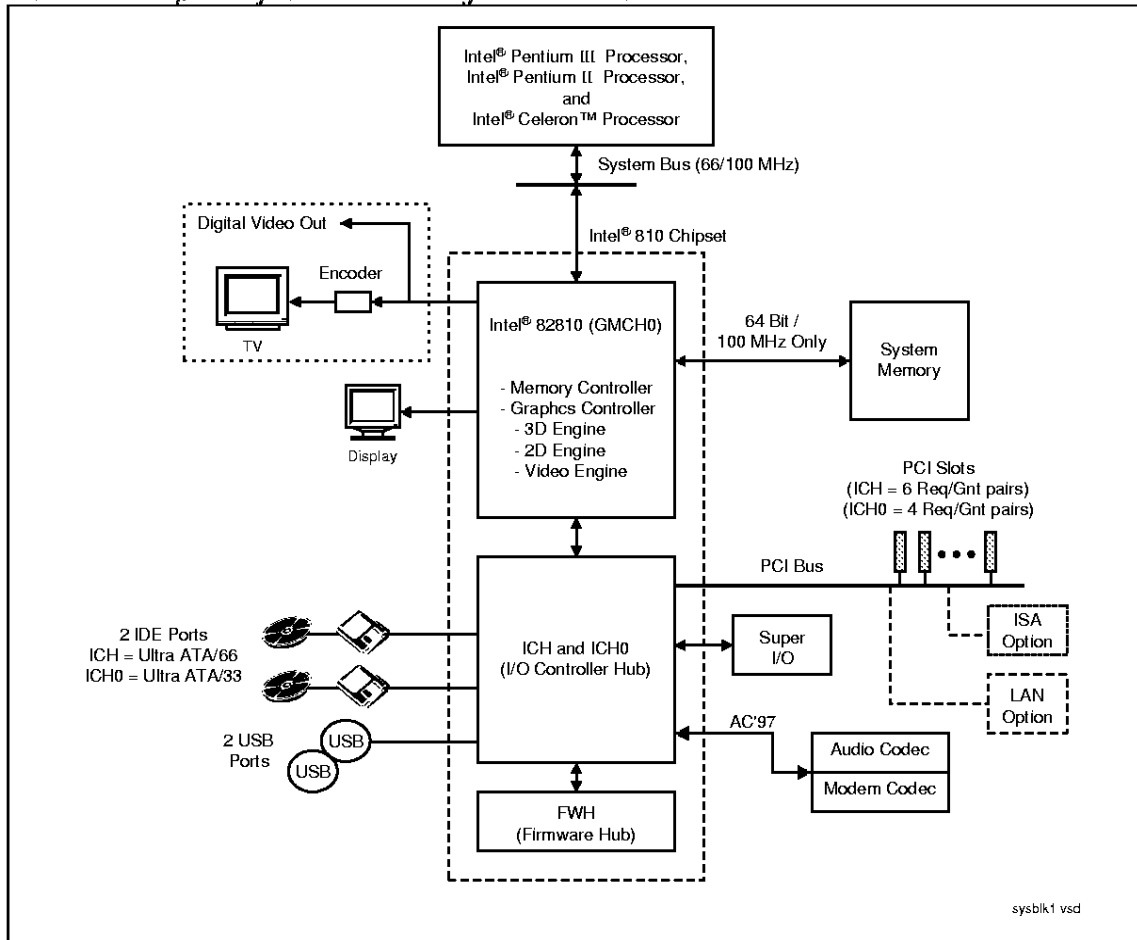
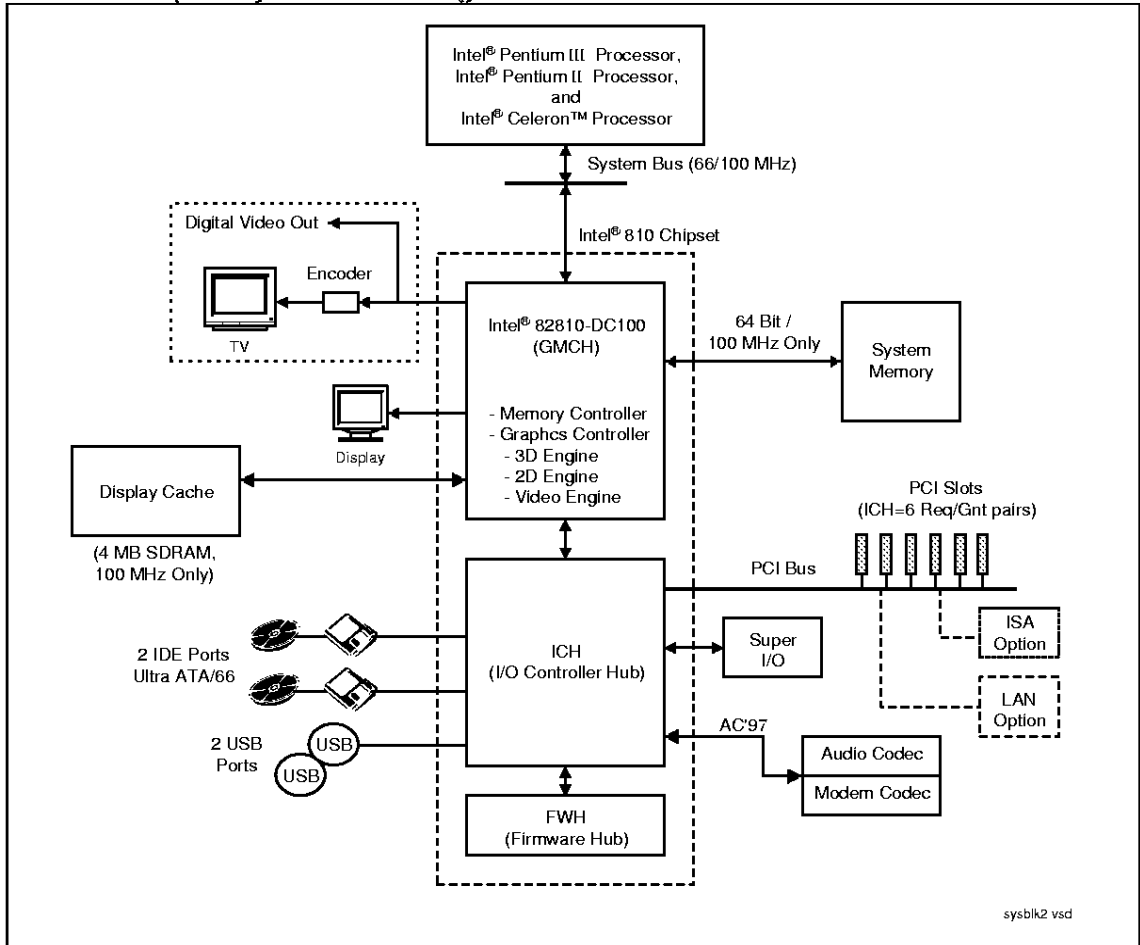

Figure 2. Intel® 810 Chipset System Block Diagram With Intel 82810-DC100 GMCH and ICH



1.2. GMCH Overview

Figure 3 is a block diagram of the GMCH illustrating the various interfaces and integrated components of the GMCH chip. The GMCH functions and capabilities include:

- Support for a single processor configuration
- 64-bit GTL+ based System Bus Interface at 66 MHz/100 MHz
- 32-bit Host Address Support
- 64-bit System Memory Interface with optimized support for SDRAM at 100 MHz
- Integrated 2D & 3D Graphics Engines
- Integrated H/W Motion Compensation Engine
- Integrated 230 MHz DAC
- Integrated Digital Video Out Port
- 4 MB Display Cache (82810-DC100 only)

Figure 3. GMCH Block Diagram

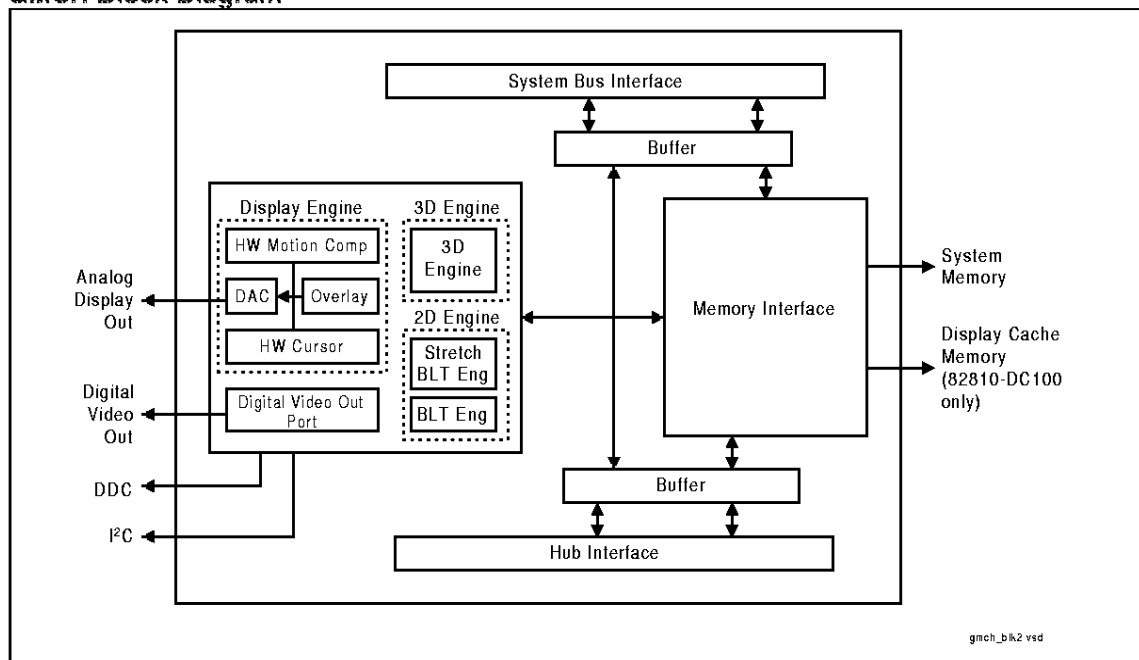

1.3. Host Interface

The host interface of the GMCH is optimized to support the Intel® Pentium III processor, Intel® Pentium II processor, and Intel® Celeron™ processor. The GMCH implements the host address, control, and data bus interfaces within a single device. The GMCH supports a 4-deep in-order queue (i.e., supports pipelining of up to 4 outstanding transaction requests on the host bus). Host bus addresses are decoded by the GMCH for accesses to system memory, PCI memory and PCI I/O (via hub interface), PCI configuration space and Graphics memory. The GMCH takes advantage of the pipelined addressing capability of the processor to improve the overall system performance.

The GMCH supports the 370-pin socket and SC242 processor connectors.

- **370-pin socket (PGA370).** The zero insertion force (ZIF) socket that a processor in the PPGA package will use to interface with a system board.
- **SC242**—242-contact slot connector. A processor in a Single-Edge Processor Package (SEPP) or Single-Edge Contact Cartidge (SECC and SECC2) use this connector to interface with a system board.

1.4. System Memory Interface

The GMCH integrates a system memory DRAM controller that supports a 64-bit 100 MHz DRAM array. The DRAM type supported is industry standard Synchronous DRAM (SDRAM). The DRAM controller interface is fully configurable through a set of control registers. Complete descriptions of these registers are given in the Configuration Register Description Section.

The GMCH supports industry standard 64-bit wide DIMM modules with SDRAM devices. The twelve multiplexed address lines, SMAA[11:0], along with the two bank select lines, SBS[1:0], allow the GMCH to support 2M, 4M, 8M, and 16M x64 DIMMs. Only asymmetric addressing is supported. The GMCH has four SCS# lines, enabling the support of up to four 64-bit rows of DRAM. The GMCH targets SDRAM with CL2 and CL3 and supports both single and double-sided DIMMs. Additionally, the GMCH also provides a seven deep refresh queue. The GMCH can be configured to keep multiple pages open within the memory array, pages can be kept open in any one row of memory.

SCKE[1:0] is used in configurations requiring powerdown mode for the SDRAM.

1.5. Display Cache Interface (82810-DC100 Only)

The 82810-DC100 GMCH supports a Display Cache DRAM controller with a 32-bit 100 MHz DRAM array. The DRAM type supported is industry standard Synchronous DRAM (SDRAM) like that of the system memory. The local memory DRAM controller interface is fully configurable through a set of control registers. Complete descriptions of these registers are given in the *Register Description* Section.

1.6. Hub Interface

The hub interface is a private interconnect between the GMCH and the ICH.

1.7. GMCH Graphics Support

The Graphics and Memory Controller Hub (GMCH) includes a highly integrated graphics accelerator. Its architecture consists of dedicated multi-media engines executing in parallel to deliver high performance 3D, 2D and motion compensation video capabilities. The 3D and 2D engines are managed by a 3D/2D pipeline preprocessor allowing a sustained flow of graphics data to be rendered and displayed. The deeply pipelined 3D accelerator engine provides 3D graphics quality and performance via per-pixel 3D rendering and parallel data paths which allow each pipeline stage to simultaneously operate on different primitives or portions of the same primitive. The GMCH graphics accelerator engine supports perspective-correct texture mapping, bilinear and anisotropic Mip-Mapping, Gouraud shading, alpha-blending, fogging and Z-buffering. A rich set of 3D instructions permit these features to be independently enabled or disabled.

For the 82810-DC100, a Display Cache (DC) can be used for Z-buffers (Textures and display buffer are located in system memory). If the display cache is not used, the Z-buffer is located in system memory.

The GMCH integrated graphics accelerator's 2D capabilities include BLT and arithmetic STRBLT engines, a hardware cursor and an extensive set of 2D registers and instructions. The high performance 64-bit BitBLT engine provides hardware acceleration for many common Windows operations.

In addition to its 2D/3D capabilities, the GMCH integrated graphics accelerator also supports full MPEG-2 motion compensation for software-assisted DVD video playback, a VESA DDC2B compliant display interface and a digital video out port which may support (via an external video encoder) NTSC and PAL broadcast standards.

1.7.1. Display, Digital Video Out, and LCD/Flat Panel

The GMCH provides interfaces to a standard progressive scan monitor, TV-Out device, and LCD/Flat Panel transmitter.

- The GMCH directly drives a standard progressive scan monitor up to a resolution of 1600x1200.
- The GMCH provides a Digital Video Out interface to connect an external device to drive an autodetection of 1024x768 non-scalar DDP digital Flat Panel with appropriate EDID 1.x data. The interface has 1.8V signaling to allow it to operate at higher frequencies. This interface can also connect to a 1.8V TV-Out encoder.

1.8. System Clocking

The GMCH has a new type of clocking architecture. It has integrated SDRAM buffers that always run at 100 MHz, regardless of system bus frequency. The system bus frequency is selectable between 66 MHz and 100 MHz. The GMCH uses a copy of the USB clock as the DOT Clock input for the graphics pixel clock PLL.

1.9. References

- *Intel® 810 Chipset Design Guide*. Contact your field sales representative.
- PC '99: Contact www.microsoft.com/hwdev
- GTL+ I/O Specification: Contained in the *Pentium® II Processor Databook*
- *PCI Local bus Specification 2.2*: Contact www.pcisig.com
- *Intel® 82801AA (ICH) and Intel® 82801AB (ICH0) I/O Controller Hub Datasheet*
- *Intel® 810 Chipset OrCAD Schematics Documentation*

2. Signal Description

This section provides a detailed description of the GMCH signals. The signals are arranged in functional groups according to their associated interface. The states of all of the signals during reset are provided in the System Reset section.

The “#” symbol at the end of a signal name indicates that the active, or asserted state occurs when the signal is at a low voltage level. When “#” is not present after the signal name the signal is asserted when at the high voltage level.

The following notations are used to describe the signal type:

I	Input pin
O	Output pin
I/OD	Input / Open Drain Output pin. This pin requires a pullup to the VCC of the processor core
I/O	Bi-directional Input/Output pin

The signal description also includes the type of buffer used for the particular signal:

GTL+	Open Drain GTL+ interface signal. Refer to the GTL+ I/O Specification for complete details
CMOS	The CMOS buffers are Low Voltage TTL compatible signals. These are 3.3V only.
LVTTTL	Low Voltage TTL compatible signals. There are 3.3V only.
1.8V	1.8V signals for the digital video interface
Analog	Analog CRT Signals

Note that the CPU address and data bus signals (Host Interface) are logically inverted signals (i.e., the actual values are inverted of what appears on the CPU bus). This must be taken into account and the addresses and data bus signals must be inverted inside the GMCH. All CPU control signals follow normal convention. A 0 indicates an active level (low voltage) if the signal is followed by # symbol and a 1 indicates an active level (high voltage) if the signal has no # suffix.

2.1. Host Interface Signals

Signal Name	Type	Description
CPURST#	O GTL+	CPU Reset. The GMCH asserts CPURST# while RESET# (PCIRST# from ICH) is asserted and for approximately 1ms after RESET# is deasserted. The GMCH also pulses CPURST# for approximately 1ms when requested via a hub interface special cycle. The CPURST# allows the CPU to begin execution in a known state.
HA[31:3]#	I/O GTL+	Host Address Bus: HA[31:3]# connect to the CPU address bus. During CPU cycles, HA[31:3]# are inputs. The GMCH drives HA[31:3]# during snoop cycles on behalf of Primary PCI. Note that the address bus is inverted on the CPU bus.
HD[63:0]#	I/O GTL+	Host Data: These signals are connected to the CPU data bus. Note that the data signals are inverted on the CPU bus.
ADS#	I/O GTL+	Address Strobe: The CPU bus owner asserts ADS# to indicate the first of two cycles of a <i>request phase</i> .
BNR#	I/O GTL+	Block Next Request: Used to block the current request bus owner from issuing a new request. This signal is used to dynamically control the CPU bus pipeline depth.
BPRI#	O GTL+	Priority Agent Bus Request: The GMCH is the only Priority Agent on the CPU bus. It asserts this signal to obtain the ownership of the address bus. This signal has priority over symmetric bus requests and will cause the current symmetric owner to stop issuing new transactions unless the HLOCK# signal was asserted.
DBSY#	I/O GTL+	Data Bus Busy: Used by the data bus owner to hold the data bus for transfers requiring more than one cycle.
DEFER#	O GTL+	Defer: The GMCH will generate a deferred response as defined by the rules of the GMCH dynamic defer policy. The GMCH will also use the DEFER# signal to indicate a CPU retry response.
DRDY#	I/O GTL+	Data Ready: Asserted for each cycle that data is transferred.
HIT#	I/O GTL+	Hit: Indicates that a caching agent holds an unmodified version of the requested line. Also driven in conjunction with HITM# by the target to extend the snoop window.
HITM#	I/O GTL+	Hit Modified: Indicates that a caching agent holds a modified version of the requested line and that this agent assumes responsibility for providing the line. HITM# is also driven in conjunction with HIT# to extend the snoop window.
HLOCK#	I GTL+	Host Lock: All CPU bus cycles sampled with the assertion of HLOCK# and ADS#, until the negation of HLOCK# must be atomic (i.e., no hub interface or GMCH graphics snooper access to DRAM is allowed when HLOCK# is asserted by the CPU).
HREQ[4:0]#	I/O GTL+	Host Request Command: Asserted during both clocks of request phase. In the first clock, the signals define the transaction type to a level of detail that is sufficient to begin a snoop request. In the second clock, the signals carry additional information to define the complete transaction type. The transactions supported by the GMCH are defined in the Host Interface section of this document.
HTRDY#	I/O GTL+	Host Target Ready: Indicates that the target of the CPU transaction is able to enter the data transfer phase.

Signal Name	Type	Description																		
RS[2:0]#	I/O GTL+	<p>Response Signals: Indicates type of response as shown below:</p> <table border="1"> <thead> <tr> <th>RS[2:0]</th> <th>Response type</th> </tr> </thead> <tbody> <tr> <td>000</td> <td>Idle state</td> </tr> <tr> <td>001</td> <td>Retry response</td> </tr> <tr> <td>010</td> <td>Deferred response</td> </tr> <tr> <td>011</td> <td>Reserved (not driven by the GMCH)</td> </tr> <tr> <td>100</td> <td>Hard Failure (not driven by the GMCH)</td> </tr> <tr> <td>101</td> <td>No data response</td> </tr> <tr> <td>110</td> <td>Implicit Writeback</td> </tr> <tr> <td>111</td> <td>Normal data response</td> </tr> </tbody> </table>	RS[2:0]	Response type	000	Idle state	001	Retry response	010	Deferred response	011	Reserved (not driven by the GMCH)	100	Hard Failure (not driven by the GMCH)	101	No data response	110	Implicit Writeback	111	Normal data response
RS[2:0]	Response type																			
000	Idle state																			
001	Retry response																			
010	Deferred response																			
011	Reserved (not driven by the GMCH)																			
100	Hard Failure (not driven by the GMCH)																			
101	No data response																			
110	Implicit Writeback																			
111	Normal data response																			

2.2. System Memory Interface Signals

Signal Name	Type	Description
SMAA[11:0] SMAB[7:4]# SBS[1:0]	O CMOS	Memory Address: SMAA[11:0] and SMAB[7:4]# are used to provide the multiplexed row and column address to DRAM. SBS[1:0] provide the Bank Select.
SMD[63:0]	I/O CMOS	Memory Data: These signals are used to interface to the DRAM data bus.
SDQM[7:0]	O CMOS	Input/Output Data Mask: These pins act as synchronized output enables during read cycles and as a byte enables during write cycles.
SCS[3:0]#	O CMOS	Chip Select: For the memory row configured with SDRAM, these pins perform the function of selecting the particular SDRAM components during the active state.
SRAS#	O CMOS	SDRAM Row Address Strobe: These signals drive the SDRAM array directly without any external buffers.
SCAS#	O CMOS	SDRAM Column Address Strobe: These signals drive the SDRAM array directly without any external buffers.
SWE#	O CMOS	Write Enable Signal: SWE# is asserted during writes to DRAM.
SCKE[1:0]	O CMOS	System Memory Clock Enable: SCKE SDRAM Clock Enable is used to signal a self-refresh or power-down command to an SDRAM array when entering system suspend.

2.3. Display Cache Interface Signals (82810-DC100 only)

Signal Name	Type	Description
LCS#	O CMOS	Chip Select: For the memory row configured with SDRAM, these pins perform the function of selecting the particular SDRAM components during the active state.
LDQM[3:0]	O CMOS	Input/Output Data Mask: These pins control the memory array and act as synchronized output enables during read cycles and as a byte enables during write cycles.
LSRAS#	O CMOS	SDRAM Row Address Strobe: The LSRAS# signal is used to generate SDRAM Command encoded on LSRAS#/LSCAS#/LWE# signals. When LSRAS# is sampled active at the rising edge of the SDRAM clock, the row address is latched into the SDRAMs.
LSCAS#	O CMOS	SDRAM Column Address Strobe: The LSCAS# signal is used to generate SDRAM Command encoded on LSRAS#/LSCAS#/LWE# signals. When LSCAS# is sampled active at the rising edge of the SDRAM clock, the column address is latched into the SDRAMs.
LMA[11:0]	O CMOS	Memory Address: LMA[11:0] is used to provide the multiplexed row and column address to DRAM.
LWE#	O CMOS	Write Enable Signal: LWE# is asserted during writes to DRAM.
LMD[31:0]	I/O CMOS	Memory Data: These signals are used to interface to the DRAM data bus of DRAM array.

2.4. Hub Interface Signals

Signal Name	Type	Description
HL[10:0]	I/O	Hub Interface Signals: Signals used for the hub interface.
HLSTRB	I/O	Packet Strobe: One of two differential strobe signals used to transmit or receive packet data.
HLSTRB#	I/O	Packet Strobe Compliment: One of two differential strobe signals used to transmit or receive packet data.
HUBREF	I Ref	HUB reference: Sets the differential voltage reference for the hub interface.
HCOMP	I/O	Hub Compensation Pad: Used to calibrate the hub interface buffers.

2.5. Display Interface Signals

Signal Name	Type	Description
VSYNC	O 3.3V	CRT Vertical Synchronization: This signal is used as the vertical sync (polarity is programmable) or "Vsync Interval".
HSYNC	O 3.3V	CRT Horizontal Synchronization: This signal is used as the horizontal sync (polarity is programmable) or "Hsync Interval".
IWASTE	I Ref	Waste Reference: This signal must be tied to ground.
IREF	I Ref	Set pointer resistor for the internal color palette DAC: A 178 ohm 1% resistor is recommended
RED	O Analog	CRT Analog video output from the internal color palette DAC: The DAC is designed for a 37.5 ohms equivalent load on each pin (e.g. 75 ohms resistor on the board, in parallel with the 75 ohms CRT load)
GREEN	O Analog	CRT Analog video output from the internal color palette DAC: The DAC is designed for a 37.5 ohms equivalent load on each pin (e.g. 75 ohms resistor on the board, in parallel with the 75 ohms CRT load)
BLUE	O Analog	CRT Analog video output from the internal color palette DAC: The DAC is designed for a 37.5 ohms equivalent load on each pin (e.g., 75 ohms resistor on the board, in parallel with the 75 ohms CRT load)
DDCSCL	I/OD CMOS	CRT Monitor DDC Interface Clock: (Also referred to as VESA™ "Display Data Channel"; also referred to as the "Monitor Plug-n-Play" interface.) For DDC1, DDCSCL and DDCSDA provides a unidirectional channel for Extended Display ID. For DDC2, DDCSCL and DDCSDA it can be used to establish a bi-directional channel based on I ² C protocol. The host can request Extended Display ID or Video Display Interface information over the DDC2 channel.
DDCSDA	I/OD CMOS	CRT Monitor DDC Interface Data:

2.6. Digital Video Output Signals/TV-Out Pins

Signal Name	Type	Description
TVCLKIN/INT#	I 1.8V	<p>Low Voltage TV Clock In (TV-Out Mode): In 1.8V TV-Out usage, the TVCLKIN pin functions as a pixel clock input to the GMCH from the TV encoder. The TVCLKIN frequency ranges from 20 MHz to 40 MHz depending on the mode (e.g., NTSC or PAL) and the overscan compensation values in the TV Encoder. CLKIN has a worse case duty cycle of 60%/40% coming in to the GMCH.</p> <p>Flat Panel Interrupt (LCD Mode): In Flat Panel usage, the INT# pin is asserted to cause an interrupt (typically, to indicate a hot plug or unplug of a flat panel). In Flat Panel usage, this pin is connected internally to a pull-up resistor.</p>
CLKOUT[1:0]	O 1.8V	LCD/TV Port Clock Out: These pins provide a differential pair reference clock that can run up to 112 MHz.
BLANK#	O 1.8V	Flicker Blank or Border Period Indication: BLANK# is a programmable output pin driven by the graphics control. When programmed as a blank period indication, this pin indicates active pixels excluding the border. When programmed as a border period indication, this pin indicates active pixel including the border pixels.
LTVDATA[11:0]	O 1.8V	LCD/TV Data: These signals are used to interface to the LCD/TV-out data bus.
TVVSYNC	O 1.8V	Vertical Sync: VSYNC signal for the LTV interface. The active polarity of the signal is programmable.
TVHSYNC	O 1.8V	Horizontal Sync: HSYNC signal for the LTV interface. The active polarity of the signal is programmable.
LTVCL	I/OD CMOS	LCD/TV Clock: Clock pin for 2-wire interface.
LTVDA	I/OD CMOS	LCD/TV Data: Data pin for 2-wire interface.

2.7. Power Signals

Signal Name	Type	Description
V_1.8	Power	Core Power (1.8V)
V_3.3	Power	I/O Buffer Power (3.3V)
VSUS_3.3	Power	System Memory Buffer Power (Separate 3.3V power plane for power down modes)
VCCDA	Power	Display Power Signal (Connect to an isolated 1.8V plane with VCCDACA1 and VCCDACA2)
VCCDACA1	Power	Display Power Signal (Connect to an isolated 1.8V plane with VCCDA and VCCDACA2)
VCCHA	Power	Isolated 1.8V Power
VCCBA	Power	Isolated 1.8V Power
VCCDACA2	Power	Display Power Signal (Connect to an isolated 1.8V plane with VCCDA and VCCDACA1)
VSSDA	Power	Display Ground Signal
VSSDACA	Power	Display Ground Signal
VSS	Power	Core Ground

2.8. Clock Signals

Signal Name	Type	Description
HCLK	I CMOS	Host Clock Input: Clock used on the host interface. Externally generated 66/100 MHz clock.
SCLK	I CMOS	System Memory Clock: Clock used on the output buffers of system memory. Externally generated 100 MHz clock.
LTCLK	O CMOS	Transmit Clock: LTCLK is an internally generated local memory clock used to clock the input buffers of the SDRAM devices of the display cache.
LOCLK	O CMOS	Output Clock: LOCLK is an internally generated clock used to drive LRCLK.
LRCLK	I CMOS	Receive Clock: LRCLK is a display cache clock used to clock the input buffers of the GMCH.
DCLKREF	I CMOS	Display Interface Clock: DCLKREF is a 48 MHz clock generated by an external clock synthesizer to the GMCH.
HLCLK	I CMOS	Hub Interface Clock: 66 MHz hub interface clock generated by an external clock synthesizer.

2.9. Miscellaneous Interface Signals

Signal Name	Type	Description
GTLREFA	I Ref	GTL Reference Voltage: Reference signal to the Host Interface.
GTLREFB	I Ref	GTL Reference Voltage: Reference signal to the Host Interface.
RESET#	I	Global Reset: Driven by the ICH/ICH0 when PCIRST# is active.

2.10. Power-Up/Reset Strap Options (82810)

Table 1 lists power-up options that are loaded into the 82810 GMCH during cold reset.

Table 1. Power-Up Options (82810)

Pin Location	Description
F22	XOR Chain Test Select: Set to 0 for normal operation. It must be set to 1 to enter XOR tree mode during reset. This pin must remain 1 during the entire XOR tree test.
F21	ALL Z Select: If the pin is set to 1, it will tri-state all signals during reset. For normal operation, this pin should be set to 0.
G23	Host Frequency Select: If this pin is set to 0 during reset, the host bus frequency is 66 Mhz. If the pin is set to 1, the host bus frequency is 100 MHz.
G22	In-Order Queue Depth Status: If set to 0 during reset, the IOQD is 4. If set to 1, the IOQD is 1.

2.11. Power-Up/Reset Strap Options (82810-DC100)

Table 2 list power-up options that are loaded into the 82810-DC100 GMCH during cold reset.

Table 2. Power-Up Options (82810-DC100)

Signal	Description
LMD[31]	XOR Chain Test Select: LMD[31] is set to 0 for normal operation. It must be set to 1 to enter XOR tree mode during reset. This signal must remain 1 during the entire XOR tree test.
LMD[30]	ALL Z select: If LMD[30] is set to 1, it will tri-state all signals during reset. For normal operation, LMD[30] should be set to 0
LMD[29]	Host Frequency Select: If LMD[29] is set to 0 during reset, the host bus frequency is 66 MHz. If LMD[29] is set to 1, the host bus frequency is 100 MHz.
LMD[28]	In-Order Queue Depth Status: The value on LMD[28] sampled at the rising edge of CPURST# reflects if the IOQD is set to 1 or 4. If LMD[28] is set to 0, the IOQD is 4. If LMD[28] is set to 1, the IOQD is 1.

3. Configuration Registers

This section describes the following register sets:

- PCI Configuration Registers (82810 and 82810-DC100). The GMCH contains PCI configuration registers for Device 0 (Host-hub interface Bridge/DRAM Controller) and Device 1 (GMCH internal graphics device).
- Display Cache Interface Registers (82810-DC100 only). This register set is used for configuration of the Display Cache (DC) interface. The registers are located in memory space. The memory space addresses listed are offsets from the base memory address programmed into the MMADR register (Device 1, PCI configuration offset 14h).
- Display Cache Detect and Diagnostic Registers (82810-DC100 only). This register set can be used for DC memory detection and testing. These registers are accessed via either I/O space or memory space. The memory space addresses listed are offsets from the base memory address programmed into the MMADR register (Device 1, PCI configuration offset 14h).

Note that the GMCH also contains an extensive set of registers and instructions for controlling its graphics operations. Intel graphics drivers provide the software interface at this architectural level. The register/instruction interface is transparent at the Application Programmers Interface (API) level and thus, beyond the scope of this document.

3.1. Register Nomenclature and Access Attributes

RO	Read Only. If a register is read only, writes to this register have no effect.
R/W	Read/Write. A register with this attribute can be read and written
R/WC	Read/Write Clear. A register bit with this attribute can be read and written. However, a write of a 1 clears (sets to 0) the corresponding bit and a write of a 0 has no effect.
R/WO	Read/Write Once. A register bit with this attribute can be written to only once after power up. After the first write, the bit becomes read only.
Reserved Bits	Some of the GMCH registers described in this section contain reserved bits. These bits are labeled "Reserved" or "Intel Reserved". Software must deal correctly with fields that are reserved. On reads, software must use appropriate masks to extract the defined bits and not rely on reserved bits being any particular value. On writes, software must ensure that the values of reserved bit positions are preserved. That is, the values of reserved bit positions must first be read, merged with the new values for other bit positions and then written back. Note the software does not need to perform read, merge, write operation for the configuration address register.
Reserved Registers	In addition to reserved bits within a register, the GMCH contains address locations in the configuration space of the Host-hub interface Bridge/DRAM Controller and the internal graphics device entities that are marked either "Reserved" or Intel Reserved". When a "Reserved" register location is read, a random value can be returned. ("Reserved" registers can be 8-, 16-, or 32-bit in size). Registers that are marked as "Reserved" must not be modified by system software. Writes to "Reserved" registers may cause system failure.
Default Value Upon Reset	Upon a Full Reset, the GMCH sets all of its internal configuration registers to predetermined default states. Some register values at reset are determined by external strapping options. The default state represents the minimum functionality feature set required to successfully bring up the system. Hence, it does not represent the optimal system configuration. It is the responsibility of the system initialization software (usually BIOS) to properly determine the DRAM configurations, operating parameters and optional system features that are applicable, and to program the GMCH registers accordingly.

3.2. PCI Configuration Space Access

The GMCH and the ICH are physically connected via the hub interface. From a configuration standpoint, the hub interface connecting the GMCH and the ICH is **logically PCI bus #0**. All devices internal to the GMCH and ICH appear to be on PCI bus #0. The system primary PCI expansion bus is physically attached to the ICH and, from a configuration standpoint, appears as a hierarchical PCI bus behind a PCI-to-PCI bridge. The primary PCI expansion bus connected to the ICH has a programmable PCI Bus number.

Note: Even though the primary PCI bus is referred to as PCI0 in this document it is not PCI bus #0 from a configuration standpoint.

The GMCH contains two PCI devices within a single physical component. The configuration registers for both Device 0 and 1 are mapped as devices residing on PCI bus #0.

- Device 0: Host-hub interface Bridge/DRAM Controller. Logically this appears as a PCI device residing on PCI bus #0. Physically Device 0 contains the PCI registers, DRAM registers, and other GMCH specific registers.
- Device 1: GMCH internal graphics device. These registers contain the PCI registers for the GMCH internal graphics device.

Note that a physical PCI bus #0 does not exist. The hub interface and the internal devices in the GMCH and ICH logically constitute PCI Bus #0 to configuration software.

3.2.1. PCI Bus Configuration Mechanism

The PCI Bus defines a slot based "configuration space" that allows each device to contain up to 8 functions with each function containing up to 256 8-bit configuration registers. The PCI specification defines two bus cycles to access the PCI configuration space: Configuration Read and Configuration Write. Memory and I/O spaces are supported directly by the processor. Configuration space is supported by a mapping mechanism implemented within the GMCH. The PCI specification defines two mechanisms to access configuration space, Mechanism #1 and Mechanism #2.

The GMCH supports only Mechanism #1

The configuration access mechanism makes use of the CONFIG_ADDRESS Register and CONFIG_DATA Register. To reference a configuration register a Dword I/O write cycle is used to place a value into CONFIG_ADDRESS that specifies the PCI bus, the device on that bus, the function within the device, and a specific configuration register of the device function being accessed. CONFIG_ADDRESS[31] must be 1 to enable a configuration cycle. CONFIG_DATA then becomes a window into the four bytes of configuration space specified by the contents of CONFIG_ADDRESS. Any read or write to CONFIG_DATA will result in the GMCH translating the CONFIG_ADDRESS into the appropriate configuration cycle.

The GMCH is responsible for translating and routing the processor I/O accesses to the CONFIG_ADDRESS and CONFIG_DATA registers to internal GMCH configuration registers, the internal graphic device, or the hub interface.

3.2.2. Logical PCI Bus #0 Configuration Mechanism

The GMCH decodes the Bus Number (bits 23:16) and the Device Number fields of the CONFIG_ADDRESS register. If the Bus Number field of CONFIG_ADDRESS is 0 the configuration cycle is targeting a PCI Bus #0 device.

- Device #0: The Host-hub interface Bridge/DRAM Controller entity within the GMCH is hardwired as Device #0 on PCI Bus #0.
- Device #1: The internal graphics device entity within the GMCH is hardwired as Device #1 on PCI Bus #0. Configuration cycles to one of the GMCH internal devices are confined to the GMCH and not sent over the hub interface. Note: Accesses to devices #2 to #31 on PCI Bus #0 will be forwarded over the hub interface.

3.2.3. Primary PCI (PCI0) and Downstream Configuration Mechanism

If the Bus Number in the CONFIG_ADDRESS is non-zero the GMCH will generate a configuration cycle over the hub interface. The ICH compares the non-zero Bus Number with the SECONDARY BUS NUMBER and SUBORDINATE BUS NUMBER registers of its P2P bridges to determine if the configuration cycle is meant for Primary PCI (PCI0), or a downstream PCI bus.

3.2.4. Internal Graphics Device Configuration Mechanism

From the chipset configuration perspective the internal graphics device is seen as a PCI device (device #1) on PCI Bus #0. Configuration cycles that target device #1 on PCI Bus #0 will be claimed by the internal graphics device and will not be forwarded via hub interface to the ICH.

3.2.5. GMCH Register Introduction

The GMCH contains two sets of software accessible registers, accessed via the Host I/O address space:

- Control registers I/O mapped into the host I/O space, which control access to PCI configuration space (see section entitled I/O Mapped Registers)
- Internal configuration registers residing within the GMCH are partitioned into two logical device register sets ("logical" since they reside within a single physical device). The first register set is dedicated to Host-hub interface Bridge/DRAM Controller functionality (controls PCI0 such as DRAM configuration, other chip-set operating parameters and optional features). The second register block is dedicated to the internal graphics device in the GMCH.

The GMCH supports PCI configuration space accesses using the mechanism denoted as Configuration Mechanism #1 in the PCI specification.

The GMCH internal registers (both I/O Mapped and Configuration registers) are accessible by the host. The registers can be accessed as Byte, Word (16-bit), or Dword (32-bit) quantities, with the exception of CONFIG_ADDRESS which can only be accessed as a Dword. All multi-byte numeric fields use "little-endian" ordering (i.e., lower addresses contain the least significant parts of the field).

3.3. I/O Mapped Registers

GMCH contains two registers that reside in the CPU I/O address space – the Configuration Address (CONFIG_ADDRESS) Register and the Configuration Data (CONFIG_DATA) Register. The Configuration Address Register enables/disables the configuration space and determines what portion of configuration space is visible through the Configuration Data window.

3.3.1. CONFIG_ADDRESS—Configuration Address Register

I/O Address: 0CF8h Accessed as a DWord
 Default Value: 00000000h
 Access: Read/Write
 Size: 32 bits

CONFIG_ADDRESS is a 32 bit register accessed only when referenced as a Dword. A Byte or Word reference will "pass through" the Configuration Address Register and the hub interface onto the PCI #0 bus as an I/O cycle. The CONFIG_ADDRESS register contains the Bus Number, Device Number, Function Number, and Register Number for which a subsequent configuration access is intended.

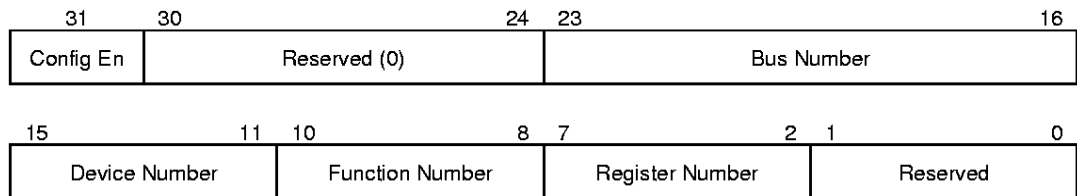

Bit	Descriptions
31	Configuration Enable (CFGE). 1 = Enable accesses to PCI configuration space 0 = Disable accesses to PCI configuration space
30:24	Reserved (These bits are read only and have a value of 0).
23:16	Bus Number. When the Bus Number is programmed to 00h the target of the Configuration Cycle is either a hub interface agent GMCH or the ICH. The Configuration Cycle is forwarded to the hub interface if the Bus Number is programmed to 00h and the GMCH is not the target.
15:11	Device Number. This field selects one agent on the PCI bus selected by the Bus Number. When the Bus Number field is "00" the GMCH decodes the Device Number field. The GMCH is always Device Number 0 for the Host-Hub interface bridge/DRAM Controller entity and Device Number 1 for the internal graphics device. Therefore, when the Bus Number =0 and the Device Number=0 or 1 the internal GMCH devices are selected. For Bus Numbers resulting in the hub interface configuration cycles the GMCH propagates the Device Number field as HA[15:11].
10:8	Function Number. This field is mapped to HA[10:8] during the hub interface configuration cycles. This allows the configuration registers of a particular function in a multi-function device to be accessed. The GMCH ignores configuration cycles to its two internal Devices if the function number is not equal to 0.

Bit	Descriptions
7:2	Register Number. This field selects one register within a particular Bus, Device, and Function as specified by the other fields in the Configuration Address Register. This field is mapped to HA[7:2] during the hub interface Configuration cycles.
1:0	Reserved.

3.3.2. CONFIG_DATA—Configuration Data Register

I/O Address: 0CFCh
 Default Value: 00000000h
 Access: Read/Write
 Size: 32 bits

CONFIG_DATA is a 32 bit read/write window into configuration space. The portion of configuration space that is referenced by CONFIG_DATA is determined by the contents of CONFIG_ADDRESS.

Bit	Descriptions
31:0	Configuration Data Window (CDW). If bit 31 of CONFIG_ADDRESS is 1, any I/O reference that falls in the CONFIG_DATA I/O space will be mapped to configuration space using the contents of CONFIG_ADDRESS.

3.4. Host-Hub Interface Bridge/DRAM Controller Device Registers (Device 0)

Table 3 shows the GMCH configuration space for device #0.

Table 3. GMCH PCI Configuration Space (Device 0)

Address Offset	Register Symbol	Register Name	Default Value	Access
00–01h	VID	Vendor Identification	8086h	RO
02–03h	DID	Device Identification	7120h/7122h	RO
04–05h	PCICMD	PCI Command Register	0006h	R/W
06–07h	PCISTS	PCI Status Register	0080h	RO, R/WC
08h	RID	Revision Identification	00h	RO
09h	—	Reserved	00h	—
0Ah	SUBC	Sub-Class Code	00h	RO
0Bh	BCC	Base Class Code	06h	RO
0Ch	—	Reserved	00h	—
0Dh	MLT	Master Latency Timer	00h	RO
0Eh	HDR	Header Type	00h	RO
0Fh	—	Reserved	—	—
10–2Bh	—	Reserved	—	—
2C–2Dh	SVID	Subsystem Vendor Identification	0000h	R/WO
2E–2Fh	SID	Subsystem Identification	0000h	R/WO
30–33h	—	Reserved	—	—
34h	CAPPTR	Capabilities Pointer	00h	RO
35–4Fh	—	Reserved	—	—
50h	GMCHCFG	GMCH Configuration	60h	R/W
51h	PAM	Programmable Attributes	00h	R/W
52h	DRP	DRAM Row Population	00h	R/W
53h	DRAMT	DRAM Timing Register	08h	R/W
54–57h	—	Reserved	—	—
58h	FDHC	Fixed DRAM Hole Control	00h	R/W
58–6Fh	—	Reserved	—	—
70h	SMRAM	System Management RAM Control	00h	R/W
72–73h	MISSC	Miscellaneous Control	0000h	R/W
74–7Fh	—	Reserved	—	—
80h	MISSC2	Miscellaneous Control 2	00h	R/W
81–91h	—	Reserved	—	—
92–93h	BSC	Buffer Strength Control	FFFFh	R/W
94–FFh	—	Reserved	—	—

3.4.1. VID—Vendor Identification Register (Device 0)

Address Offset: 00–01h
 Default Value: 8086h
 Attribute: Read Only
 Size: 16 bits

The VID Register contains the vendor identification number. This 16-bit register combined with the Device Identification Register uniquely identify any PCI device. Writes to this register have no effect.

Bit	Description
15:0	Vendor Identification Number. This is a 16-bit value assigned to Intel. Intel VID = 8086h.

3.4.2. DID—Device Identification Register (Device 0)

Address Offset: 02–03h
 Default Value: 82810 = 7120h
 82810-DC100 = 7122h
 Attribute: Read Only
 Size: 16 bits

This 16-bit register combined with the Vendor Identification register uniquely identifies any PCI device. Writes to this register have no effect.

Bit	Description
15:0	Device Identification Number. This is a 16 bit value assigned to the GMCH Host-hub interface Bridge/DRAM Controller Device #0.

3.4.3. PCICMD—PCI Command Register (Device 0)

Address Offset: 04–05h
 Default: 0006h
 Access: Read/Write
 Size: 16 bits

This 16-bit register provides basic control over the GMCH PCI0 (i.e., Hub-Interface) interface’s ability to respond to Hub Interface cycles.

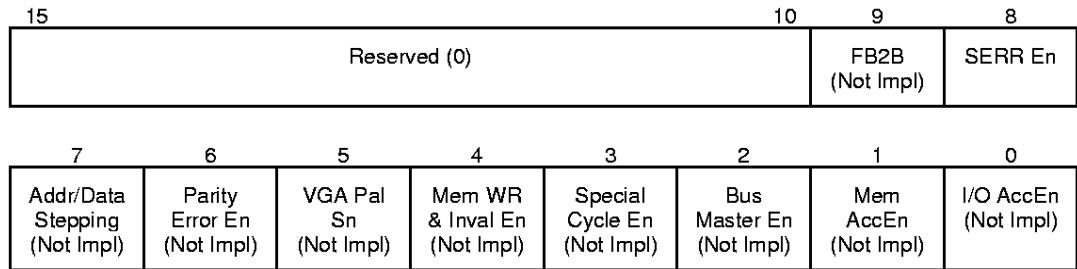

Bit	Descriptions
15:10	Reserved.
9	Fast Back-to-Back. (Not implemented; hardwired to 0). Writes to this bit position have no effect
8	SERR Enable (SERRE). This bit is a global enable bit for Device #0 SERR messaging. The GMCH does not have an SERR# signal. The GMCH communicates the SERR condition by sending an SERR message to the ICH. If this bit is set to a 1, the GMCH is enabled to generate SERR messages over the hub interface for specific Device #0 error conditions (Note: the only SERR condition for the GMCH is Received Target Abort, therefore there are no other SERR enable bits in the GMCH). If SERRE is reset to 0, then the SERR message is not generated by the GMCH for Device #0. NOTE: This bit only controls SERR messaging for the Device #0.
7	Address/Data Stepping. (Not implemented; hardwired to 0). Writes to this bit position have no effect.
6	Parity Error Enable (PERRE). (Not implemented; hardwired to 0). Writes to this bit position have no effect.
5	VGA Palette Snoop. (Not implemented, hardwired to 0). Writes to this bit position have no effect
4	Memory Write and Invalidate Enable. (Not implemented; hardwired to 0). Writes to this bit position have no effect
3	Special Cycle Enable. (Not implemented; hardwired to 0). Writes to this bit position have no effect
2	Bus Master Enable (BME). (Not implemented: hardwired to 1). GMCH will always be a Bus Master. Writes to this bit position have no effect
1	Memory Access Enable (MAE). (Not implemented; hardwired to 1). Writes to this bit position have no effect
0	I/O Access Enable (IOAE). (Not implemented by the GMCH: hardwired to 0). Writes to this bit position have no effect

3.4.4. PCISTS—PCI Status Register (Device 0)

Address Offset: 06–07h
 Default Value: 0080h
 Access: Read Only, Read/Write Clear
 Size: 16 bits

PCISTS is a 16 bit status register that reports the occurrence of error events on the hub interface.



Bit	Descriptions
15	Detected Parity Error (DPE) —RO. This bit is hardwired to 0. Writes to this bit position have no effect.
14	Signaled System Error (SSE)—RWC. This bit is set to 1 when the GMCH Device #0 generates an SERR message over hub interface for any enabled Device #0 error condition. Device #0 error conditions are enabled in the PCICMD register. Device #0 error flags are read/reset from the PCISTS register. Software sets SSE to 0 by writing a 1 to this bit. (Note: the only SERR condition for GMCH is Received Target Abort, therefore there are no other SERR enable bits in the GMCH).
13	Received Master Abort Status (RMAS) —RWC. This bit is set when the GMCH generates a Hub-Interface request that receives a Master Abort completion packet. Software clears this bit by writing a 1 to it.
12	Received Target Abort Status (RTAS) —RWC. This bit is set when the GMCH generates a Hub Interface request that receives a Target Abort completion packet. Software clears this bit by writing a 1 to it.
11	Signaled Target Abort Status (STAS) —RO. (Not implemented; hardwired to a 0). Writes to this bit position have no effect.
10:9	DEVSEL# Timing (DEVT) —RO. These bits are hardwired to "00". Writes to these bit positions have no effect. Device #0 does not physically connect to PCI0. These bits are set to "00" (fast decode) so that optimum DEVSEL timing for PCI0 is not limited by the GMCH.
8	Data Parity Detected (DPD) —RO. This bit is hardwired to a 0. Writes to this bit position have no effect.
7	Fast Back-to-Back (FB2B) —RO. This bit is hardwired to 1. Writes to these bit positions have no effect. Device #0 does not physically connect to PCI. This bit is set to 1 (indicating fast back-to-back capability) so that the optimum setting for PCI is not limited by the GMCH.
6:5	Reserved.
4	Capability List (CLIST)—RO. This bit is hardwired to 0, to indicate to the configuration software that this device/function does not implement a new list of features, and that there is NO CAPPTR.
3:0	Reserved.

3.4.5. RID—Revision Identification Register (Device 0)

Address Offset: 08h
 Default Value: 02h
 Access: Read Only
 Size: 8 bits

This register contains the revision number of the GMCH Device 0. These bits are read only and writes to this register have no effect.

Bit	Description
7:0	Revision Identification Number. This is an 8-bit value that indicates the revision identification number for the GMCH device #0. For the A-2 Stepping, this value is 02h.

3.4.6. SUBC—Sub-Class Code Register (Device 0)

Address Offset: 0Ah
 Default Value: 00h
 Access: Read Only
 Size: 8 bits

This register contains the Sub-Class Code for the GMCH Device #0. This code is 00h indicating a Host Bridge device. The register is read only.

Bit	Description
7:0	Sub-Class Code (SUBC). This is an 8-bit value that indicates the category of Bridge into which the GMCH falls. The code is 00h indicating a Host Bridge.

3.4.7. BCC—Base Class Code Register (Device 0)

Address Offset: 0Bh
 Default Value: 06h
 Access: Read Only
 Size: 8 bits

This register contains the Base Class Code of the GMCH Device #0. This code is 06h indicating a Bridge device. This register is read only.

Bit	Description
7:0	Base Class Code (BASEC). This is an 8-bit value that indicates the Base Class Code for the GMCH. This code has the value 06h, indicating a Bridge device.

3.4.8. MLT—Master Latency Timer Register (Device 0)

Address Offset: 0Dh
 Default Value: 00h
 Access: Read Only
 Size: 8 bits

MLT Function has moved to the ICH/ICH0, therefore this register is not implemented in the GMCH.

Bit	Descriptions
7:0	Master Latency Timer Value. This read only field always returns 0's.

3.4.9. HDR—Header Type Register (Device 0)

Offset: 0Eh
 Default: 00h
 Access: Read Only
 Size: 8 bits

This register identifies the header layout of the configuration space. No physical register exists at this location.

Bit	Descriptions
7:0	Header Type. This read only field always returns 0's.

3.4.10. SVID—Subsystem Vendor Identification Register (Device 0)

Offset: 2C–2Dh
 Default: 0000h
 Access: Read/Write Once
 Size: 16 bits

Bit	Description
15:0	Subsystem Vendor ID—R/WO. This value is used to identify the vendor of the subsystem. This field should be programmed by BIOS during boot-up. Once written, this register becomes read only. This register can only be cleared by a Reset.

3.4.11. SID—Subsystem Identification Register (Device 0)

Offset: 2E–2Fh
 Default: 0000h
 Access: Read/Write Once
 Size: 16 bits

Bit	Description
15:0	Subsystem ID—R/WO. This value is used to identify a particular subsystem. This field should be programmed by BIOS during boot-up. Once written, this register becomes read only. This Register can only be cleared by a reset.

3.4.12. CAPPTR—Capabilities Pointer (Device 0)

Offset: 34h
 Default: 00h
 Access: Read Only
 Size: 8 bits

The CAPPTR provides the offset that is the pointer to the location where the AGP registers are located.

Bit	Description
7:0	Pointer to the Start of AGP Register Block. Since there is no AGP bus on the GMCH, this field is set to 00h.

3.4.13. GMCHCFG—GMCH Configuration Register (Device 0)

Offset: 50h
 Default: 60h
 Access: Read/Write, Read Only
 Size: 8 bits

7	6	5	4	3	2	1	0
Reserved	CPU Latency Timer	Reserved	Reserved	DRAM Pg Closing Policy	Reserved	D8 Hole Enable	CD Hole Enable

Bit	Description
7	Reserved
6	<p>CPU Latency Timer (CLT).</p> <p>1 = A “deferrable” CPU cycle will only be Deferred after in has been held in a “Snoop Stall” for 31 clocks and another ADS# has arrived.</p> <p>0 = A “deferrable” CPU cycle will be Deferred immediately after the GMCH receives another ADS#</p>
5:4	Reserved
3	<p>DRAM Page Closing Policy (DPCP). This bit controls whether the GMCH will precharge bank or precharge all during the service of a page miss.</p> <p>1 = The GMCH will precharge all during the service of a page miss.</p> <p>0 = The GMCH will precharge bank during the service of a page miss.</p>
2	Reserved
1	<p>D8 Hole Enable (D8HEN).</p> <p>1 = Enable. All accesses to the address range 000D8000h–000DFFFh are forwarded on to the ICH, independent of the programming of the PAM registers.</p> <p>0 = Disable. The “D8 Hole” region is controlled by bits 3:2 of the PAM registers.</p>
0	<p>CD Hole Enable (CDHEN).</p> <p>1 = Enable. All accesses to the address range 000DC000h–000DFFFFh are forwarded on to ICH, independent of the programming of the PAM register.</p> <p>0 = Disable. The “CD Hole” region is controlled by bits 3 & 2 of the PAM Register.</p>

3.4.14. PAMR—Programmable Attributes Register (Device 0)

Address Offset: 51h
 Default Value: 00h
 Access: Read/Write
 Size: 8 bits

The Programmable Attributes Register controls accesses to the memory range 000C0000h to 000FFFFFFh.

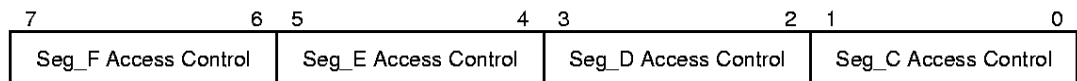

Bit	Description
7:6	<p>Seg_F Access Control. This field controls accesses to 000F0000 to 000FFFFFF.</p> <p>00 = Disabled, all accesses are forwarded to the ICH</p> <p>01 = Read Only, reads are directed to system memory DRAM and writes are forwarded to the ICH</p> <p>10 = Write Only, writes are directed to system memory DRAM and reads are forwarded to the ICH</p> <p>11 = Read/Write, all accesses are directed to system memory DRAM.</p>
5:4	<p>Seg_E Access Control. This field controls accesses to 000E0000 to 000EFFFF.</p> <p>00 = Disabled, all accesses are forwarded to the ICH</p> <p>01 = Read Only, reads are directed to system memory DRAM and writes are forwarded to the ICH</p> <p>10 = Write Only, writes are directed to system memory DRAM and reads are forwarded to the ICH</p> <p>11 = Read/Write, all accesses are directed to system memory DRAM.</p>
3:2	<p>Seg_D Access Control. This field controls accesses to 000D0000 to 000DFFFF.</p> <p>00 = Disabled, all accesses are forwarded to the ICH</p> <p>01 = Read Only, reads are directed to system memory DRAM and writes are forwarded to the ICH</p> <p>10 = Write Only, writes are directed to system memory DRAM and reads are forwarded to the ICH</p> <p>11 = Read/Write, all accesses are directed to system memory DRAM.</p>
1:0	<p>Seg_C Access Control. This field controls accesses to 000C0000 to 000CFFFF.</p> <p>00 = Disabled, all accesses are forwarded to the ICH</p> <p>01 = Read Only, reads are directed to system memory and writes are forwarded to the ICH</p> <p>10 = Write Only, writes are directed to system memory and reads are forwarded to the ICH</p> <p>11 = Read/Write, all accesses are directed to system memory.</p>

CD Hole (DC000h–DFFFFh)

This 16 KB area is controlled by 2 sets of attribute bits. Host-initiated cycles in this region are forwarded to the ICH based upon the programming of PAM[3:2] and the CDHEN bit in the GMCHCFG register.

Video Buffer Area (A0000h–BFFFFh)

This 128 KB area is not controlled by attribute bits. The host-initiated cycles in this region are always forwarded to either the Graphics device or to the ICH unless this range is accessed in SMM mode. Routing of these accesses is controlled by the Graphics Mode Select field of the SMRAM register.

This area can be programmed as SMM area via the SMRAM register. This range can not be accessed from the hub interface.

3.4.15. DRP—DRAM Row Population Register (Device 0)

Address Offset: 52h
 Default Value: 00h
 Access: Read/Write (read only)
 Size: 8 bits

GMCH supports 4 physical rows of system memory in 2 DIMMs. The width of a row is 64 bits. The DRAM Row Population Register defines the population of each Side of each DIMM. Note: this entire register becomes read only when the SMM Space Locked (D_LCK) bit is set in the SMRAM—System Management RAM Control Register (offset 70h).

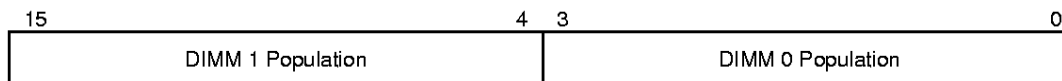

Bit	Description
7:4	DIMM 1 Population. This field indicates the population of DIMM 1. (See table below)
3:0	DIMM 0 Population. This field indicates the population of DIMM 0. (See table below)

Table 4. Programming DRAM Row Population Register Fields

Field Value (Hex)	Size	Technology	Population	Population
0	0 MB		Empty	Empty
1	8 MB	16Mb	4x(1Mx16)	Empty
3	16 MB	16Mb	4x(1Mx16)	4x(1Mx16)
4	16 MB	16Mb	8x(2Mx8)	Empty
5	24 MB	16Mb	8x(2Mx8)	4x(1Mx16)
6	32 MB	16Mb	8x(2Mx8)	8x(2Mx8)
7	32 MB	64Mb	4x(4Mx16)	Empty
7	32 MB	128Mb	2x(4Mx32)	Empty
8	48 MB	Mixed	4x(4Mx16)	8x(2Mx8)
8	48 MB	64Mb	4x(4Mx16)	2x(2Mx32)
8	48 MB	Mixed	2x(4Mx32)	2x(2Mx32)
9	64 MB	64Mb	4x(4Mx16)	4x(4Mx16)
9	64 MB	128Mb	2x(4Mx32)	2x(4Mx32)
A	64 MB	64Mb	8x(8Mx8)	Empty
A	64 MB	128Mb	4x(8Mx16)	Empty
B	96 MB	64Mb	8x(8Mx8)	4x(4Mx16)
B	96 MB	128Mb	4x(8Mx16)	2x(4Mx32)
B	96 MB	Mixed	4x(8Mx16)	4x(4Mx16)
C	128 MB	64Mb	8x(8Mx8)	8x(8Mx8)
C	128 MB	128Mb	4x(8Mx16)	4x(8Mx16)
D	128 MB	128Mb	8x(16Mx8)	Empty
E	192 MB	128Mb	8x(16Mx8)	4x(8Mx16)
E	192 MB	Mixed	8x(16Mx8)	8x(8Mx8)
F	256 MB	128Mb	8x(16Mx8)	8x(16Mx8)

3.4.16. DRAMT—DRAM Timing Register (Device 0)

Address Offset: 53h
 Default Value: 08h
 Access: Read/Write
 Size: 8 bits

The DRAMT Register controls the operating mode and the timing of the DRAM Controller.

7	5	4	3	2	1	0
SDRAM Mode Select		DRAM Cycle Time	Intel Reserved	CAS# Latency	SDRAM RAS# to CAS# Dly	SDRAM RAS# Precharge

Bit	Description										
7:5	<p>SDRAM Mode Select (SMS). These bits select the operational mode of the GMCH DRAM interface. The special modes are intended for initialization at power up.</p> <table border="1"> <thead> <tr> <th style="text-align: center;">SMS</th> <th style="text-align: center;">Mode</th> </tr> </thead> <tbody> <tr> <td style="text-align: center;">000</td> <td>DRAM in Self-Refresh Mode, Refresh Disabled (Default)</td> </tr> <tr> <td style="text-align: center;">001</td> <td>Normal Operation, refresh 15.6usec</td> </tr> <tr> <td style="text-align: center;">010</td> <td>Normal Operation, refresh 7.8usec</td> </tr> <tr> <td style="text-align: center;">011</td> <td>Reserved</td> </tr> </tbody> </table> <p>NOP Command Enabled. In this mode all CPU cycles to SDRAM result in a NOP Command on SDRAM interface.</p> <p>All Bank Precharge Enable. In this mode CPU cycles to SDRAM result in an all bank precharge command on the SDRAM interface.</p> <p>Mode Register Set Enable. In this mode all CPU cycles to SDRAM result in a mode register set command on the SDRAM interface. The Command is driven on the SMAA[11:0] and the SBS[0] lines. SMAA[2:0] must always be driven to 010 for burst of 4 mode. SMAA[3] must be driven to 1 for interleave wrap type. SMAA[4] needs to be driven to the value programmed in the CAS# Latency bit. SMAA[6:5] should always be driven to 01. SMAA[11:7] and SBS[0] must be driven to 000000. BIOS must calculate and drive the correct host address for each row of memory such that the correct command is driven on the SMAA[11:0] and SBS[0] lines.</p> <p>CBR Enable. In this mode all CPU cycles to SDRAM result in a CBR cycle on the SDRAM interface.</p> <p>Note: BIOS must take into consideration SMAB inversion when programming DIMM 2.</p>	SMS	Mode	000	DRAM in Self-Refresh Mode, Refresh Disabled (Default)	001	Normal Operation, refresh 15.6usec	010	Normal Operation, refresh 7.8usec	011	Reserved
SMS	Mode										
000	DRAM in Self-Refresh Mode, Refresh Disabled (Default)										
001	Normal Operation, refresh 15.6usec										
010	Normal Operation, refresh 7.8usec										
011	Reserved										
4	<p>DRAM Cycle Time (DCT). This bit controls the number of SCLKs for an access cycle.</p> <table border="1"> <thead> <tr> <th style="text-align: center;">Bit4</th> <th style="text-align: center;">Tras</th> <th style="text-align: center;">Trc</th> </tr> </thead> <tbody> <tr> <td style="text-align: center;">0</td> <td>5 SCLKs</td> <td>7 SCLKs (Default)</td> </tr> <tr> <td style="text-align: center;">1</td> <td>6 SCLKs</td> <td>8 SCLKs</td> </tr> </tbody> </table>	Bit4	Tras	Trc	0	5 SCLKs	7 SCLKs (Default)	1	6 SCLKs	8 SCLKs	
Bit4	Tras	Trc									
0	5 SCLKs	7 SCLKs (Default)									
1	6 SCLKs	8 SCLKs									
3	Intel Reserved.										

Bit	Description
2	CAS# Latency (CL). This bit controls the number of CLKs between when a read command is sampled by the SDRAMs and when the GMCH samples read data from the SDRAMs. 0 = 3 SCLKs (Default) 1 = 2 SCLKs
1	SDRAM RAS# to CAS# Delay (SRCD). This bit controls the number of SCLKs from a Row Activate command to a read or write command. 0 = 3 SCLKs (Default) 1 = 2 SCLKs
0	SDRAM RAS# Precharge (SRP). This bit controls the number of SCLKs for RAS# precharge. 0 = 3 SCLKs (Default) 1 = 2 SCLKs

3.4.17. FCHC—Fixed DRAM Hole Control Register (Device 0)

Offset: 58h
 Default: 00h
 Access: Read/Write
 Size: 8 bits

This 8-bit Register Controls 1 fixed DRAM holes: 15–16MB.

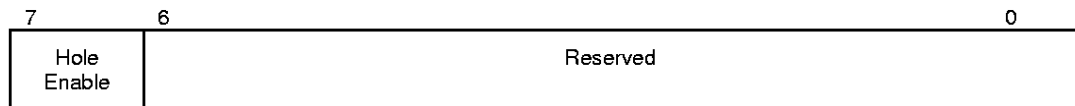

Bit	Description
7	Hole Enable (HEN)—RW. This Bit enables a memory hole in DRAM space. Host cycles matching an enabled hole are passed on to the ICH/ICH0 through the Hub Interface. Hub Interface cycles matching an enabled hole will be ignored by the GMCH. Note that the hole is not re-mapped 0 = Disabled (Default) 1 = Enabled (15MB–16MB; 1MB size)
6:0	Reserved

3.4.18. SMRAM—System Management RAM Control Register (Device 0)

Address Offset: 70h
 Default Value: 00h
 Access: Read/Write
 Size: 8 bits

The SMRAM register controls how accesses to Compatible and Extended SMRAM spaces are treated, and how much (if any) memory used from the System to support both SMRAM and Graphics Local Memory needs.

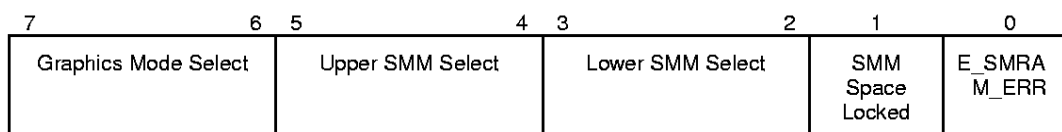

Bit	Description
7:6	<p>Graphics Mode Select (GMS). This field is used to enable/disable the internal graphics device and select the amount of system memory that is used to support the internal graphics device.</p> <p>00 = Graphics Device Disabled, No memory used (Device 1 is not accessible in this case)</p> <p>01 = Reserved</p> <p>10 = Graphics Device Enabled, 512 KB of memory used</p> <p>11 = Graphics Device Enabled 1 MB of memory used</p> <p>Note: When the Graphics Device is Disabled (00) the graphics device and all of its memory and I/O functions are disabled and the clocks to this logic are turned off, memory accesses to the VGA range.</p> <p>The 512 KB and 1 MB space selected by this field is used by video BIOS for handling support of VGA when no GMCH graphics driver is present (e.g., a DOS boot).</p> <p>(A0000h–BFFFFh) will be forwarded on to the hub interface, and no system memory is used to support the internal graphics device. When this field is non-zero the graphics device of the GMCH and all of its memory and I/O functions are enabled, all non-SMM memory accesses to the VGA range will be handled internally and the selected amount of system memory (0, 512K or 1M) is used from system memory to support the internal graphics device.</p> <p>Once D_LCK is set, these bits becomes read only.</p>

Bit	Description
5:4	<p>Upper SMM Select (USMM). This field is used to enable/disable the various SMM memory ranges above 1Meg. TSEG is a block of memory (Used from System Memory at [TOM-Size] : [TOM]) that is only accessible by the processor and only while operating in SMM mode. HSEG is a Remap of the AB segment at FEEA0000 : FEEBFFFF. Both of these areas, when enabled, are usable as SMM RAM, Non-SMM Operations that use these address ranges are forwarded to hub interface. HSEG is ONLY enabled if LSMM = 00.</p> <p>00 = TSEG and HSEG are both Disabled</p> <p>01 = TSEG is Disabled, HSEG is Conditionally Enabled</p> <p>10 = TSEG is Enabled as 512 KB and HSEG is Conditionally Enabled</p> <p>11 = TSEG is Enabled as 1 MB and HSEG is Conditionally Enabled</p> <p>Once D_LCK is set, these bits becomes read only.</p>
3:2	<p>Lower SMM Select (LSMM). This field controls the definition of the A&B segment SMM space</p> <p>00 = AB segment Disabled</p> <p>01 = AB segment Enabled as General System RAM</p> <p>10 = AB segment Enabled as SMM Code RAM Shadow. Only SMM Code Reads can access DRAM in the AB segment, SMM Data operations and all Non-SMM Operations go to either the internal Graphics Device or are broadcast on hub interface. 11 = AB segment Enabled as SMM RAM. All SMM operations to the AB segment are serviced by DRAM, all Non-SMM Operations go to either the internal Graphics Device or are broadcast on hub interface.</p> <p>When D_LCK is set bit 3 becomes Read_Only, and bit 2 is Writable ONLY if bit 3 is a "1".</p>
1	<p>SMM Space Locked (D_LCK). When D_LCK is set to 1 then D_LCK, GMS, USMM, and the most significant bit of LSMM become read only. D_LCK can be set to 1 via a normal configuration space write but can only be cleared by a power-on reset. The combination of D_LCK and LSMM provide convenience with security. The BIOS can use LSMM=01 to initialize SMM space and then use D_LCK to "lock down" SMM space in the future so that no application software (or BIOS itself) can violate the integrity of SMM space, even if the program has knowledge of the LSMM function. This bit also Locks the DRP register.</p>
0	<p>E_SMRAM_ERR (E_SMERR). This bit is set when CPU accesses the defined memory ranges in Extended SMRAM (HSEG or TSEG) while not in SMM mode. It is the software's responsibility to clear this bit. The software must write a 1 to this bit to clear it This bit is Not set for the case of an Explicit Write Back operation.</p>

3.4.19. MISCC—Miscellaneous Control Register (Device 0)

Address Offset: 72–73h
 Default Value: 0000h
 Access: Read/Write

This register contain miscellaneous control bits for the GMCH. Bits[7:3] are locked (read-only) when MISCC[P_CLK; bit 3] = 1.

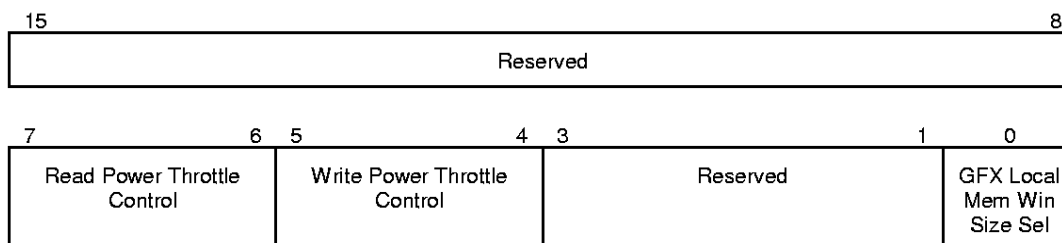

Bit	Description
15:8	Reserved
7:6	Read Power Throttle Control. These bits select the Power Throttle Bandwidth Limits for Read operations to System Memory. 00 = No Limit (Default) 01 = Limit at 87 ½ % 10 = Limit at 75 % 11 = Limit at 62 ½ %
5:4	Write Power Throttle Control. These bits select the Power Throttle Bandwidth Limits for Write operations to System Memory. 00 = No Limit (Default) 01 = Limit at 62.5% 10 = Limit at 50% 11 = Limit at 37.5%
3	Power Throttle Lock (P_LCK). 1 = Locked. Bits 7:3 of the MISCC register are read-only. Once this bit is set to 1, it can only be cleared to 0 by a hardware reset. 0 = Not locked.
2:1	Reserved.
0	Graphics Display Cache Window Size Select. 0 = 64 MB (default) 1 = 32 MB. See GMADR Register (Device 1).

3.4.20. MISCC2—Miscellaneous Control 2 Register (Device 0)

Address Offset: 80h
 Default Value: 00h
 Access: Read/Write

This register controls miscellaneous functionality in the GMCH.

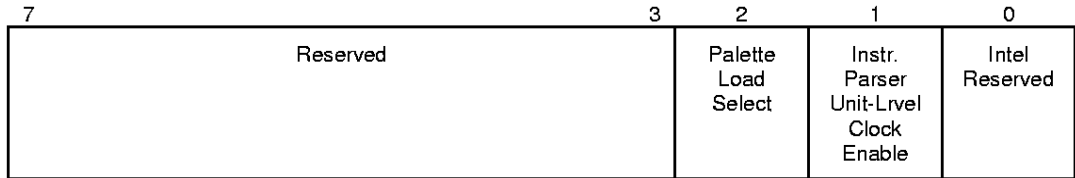

Bit	Description
7:3	Reserved
2	<p>Palette Load Select. This bit controls how the palette is loaded in the GMCH. This bit must be programmed to 1 for proper operation.</p> <p>1 = Enable. 0 = Disable. Do NOT program to 0.</p>
1	<p>Instruction Parser Unit-Level Clock Gating Enable. This bit controls the unit-level clock gating in the Instruction Parser. This bit must be programmed to 1 for proper operation.</p> <p>1 = Enable. 0 = Disable. Do NOT program to 0.</p>
0	Reserved

3.4.21. BUFF_SC—System Memory Buffer Strength Control Register (Device 0)

Address Offset: 92–93h
 Default Value: FFFFh
 Access: Read/Write

This register programs the system memory DRAM interface signal buffer strengths. The programming of these bits should be based on DRAM density (x8, x16, or x32), DRAM technology (16Mb, 64Mb, 128Mb), rows populated, etc.. Note that x4 DRAM are not supported, even if registered DIMMs are used. DIMMs with ECC are also not supported and BIOS upon detection of ECC via SPD, should report to the user that ECC DIMM timings are not supported by the GMCH.

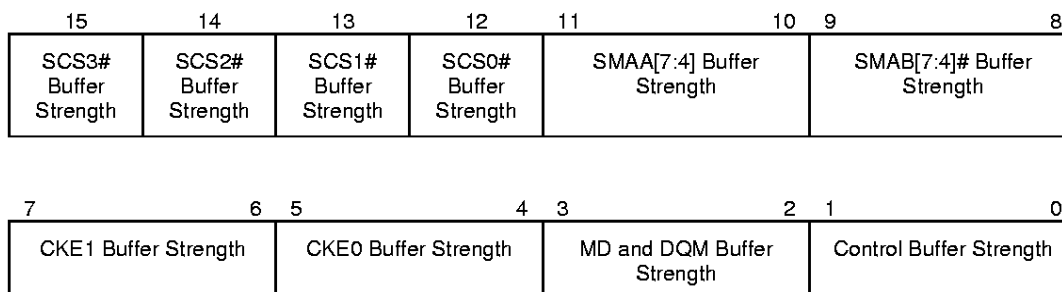

Bit	Description
15	SCS3# Buffer Strength. This field sets the buffer strength for system memory chip select SCS3#. 0 = 3x 1 = 2x
14	SCS2# Buffer Strength. This field sets the buffer strength for system memory chip select SCS2#. 0 = 3x 1 = 2x
13	SCS1# Buffer Strength. This field sets the buffer strength for system memory chip select SCS1#. 0 = 3x 1 = 2x
12	SCS0# Buffer Strength. This field sets the buffer strength for system memory chip select SCS0#. 0 = 3x 1 = 2x
11:10	SMAA[7:4] Buffer Strength. This field sets the buffer strength for the SMAA[7:4] buffers. 00 = 4x 01 = 3x 10 = 2x 11 = 1x

Bit	Description
9:8	<p>SMAB[7:4]# Buffer Strength. This field sets the buffer strength for the SMAB[7:4]# buffers.</p> <p>00 = 4x 01 = 3x 10 = 2x 11 = 1x</p>
7:6	<p>CKE1 Buffer Strength. This field sets the buffer strength for the CKE1 buffers.</p> <p>00 = 4x 01 = 3x 10 = 2x 11 = 1x</p>
5:4	<p>CKE0 Buffer Strength. This field sets the buffer strength for the CKE0 buffers.</p> <p>00 = 4x 01 = 3x 10 = 2x 11 = 1x</p>
3:2	<p>SMD[63:0] and SDQM[7:0] Buffer Strength. This field sets the buffer strength for the SMD[63:0] and SDQM[7:0] pins.</p> <p>00 = 2.5x 01 = 1.5x 10 = 1x 11 = 1x</p>
1:0	<p>SWE#, SCAS#, SRAS#, MAA[11:8, 3:0], SBS[1:0] Control Buffer Strength. This field sets the buffer strength for the SWE#, SCAS#, SRAS#, MAA[11:8, 3:0], SBS[1:0] pins.</p> <p>00 = 4x 01 = 3x 10 = 2x 11 = 1x</p>

3.5. Graphics Device Registers – (Device 1)

Table 5 shows the GMCH configuration space for device #1.

Table 5. GMCH Configuration Space (Device 1)

Address Offset	Register Symbol	Register Name	Default Value	Access
00–01h	VID1	Vendor Identification	8086h	RO
02–03h	DID1	Device Identification	7121h/7123h	RO
04–05h	PCICMD1	PCI Command Register	0004h	R/W
06–07h	PCISTS1	PCI Status Register	02B0h	RO, R/WC
08h	RID1	Revision Identification	02h	RO
09h	PI	Programming Interface	00h	RO
0Ah	SUBC1	Sub-Class Code	00h	RO
0Bh	BCC1	Base Class Code	03h	RO
0Ch	CLS	Cache Line Size Register	00h	RO
0Dh	MLT1	Master Latency Timer	00h	RO
0Eh	HDR1	Header Type	01h	RO
0Fh	BIST	BIST Register	00h	RO
10–13h	GMADR	Graphics Memory Range Address	00000008h	R/W
14–17h	MMADR	Memory Mapped Range Address	00000000h	R/W
18–2Bh	—	Reserved	—	—
2C–2Dh	SVID	Subsystem Vendor ID	0000h	R/WO
2E–2Fh	SID	Subsystem ID	0000h	R/WO
30–33h	ROMADR	Video Bios ROM Base Address	00000000h	RO
34	CAPPOINT	Capabilities Pointer	DCh	RO
35–3Bh	—	Reserved	—	—
3Ch	INTRLINE	Interrupt Line Register	00h	R/W
3Dh	INTRPIN	Interrupt Pin Register	01h	RO
3Eh	MINGNT	Minimum Grant Register	00h	RO
3Fh	MAXLAT	Maximum Latency Register	00h	RO
40–DBh	—	Reserved	—	—
DC–DDh	PM_CAPID	Power Management Capabilities ID	0001h	RO
DE–DFh	PM_CAP	Power Management Capabilities	0021h	RO
E0–E1h	PM_CS	Power Management Control	0000h	R/W
E2–FFh	—	Reserved	—	—

3.5.1. VID—Vendor Identification Register (Device 1)

Address Offset: 00h–01h
 Default Value: 8086h
 Attribute: Read Only

The VID Register contains the vendor identification number. This 16-bit register combined with the Device Identification Register uniquely identify any PCI device. Writes to this register have no effect.

Bit	Description
15:0	Vendor Identification Number. This is a 16-bit value assigned to Intel.

3.5.2. DID—Device Identification Register (Device 1)

Address Offset: 02h–03h
 Default Value: 82810 = 7121h
 82810-DC100 = 7123h
 Attribute: Read Only

This 16-bit register combined with the Vendor Identification register uniquely identifies any PCI device. Writes to this register have no effect.

Bit	Description
15:0	Device Identification Number. This is a 16 bit value assigned to the internal graphics device of the GMCH.

3.5.3. PCICMD—PCI Command Register (Device 1)

Address Offset: 04h–05h
 Default: 0004h
 Access: Read Only, Read/Write

This 16-bit register provides basic control over the GMCH’s ability to respond to PCI cycles. The PCICMD Register in the GMCH disables the GMCH PCI compliant master accesses to system memory.

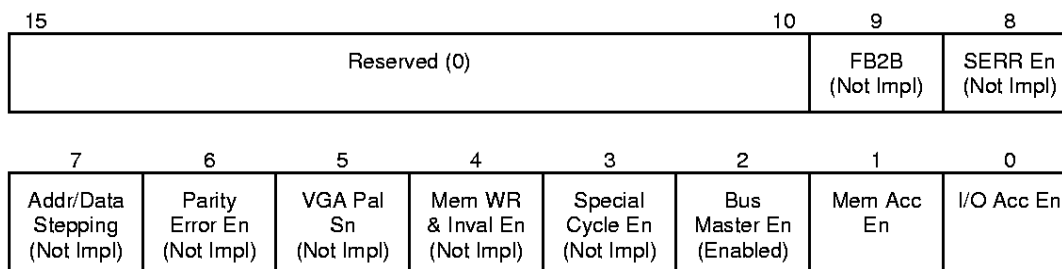

Bit	Descriptions
15:10	Reserved.
9	Fast Back-to-Back (FB2B)—RO. (Not Implemented). Hardwired to 0.
8	SERR# Enable (SERRE)—RO. (Not Implemented). Hardwired to 0.
7	Address/Data Stepping—RO. (Not Implemented). Hardwired to 0.
6	Parity Error Enable (PERRE)—RO. (Not Implemented). Hardwired to 0.
5	Video Palette Snooping (VPS)—RO. This bit is hardwired to 0 to disable snooping.
4	Memory Write and Invalidate Enable (MWIE)—RO. Hardwired to 0. The internal graphics device of the GMCH does not support memory write and invalidate commands.
3	Special Cycle Enable (SCE)—RO. This bit is hardwired to 0. The internal graphics device of the GMCH ignores Special cycles.
2	Bus Master Enable (BME)—RO. Hardwired to 1 to enable the internal graphics device of the GMCH to function as a PCI compliant master.
1	Memory Access Enable (MAE)—R/W. This bit controls the internal graphics device of the GMCH’s response to memory space accesses. 0 = Disable (default). 1 = Enable.
0	I/O Access Enable (IOAE)—R/W. This bit controls the internal graphics device of the GMCH’s response to I/O space accesses. 0 = Disable (default). 1 = Enable.

3.5.4. PCISTS—PCI Status Register (Device 1)

Address Offset: 06h–07h
 Default Value: 02B0h
 Access: Read Only

PCISTS is a 16-bit status register that reports the occurrence of a PCI compliant master abort and PCI compliant target abort. PCISTS also indicates the DEVSEL# timing that has been set by the GMCH hardware.

15	14	13	12	11	10	9	8					
Detected Par Error (HW=0)	Sig Sys Error (HW=0)	Recog Mast Abort Sta (HW=0)	Rec Target Abort Sta (HW=0)	Sig Target Abort Sta (HW=0)	DEVSEL# Timing (HW=01)		Data Par Detected (HW=0)					
							7	6	5	4	3	0
FB2B (HW=1)		Reserved		Reserved		Cap List (HW=1)		Reserved				

Bit	Descriptions
15	Detected Parity Error (DPE)—RO. Since the internal graphics device of the GMCH does not detect parity, this bit is always set to 0.
14	Signaled System Error (SSE)—RO. The internal graphics device of the GMCH device never asserts SERR#, therefore this bit is hardwired to 0.
13	Received Master Abort Status (RMAS)—RO. The internal graphics device of the GMCH device never gets a Master Abort, therefore this bit is hardwired to 0.
12	Received Target Abort Status (RTAS)—RO. The internal graphics device of the GMCH device never gets a Target Abort, therefore this bit is hardwired to 0.
11	Signaled Target Abort Status (STAS). Hardwired to 0. The internal graphics device of the GMCH does not use target abort semantics.
10:9	DEVSEL# Timing (DEVT)—RO. This 2-bit field indicates the timing of the DEVSEL# signal when the internal graphics device of the GMCH responds as a target. Hardwired to 01 to indicate that the internal graphics device of the GMCH is a medium decode device.
8	Data Parity Detected (DPD)—R/WC. Since Parity Error Response is hardwired to disabled (and the internal graphics device of the GMCH does not do any parity detection), this bit is hardwired to 0.
7	Fast Back-to-Back (FB2B). Hardwired to 1. The internal graphics device of the GMCH accepts fast back-to-back when the transactions are not to the same agent.
6:5	Reserved.
4	CAP LIST—RO. This bit is set to 1 to indicate that the register at 34h provides an offset into the function's PCI Configuration Space containing a pointer to the location of the first item in the list.
3:0	Reserved.

3.5.5. RID—Revision Identification Register (Device 1)

Address Offset: 08h
 Default Value: 02h
 Access: Read Only

This register contains the revision number of the internal graphics device of the GMCH. These bits are read only and writes to this register have no effect.

Bit	Description
7:0	Revision Identification Number. This is an 8-bit value that indicates the revision identification number for the internal graphics device of the GMCH. The four lsb's are for process differentiation and the four msbs indicate stepping. For the A-2 Stepping, this value is 02h

3.5.6. PI—Programming Interface Register (Device 1)

Address Offset: 09h
 Default Value: 00h
 Access: Read Only

This register contains the device programming interface information for the GMCH.

Bit	Description
7:0	Programming Interface (PI). 00h=Hardwired as a Display controller.

3.5.7. SUBC1—Sub-Class Code Register (Device 1)

Address Offset: 0Ah
 Default Value: 00h
 Access: Read Only
 Size: 8 bits

This register contains the Sub-Class Code for the GMCH Function #1. This code is 00h indicating a VGA compatible device. The register is read only.

Bit	Description
7:0	Sub-Class Code (SUBC). This is an 8-bit value that indicates the category of Display controller of the GMCH. The code is 00h indicating a VGA compatible device.

3.5.8. BCC1—Base Class Code Register (Device 1)

Address Offset: 0Bh
 Default Value: 03h
 Access: Read Only
 Size: 8 bits

This register contains the Base Class Code of the GMCH Function #1. This code is 03h indicating a Display controller. This register is read only.

Bit	Description
7:0	Base Class Code (BASEC). This is an 8-bit value that indicates the Base Class Code for the GMCH. This code has the value 03h, indicating a Display controller.

3.5.9. CLS—Cache Line Size Register (Device 1)

Address Offset: 0Ch
 Default Value: 00h
 Access: Read only

The internal graphics device of the GMCH does not support this register as a PCI slave.

Bit	Description
7:0	Cache Line Size (CLS). This field is hardwired to 0's. The internal graphics device of the GMCH as a PCI compliant master does not use the Memory Write and Invalidate command and, in general, does not perform operations based on cache line size.

3.5.10. MLT—Master Latency Timer Register (Device 1)

Address Offset: 0Dh
 Default Value: 00h
 Access: Read Only

The internal graphics device of the GMCH does not support the programmability of the master latency timer because it does not perform bursts.

Bit	Description
7:0	Master Latency Timer Count Value. Hardwired to 0s.

3.5.11. HDR—Header Type Register (Device 1)

Address Offset: 0Eh
 Default Value: 00h
 Access: Read Only

This register contains the Header Type of the internal graphics device of the GMCH.

Bit	Description
7:0	Header Type (HTYPE). This is an 8-bit value that indicates the Header Type for the internal graphics device of the GMCH. This code has the value 00h, indicating a basic (i.e., single function) configuration space format.

3.5.12. BIST—Built In Self Test (BIST) Register (Device 1)

Address Offset: 0Fh
 Default Value: 00h
 Access: Read Only

This register is used for control and status of Built In Self Test (BIST) for the internal graphics device of the GMCH.



Bit	Descriptions
7	BIST Supported. BIST is not supported. This bit is hardwired to 0.
6:0	Reserved.

3.5.13. GMADR—Graphics Memory Range Address Register (Device 1)

Address Offset: 10–13h
 Default Value: 00000008h
 Access: Read/Write, Read Only

This register requests allocation for the internal graphics device of the GMCH local memory. The allocation is for either 32 MB or 64 MB of memory space (selected by bit 0 of the Device 0 MISCC Register) and the base address is defined by bits [31:25,24].

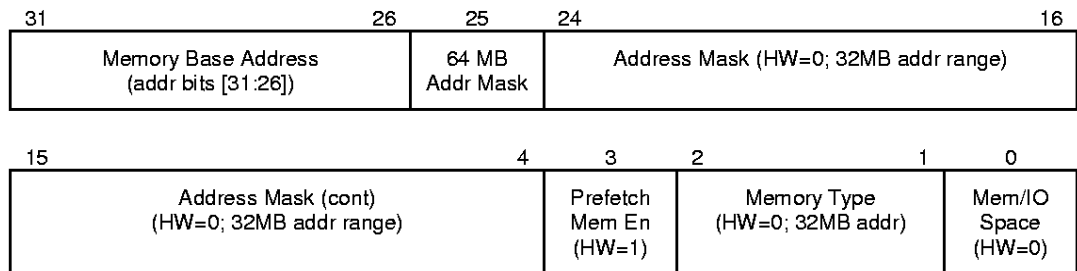

Bit	Descriptions
31:26	Memory Base Address—R/W. Set by the OS, these bits correspond to address signals [31:26].
25	64M Address Mask—RO , R/W. If Device 0 MISCC Reg bit 0 = 0 then this bit is Read Only with a value of "0", indicating a memory range of 64MB, if Device 0 MISCC Reg bit 0 = 1 then this bit is R/W, indicating a memory range of 32 MB.
24:4	Address Mask—RO. Hardwired to 0s to indicate 32 MB address range.
3	Prefetchable Memory—RO. Hardwired to 1 to enable prefetching.
2:1	Memory Type—RO. Hardwired to 0 to indicate 32-bit address.
0	Memory/IO Space—RO. Hardwired to 0 to indicate memory space.

3.5.14. MMADR—Memory Mapped Range Address Register (Device 1)

Address Offset: 14–17h
 Default Value: 00000000h
 Access: Read/Write, Read Only

This register requests allocation for the internal graphics device of the GMCH registers and instruction ports. The allocation is for 512 KB and the base address is defined by bits [31:19].

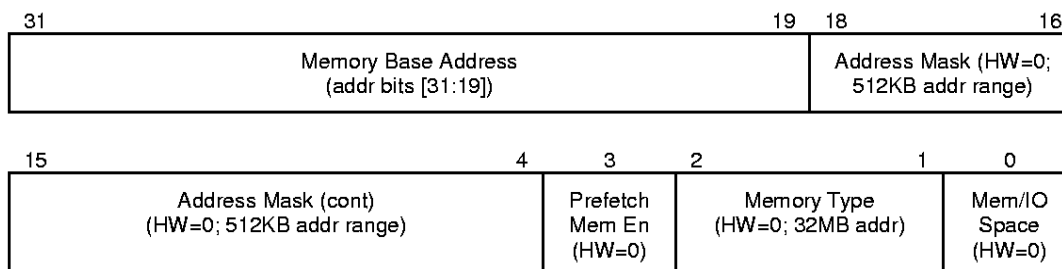

Bit	Descriptions
31:19	Memory Base Address—R/W. Set by the OS, these bits correspond to address signals [31:19].
18:4	Address Mask—RO. Hardwired to 0s to indicate 512 KB address range.
3	Prefetchable Memory—RO. Hardwired to 0 to prevent prefetching.
2:1	Memory Type—RO. Hardwired to 0s to indicate 32-bit address.
0	Memory / IO Space—RO. Hardwired to 0 to indicate memory space.

3.5.15. SVID—Subsystem Vendor Identification Register (Device 1)

Address Offset: 2C–2Dh
 Default Value: 0000h
 Access: Read/Write Once

Bit	Descriptions
15:0	Subsystem Vendor ID—R/WO. This value is used to identify the vendor of the subsystem. The default value is 0000h. This field should be programmed by BIOS during boot-up. Once written, this register becomes Read_Only. This Register can only be cleared by a Reset.

3.5.16. SID—Subsystem Identification Register (Device 1)

Address Offset: 2E–2Fh
 Default Value: 0000h
 Access: Read/Write Once

Bit	Descriptions
15:0	Subsystem ID—R/WO. This value is used to identify a particular subsystem. The default value is 0000h. This field should be programmed by BIOS during boot-up. Once written, this register becomes Read_Only. This Register can only be cleared by a Reset.

3.5.17. ROMADR—Video BIOS ROM Base Address Registers (Device 1)

Address Offset: 30–33h
 Default Value: 00000000h
 Access: Read Only

The internal graphics device of the GMCH does not use a separate BIOS ROM, therefore this is hardwired to 0s.

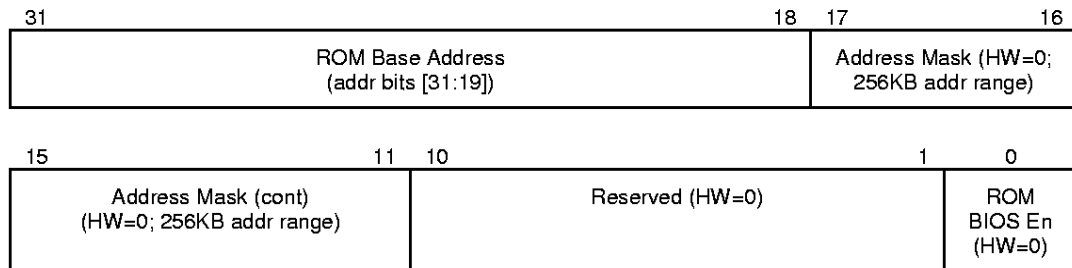

Bit	Descriptions
31:18	ROM Base Address—RO. Hardwired to 0s.
17:11	Address Mask—RO. Hardwired to 0s to indicate 256 KB address range.
10:1	Reserved. Hardwired to 0s.
0	ROM BIOS Enable—RO. 0 = ROM not accessible.

3.5.18. CAPPOINT—Capabilities Pointer Register (Device 1)

Address Offset: 34h
 Default Value: DCh
 Access: Read Only

Bit	Descriptions
7:0	Pointer to the Start of AGP Register Block. Since there is no AGP bus on the GMCH, this field is set to DCh to point to the Power Management Capabilities ID Register

3.5.19. INTRLINE—Interrupt Line Register (Device 1)

Address Offset: 3Ch
 Default Value: 00h
 Access: Read/Write

Bit	Descriptions
7:0	Interrupt Connection. Used to communicate interrupt line routing information. POST software writes the routing information into this register as it initializes and configures the system. The value in this register indicates which input of the system interrupt controller that the device's interrupt pin is connected to.

3.5.20. INTRPIN—Interrupt Pin Register (Device 1)

Address Offset: 3Dh
 Default Value: 01h
 Access: Read Only

Bit	Descriptions
7:0	Interrupt Pin. As a single function device, GMCH specifies INTA# as its interrupt pin. 01h=INTA#.

3.5.21. MINGNT—Minimum Grant Register (Device 1)

Address Offset: 3Eh
 Default Value: 00h
 Access: Read Only

Bit	Descriptions
7:0	Minimum Grant Value. GMCH does not burst as a PCI compliant master. Bits[7:0]=00h.

3.5.22. MAXLAT—Maximum Latency Register (Device 1)

Address Offset: 3Fh
 Default Value: 00h
 Access: Read Only

Bit	Descriptions
7:0	Maximum Latency Value. Bits[7:0]=00h. The GMCH has no specific requirements for how often it needs to access the PCI bus.

3.5.23. PM_CAPID—Power Management Capabilities ID Register (Device 1)

Address Offset: DCh–DDh
 Default Value: 0001h
 Access: Read Only

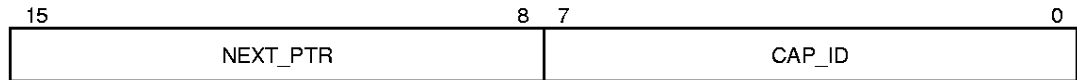

Bits	Description
15:8	NEXT_PTR. This contains a pointer to next item in capabilities list. This the final capability in the list and must be set to 00h.
7:0	CAP_ID. SIG defines this ID is 01h for power management.

3.5.24. PM_CAP—Power Management Capabilities Register (Device 1)

Address Offset: DEh–DFh
 Default Value: 0021h
 Access: Read Only

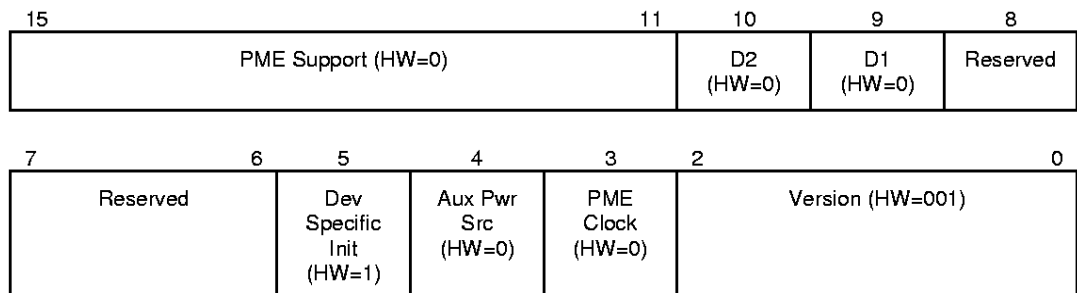

Bits	Description
15:11	PME Support. This field indicates the power states in which the GMCH may assert PME#. Hardwired to 0 to indicate that the GMCH does not assert the PME# signal.
10	D2. Hardwired to 0 to indicate D2 power management state is not supported.
9	D1. Hardwired to 0 to indicate that D1 power management state is not supported.
8:6	Reserved. Read as 0s.
5	Device Specific Initialization (DSI). Hardwired to 1 to indicate that special initialization of the GMCH is required before generic class device driver is to use it.
4	Auxiliary Power Source. Hardwired to 0.
3	PME Clock. Hardwired to 0 to indicate the GMCH does not support PME# generation.
2:0	Version. Hardwired to 001b to indicate there are 4 bytes of power management registers implemented.

3.5.25. PM_CS—Power Management Control/Status Register (Device 1)

Address Offset: E0h–E1h
 Default Value: 0000h
 Access: Read/Write

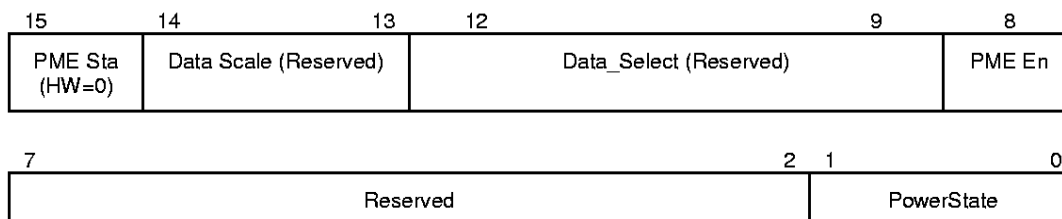

Bits	Description
15	PME_Status—R/WC. This bit is 0 to indicate that the GMCH does not support PME# generation from D3 (cold).
14:13	Data Scale (Reserved)—RO. The GMCH does not support data register. This bit always returns 0 when read, write operations have no effect.
12:9	Data_Select (Reserved)—RO. The GMCH does not support data register. This bit always returns 0 when read, write operations have no effect.
8	PME_En—R/W. This bit is 0 to indicate that PME# assertion from D3 (cold) is disabled.
7:2	Reserved. Always returns 0 when read, write operations have no effect.
1:0	PowerState—R/W. This field indicates the current power state of the GMCH and can be used to set the GMCH into a new power state. If software attempts to write an unsupported state to this field, write operation must complete normally on the bus, but the data is discarded and no state change occurs. 00 = D0 01 = Reserved 10 = Reserved 11 = D3

3.6. Display Cache Interface (82810-DC100 Only)

The Display Cache (DC) interface control registers are located in memory Space. This section describes the DC interface registers. These registers are accessed using [MMADR+Offset]. These registers are memory mapped only.

3.6.1. DRT—DRAM Row Type

Memory Offset Address : 3000h
 Default value : 00h
 Access : Read / write
 Size : 8 bit

This 8-bit register identifies whether or not the display cache is populated. Memory mapped only.

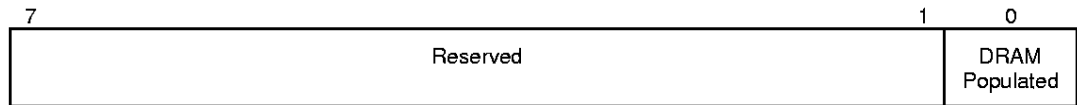

Bit	Description
7:1	Reserved
0	DRAM Populated (DP). The bit in this register indicates whether or not the Display Cache is populated. 0 = No Display Cache 1 = 4MB Display Cache

3.6.2. DRAMCL—DRAM Control Low

Memory Offset Address : 3001h
 Default value : 17h
 Access : Read / write
 Size : 8 bit

7	5	4	3	2	1	0
Reserved		Paging Mode Control	RAS-to- CAS Override	CAS# Latency	RAS# Riming	RAS# Precharge Timing

Bit	Description									
7:5	Reserved									
4	Paging Mode Control (PMC) 0 = Page Open Mode. In this mode the GMCH memory controller tends to leave pages open. 1 = Page Close Mode. In this mode the GMCH memory controller tends to leave pages closed.									
3	RAS-to-CAS Override (RCO) . In units of display cache clock periods indicates the RAS#-to-CAS# delay (t_{RCD}). (i.e., row activate command to read/write command) 0 = determined by CL bit (default) 1 = 2									
2	CAS# Latency (CL) . In units of local memory clock periods. <table border="1" style="margin-left: 20px;"> <thead> <tr> <th style="text-align: left;">Bit</th> <th style="text-align: left;">CL</th> <th style="text-align: left;">RAS#-to-CAS# delay (t_{RCD})</th> </tr> </thead> <tbody> <tr> <td>0</td> <td>2</td> <td>2</td> </tr> <tr> <td>1</td> <td>3</td> <td>3 (default)</td> </tr> </tbody> </table>	Bit	CL	RAS#-to-CAS# delay (t_{RCD})	0	2	2	1	3	3 (default)
Bit	CL	RAS#-to-CAS# delay (t_{RCD})								
0	2	2								
1	3	3 (default)								
1	RAS# Timing (RT) . This bit controls RAS# active to precharge, and refresh to RAS# active delay (in local memory clocks). <table border="1" style="margin-left: 20px;"> <thead> <tr> <th style="text-align: left;">Bit</th> <th style="text-align: left;">RAS# act. To precharge (t_{RAS})</th> <th style="text-align: left;">Refresh to RAS# act. (t_{RC})</th> </tr> </thead> <tbody> <tr> <td>0</td> <td>5</td> <td>8</td> </tr> <tr> <td>1</td> <td>7</td> <td>10 (default)</td> </tr> </tbody> </table>	Bit	RAS# act. To precharge (t_{RAS})	Refresh to RAS# act. (t_{RC})	0	5	8	1	7	10 (default)
Bit	RAS# act. To precharge (t_{RAS})	Refresh to RAS# act. (t_{RC})								
0	5	8								
1	7	10 (default)								
0	RAS# Precharge Timing (RPT) . This bit controls RAS# precharge (in local memory clocks). 0 = 2 1 = 3 (default)									

3.6.3. DRAMCH—DRAM Control High

Memory Offset Address : 3002h
 Default value : 08h
 Access : Read / write
 Size : 8 bit

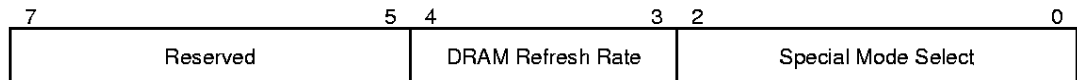

Bit	Description
7:5	Reserved
4:3	<p>DRAM Refresh Rate (DRR). DRAM refresh is controlled using this field. Disabling refresh results in the eventual loss of DRAM data, although refresh can be briefly disabled without data loss. The field must be set to normal refresh as soon as possible once DRAM testing is completed.</p> <p>00 = Refresh Disabled 01 = Refresh Enabled (default) 10 = Reserved 11 = Reserved</p>
2:0	<p>Special Mode Select (SMS). These bits select special SDRAM modes used for testing and initialization. The NOP command must be programmed first before any other command can be issued.</p> <p>000 = Normal SDRAM mode (Normal, default).</p> <p>001 = NOP Command Enable (NCE). This state forces cycles to DRAM to generate SDRAM NOP commands.</p> <p>010 = All Banks Precharge Command Enable (ABPCE). This state forces cycles to DRAM to generate an all banks precharge command.</p> <p>011 = Mode Register Command Enable (MRCE). This state forces all cycles to DRAM to be converted into MRS commands. The command is driven on the LMA[11:0] lines. LMA[2:0] correspond to the burst length, LMA[3] corresponds to the wrap type, and LMA[6:4] correspond to the latency mode. LMA[11:7] are driven to 00000 by the GMCH,</p> <p>The BIOS must select an appropriate host address for each row of memory such that the right commands are generated on the LMA[6:0] lines, taking into account the mapping of host addresses to display cache addresses.</p> <p>100 = CBR Cycle Enable (CBRCE). This state forces cycles to DRAM to generate SDRAM CBR refresh cycles.</p> <p>101 = Reserved.</p> <p>11X = Reserved.</p>

3.7. Display Cache Detect and Diagnostic Registers (82810-DC100 Only)

The following registers are used for display cache detection and diagnostics. These registers can be accessed via either I/O space or memory space. The memory space addresses listed are offsets from the base memory address programmed into the MMADR register (Device 1, PCI configuration offset 14h). For each register, the memory-mapped address offset is the same address value as the I/O address. See the Intel® 810 chipset BIOS specification for the proper setting of these registers for display cache detection and diagnostics.

3.7.1. GRX—GRX Graphics Controller Index Register

I/O (and Memory Offset) Address: 3CEh
 Default: 0Uh (U=Undefined)
 Attributes: Read/Write

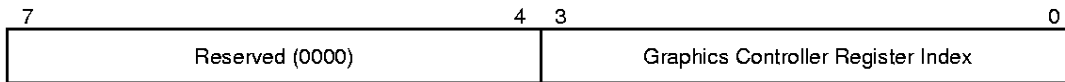

Bit	Description
7:4	Reserved. Read as 0s.
3:0	Sequencer Register Index. This field selects any one of the graphics controller registers (GR[00:08]) to be accessed via the data port at I/O location 3CFh.

3.7.2. MSR—Miscellaneous Output

I/O (and Memory Offset) Address: 3C2h — Write; 3CCh — Read
 Default: 00h
 Attributes: See Address above

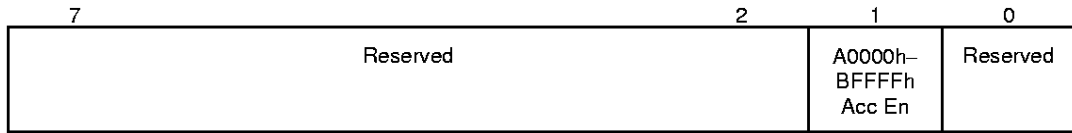

Bit	Descriptions
7:2	Reserved
1	<p>A0000–BFFFFh Access Enable. VGA Compatibility bit enables access to the display cache at A0000h–BFFFFh. When disabled, accesses to system memory are blocked in this region (by not asserting DEVSEL#). This bit does not block CPU access to the video linear frame buffer at other addresses.</p> <p>0 = Prevent CPU access to the display cache (default). 1 = Allow CPU access to display cache.</p>
0	Reserved

3.7.3. GR06—Miscellaneous Register

I/O (and Memory Offset) Address: 3CFh (Index=06h)
 Default: 0Uh (U=Undefined)
 Attributes: Read/Write

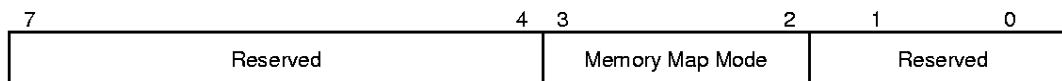

Bit	Description
7:4	Reserved
3:2	<p>Memory Map Mode. These 2 bits control the mapping of the VGA frame buffer into the CPU address space as follows:</p> <p>00 = A0000h – BFFFFh 01 = A0000h – AFFFFh 10 = B0000h – B7FFFh 11 = B8000h – BFFFFh</p> <p>Note: This function is both in standard VGA modes and in extended modes that do not provide linear frame buffer accesses.</p>
1:0	Reserved

3.7.4. GR10—Address Mapping

I/O (and Memory Offset) Address: 3CFh (Index=10h)
 Default: 00h
 Attributes: R/W

7	5	4	3	2	1	0
Reserved		Paging to display cache	VGA Buffer /Memory Map	Packed Mode Enbl	Linear Mapping	Page Mapping

Bit	Description
7:5	Reserved
4	Page to Display Cache Enable. 0 = Page to VGA Buffer. 1 = Page to Display Cache.
3	VGA Buffer/Memory Map Select. 0 = VGA Buffer (default) 1 = Memory Map.
2	Packed Mode Enable. 0 = Disable (default) 1 = Enable
1	Linear Mapping (PCI). 0 = Disable (default) 1 = Enable
0	Page Mapping Enable. This mode allows the mapping of the vga space allocated in main memory (non local video memory) mode or all of local memory space through the A000:AFFFF window which is a 64KB page. 0 = Disable (default) 1 = Enable

3.7.5. GR11—Page Selector

I/O (and Memory Offset) Address: 3CFh (Index=11h)
 Default : 00h
 Attributes: R/W

Bit	Description
7:0	Page Select. Selects a 64KB window within the display cache when Page Mapping is enabled to the display cache.

4. Functional Description

This chapter describes the Graphics and Memory Controller Hub (GMCH) interfaces on-chip functional units. Section 4.1, “System Address Map” provides a system-level address memory map and describes the memory space controls provided by the GMCH.

4.1. System Address Map

An Intel® Pentium III processor, Intel® Pentium II processor, or Intel® Celeron™ processor system based on the GMCH, supports 4 GB of addressable memory space and 64 KB+3 of addressable I/O space. (The P6 bus I/O addressability is 64KB + 3). There is a programmable memory address space under the 1 MB region which can be controlled with programmable attributes of Write Only, or Read Only. Attribute programming is described in the Configuration Register Description section. This section focuses on how the memory space is partitioned and what these separate memory regions are used for. The I/O address space is explained at the end of this section.

The Intel® Pentium III processor, Intel® Pentium II processor, and Intel® Celeron™ processor supports addressing of memory ranges larger than 4 GB. The GMCH Host Bridge claims any access over 4 GB by terminating transaction (without forwarding it to the hub interface). Writes are terminated by dropping the data and for reads the GMCH returns all zeros on the host bus.

In the following sections, it is assumed that all of the compatibility memory ranges reside on the hub interface. The exceptions to this rule are the VGA ranges which may be mapped to the internal Graphics Device.

Note: The GMCH Memory Map includes a number of programmable ranges, ALL of these ranges MUST be unique and NON-OVERLAPPING. There are NO Hardware Interlocks to prevent problems in the case of overlapping ranges. Accesses to overlapped ranges may produce indeterminate results.

4.1.1. Memory Address Ranges

Figure 4 shows a high-level representation of the system memory address map. Figure 5 provides additional details on mapping specific memory regions as defined and supported by the GMCH chipset.

Figure 4. System Memory Address Map

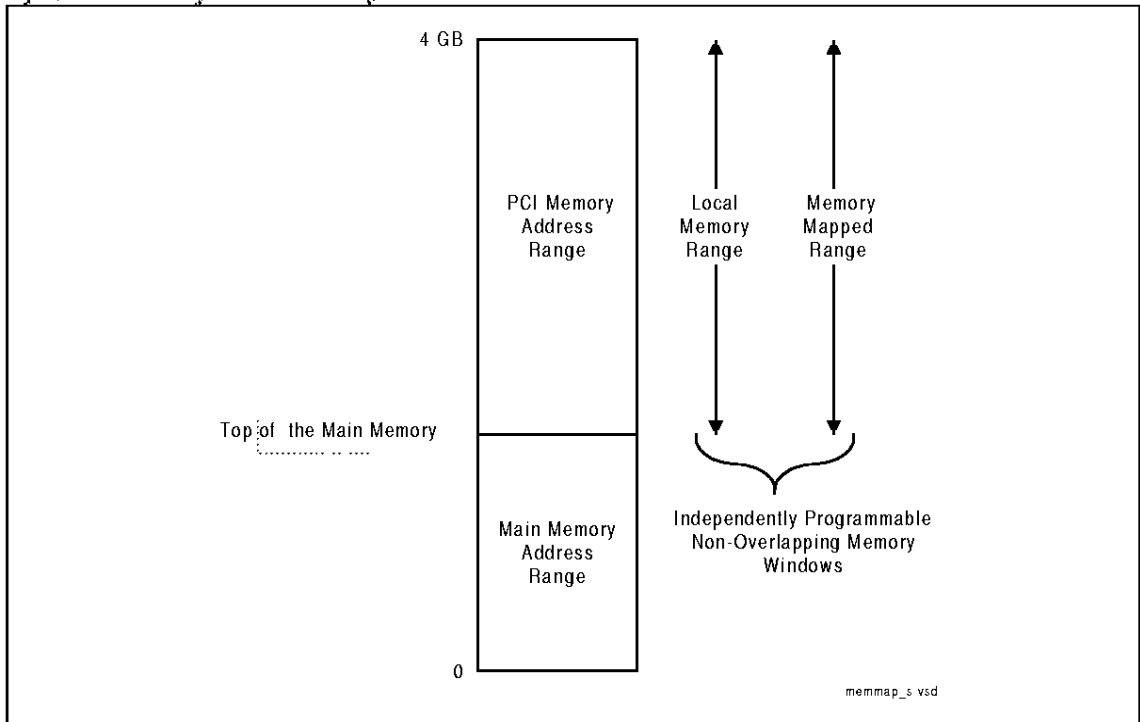
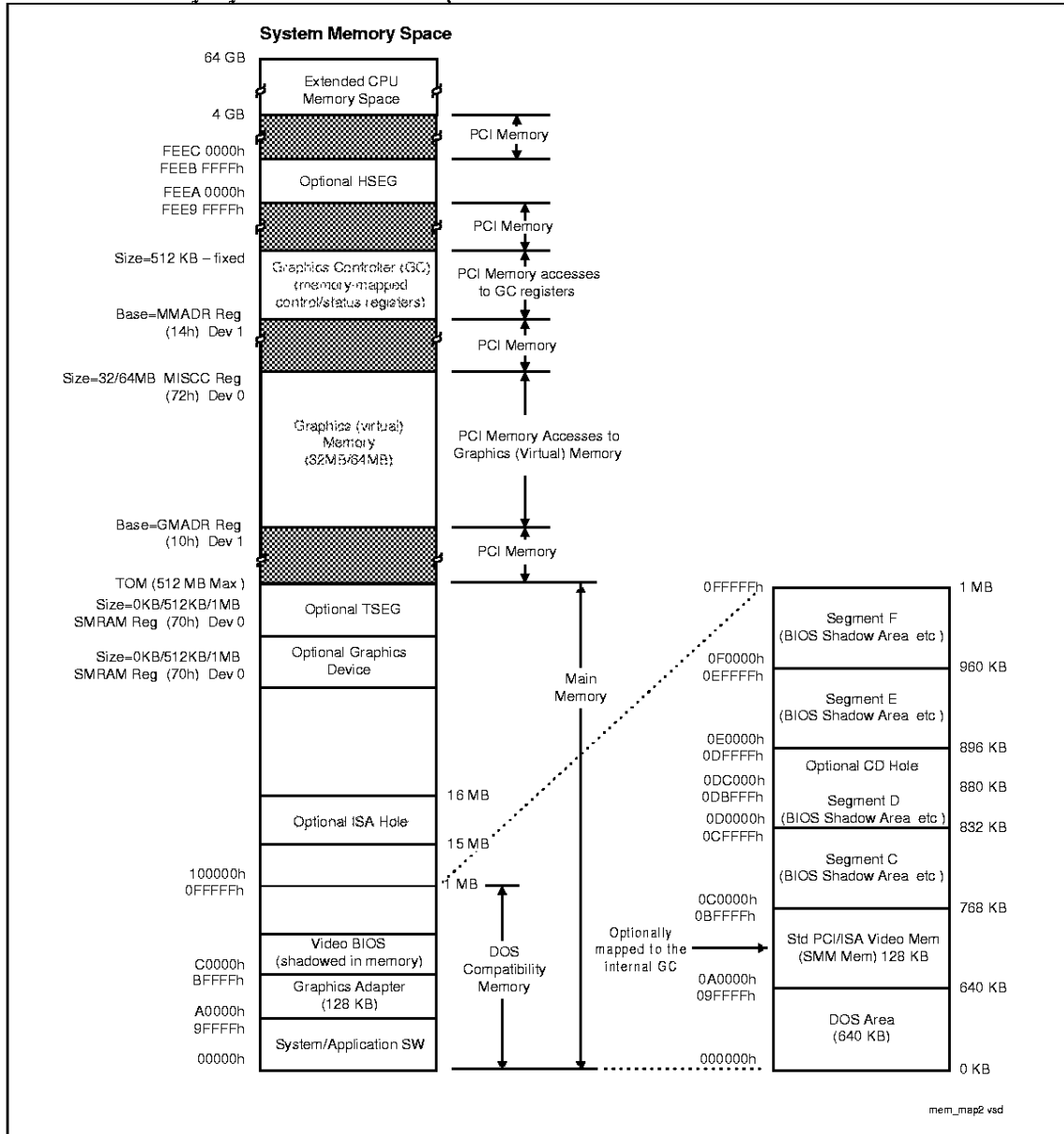

Figure 5. Detailed Memory System Address Map



4.1.1.1. Compatibility Area

This area is divided into the following address regions:

- 0–640 KB DOS Area
- 640–768 KB Video Buffer Area
- 768 KB–1 MB Memory (BIOS Area). System BIOS area, Extended System BIOS area, and Expansion area

Table 6 lists the memory segments of interest in the compatibility area. Four of the memory ranges can be enabled or disabled independently for both read and write cycles. One segment (0DC000h to 0DFFFFh) is conditionally mapped to the PCI Bus (via the hub interface).

Table 6. Memory Segments and their Attributes

Memory Segments	Attributes	Comments
000000h–09FFFFh	fixed - always mapped to main DRAM	0 to 640K - DOS Region
0A0000h–0BFFFFh	mapped to PCI - configurable as SMM space	Video Buffer (physical DRAM configurable as SMM space)
0C0000h–0CFFFFh	R/W, WO, RO, Disabled	BIOS etc Shadow Area
0D0000h–0DFFFFh	R/W, WO, RO, Disabled	BIOS etc Shadow Area
0DC000h–0DFFFFh	Included in above or Disabled	BIOS etc Shadow Area, Memory Hole
0E0000h–0EFFFFh	R/W, WO, RO, Disabled	BIOS etc Shadow Area
0F0000h–0FFFFFFh	R/W, WO, RO, Disabled	BIOS etc Shadow Area

- **DOS Area (00000h–9FFFFh).** The 640 KB DOS area is always mapped to the main memory controlled by the GMCH.
- **Video Buffer Area (A0000h–BFFFFh).** The 128 Kbyte graphics adapter memory region is normally mapped to a legacy video device (e.g., VGA controller) on PCI via the hub interface. This area is not controlled by the attribute bits and CPU-initiated cycles in this region are forwarded to hub interface or the internal graphics device for termination. This region is also the default region for SMM space.

Accesses to this range are directed to either PCI (via the hub interface) or the internal graphics device based on the configuration specified in SMRAM[GMS bits] (GMCH Device #0 configuration register) with additional steering information coming from the Device #1 configuration registers and from some of the VGA registers in the graphics device. The control is applied for accesses initiated from any of the system interfaces (i.e., host bus or hub interface). For more details see the descriptions in the configuration registers specified above.

SMRAM controls how SMM accesses to this space are treated.

- **Monochrome Adapter (MDA) Range (B0000h–B7FFFh).** SMRAM[GMS bits] (Device #0), PCICMD register bits of Device #1, and bits in some of the VGA registers control this functionality. (see Section 4.1.1.2).
- **CD Hole (DC000h–DFFFFh).** GMCHCFG[CDHEN] (Device 0) controls the routing of accesses in this region. When CDHEN = 1, all accesses to the address range 000DC000h–000DFFFFh are forwarded on to PCI, independent of the programming of the PAM register. When CDHEN = 0, the CD Hole region is controlled by bits [3:2] of the PAM Register.
- **BIOS etc Shadow Area (C0000h–FFFFFFh).** Except for the CD Hole area, access to this range is controlled by the bits of the PAMR register bits.

4.1.1.2. Extended Memory Area

This memory area covers the 100000h (1 MB) to FFFFFFFFh (4 GB-1) address range and it is divided into regions as specified in the following sections.

Main DRAM Address Region (0010_0000h to Top of Main Memory)

The address range from 1 MB to the top of main memory is mapped to main the DRAM address range controlled by the GMCH. All accesses to addresses within this range, except those listed below, are forwarded by the GMCH to DRAM.

- **Optional ISA Memory Hole (15 MB–16 MB).** A 1 MB ISA memory hole in the main DRAM range can be enabled via the FDHC register (Device 0). Note that this memory is not re-mapped. Accesses to this range are forwarded to PCI (via the hub interface)
- **TSEG.** This Extended SMRAM Address Range, if enabled, occupies the 512 KB or 1 MB range below the Top of Main Memory. The size of TSEG is determined by SMRAM[USMM] (Device 0). When the extended SMRAM space is enabled, non-SMM CPU accesses and all other accesses in this range are forwarded to PCI (via the hub interface). When SMM is enabled, the amount of memory available to the system is reduced by the TSEG range.
- **Optional Graphics Device Memory.** This address range provides either 512KB or 1MB of VGA buffer memory for the internal graphics device . If TSEG is enabled, this address range is just below TSEG. If TSEG is not enabled, the Optional Graphics Device VGA buffer range is just below TOM. The Graphics Device buffer memory range is enabled and the size selected via SMRAM[GMS].

PCI Memory Address Region (Top of Main Memory to 4 GB)

The address range from the top of main DRAM to 4 GB (top of physical memory space supported by the GMCH) is normally mapped to PCI (via the hub interface), except for the address ranges listed below.

There are two sub-ranges within the PCI Memory address range defined as APIC Configuration Space and High BIOS Address Range. The Local Memory Range and the Memory Mapped Range of the internal Graphics Device **MUST NOT** overlap with these two ranges.

- **GMCH's Graphics Controller Status/Control Register Range.** A 512 KB space for the graphics controller device's memory-mapped status/control registers that is requested during Plug and Play. The base address is programmed in the MMADR PCI Configuration Register for Device 1. Note that, for legacy support, the VGA registers in the GMCH's graphics controller are also mapped to the normal I/O locations.
- **Graphics Controller Graphics Memory Range.** The GMCH's graphics controller device uses a logical memory concept to access graphics memory. The logical graphics memory size is programmable as either 32 MB or 64 MB and is allocated by BIOS during Plug and Play. This address range is programmed in the GMADR Register (Device 1) and the MISCC Register (Device 0). The graphics controller engines can access this address space of which the lower 32 MB or all 64 MB correspond to graphics memory accessible by the CPU.

- **APIC Configuration Space (FEC0_0000h–FECF_FFFFh, FEE0_0000h–FEEF_FFFFh).** This range is reserved for APIC configuration space which includes the default I/O APIC configuration space. The default Local APIC configuration space is FEE0_0000h to FEEF_0FFFh.

CPU accesses to the Local APIC configuration space do not result in external bus activity since the Local APIC configuration space is internal to the CPU. However, a MTRR must be programmed to make the Local APIC range uncacheable (UC). The Local APIC base address in each CPU should be relocated to the FEC0_0000h (4GB–20MB) to FECF_FFFFh range so that one MTRR can be programmed to 64 KB for the Local and I/O APICs. The I/O APIC(s) usually reside in the I/O Bridge portion of the chipset or as a stand-alone component(s).

I/O APIC units will be located beginning at the default address FEC0_0000h. The first I/O APIC is located at FEC0_0000h. Each I/O APIC unit is located at FEC0_x000h where *x* is I/O APIC unit number 0 through F(hex). This address range will be normally mapped via hub interface to PCI.

The address range between the APIC configuration space and the High BIOS (FED0_0000h to FEDF_FFFFh) is always mapped to PCI (via the hub interface).

- **High BIOS Area (FFE0_0000h–FFFF_FFFFh).** The top 2 MB of the Extended Memory Region is reserved for System BIOS (High BIOS), extended BIOS for PCI devices, and the A20 alias of the system BIOS. CPU begins execution from the High BIOS after reset. This region is mapped to PCI (via the hub interface) so that the upper subset of this region aliases to 16 MB–256 KB range. The actual address space required for the BIOS is less than 2 MB but the minimum CPU MTRR range for this region is 2 MB so that full 2 MB must be considered. The ICH supports a maximum of 1MB in the High BIOS range.
- **Optional HSEG.** This Extended SMRAM Address Range, if enabled via the SMRAM register, occupies the range from FEEA_0000h to FEED_FFFFh. Maps to A0000h–BFFFFh when enabled.

4.1.1.3. System Management Mode (SMM) Memory Range

The GMCH supports the use of main memory as System Management RAM (SMRAM), enabling the use of System Management Mode. The GMCH supports two SMRAM options: Compatible SMRAM (C_SMRAM) and Extended SMRAM (E_SMRAM). System Management RAM (SMRAM) space provides a memory area that is available for the SMI handler's and code and data storage. This memory resource is normally hidden from the system OS so that the processor has immediate access to this memory space upon entry to SMM. The GMCH provides three SMRAM options:

- Below 1 MB option that supports compatible SMI handlers.
- Above 1 MB option that allows new SMI handlers to execute with write-back cacheable SMRAM.
- Optional larger write-back cacheable T_SEG area of either 512 KB or 1MB in size above 1 MB that is reserved from the highest area in system DRAM memory. The above 1 MB solutions require changes to compatible SMRAM handlers code to properly execute above 1 MB.

Refer to the Power Management section for more details on SMRAM support.

4.1.2. Memory Shadowing

Any block of memory that can be designated as read-only or write-only can be “shadowed” into the GMCH DRAM memory. Typically this is done to allow ROM code to execute more rapidly out of main DRAM. ROM is used as a read-only during the copy process while DRAM at the same time is designated write-only. After copying, the DRAM is designated read-only so that ROM is shadowed. CPU bus transactions are routed accordingly.

4.1.3. I/O Address Space

The GMCH does not support the existence of any other I/O devices besides itself on the CPU bus. The GMCH generates hub interface bus cycles for all CPU I/O accesses that do not target the Legacy I/O registers supported by the internal Graphics Device. The GMCH contains two internal registers in the CPU I/O space, Configuration Address Register (CONFIG_ADDRESS) and the Configuration Data Register (CONFIG_DATA). These locations are used to implement PCI configuration space access mechanism as described in the *Registers* section of this document.

The CPU allows 64K+3 bytes to be addressed within the I/O space. The GMCH propagates the CPU I/O address without any translation to the destination bus and therefore provides addressability for 64K+3 byte locations. Note that the upper 3 locations can be accessed only during I/O address wrap-around when CPU bus A16# address signal is asserted. A16# is asserted on the CPU bus whenever an I/O access is made to 4 bytes from address 0FFFDh, 0FFFEh, or 0FFFFh. A16# is also asserted when an I/O access is made to 2 bytes from address 0FFFFh.

The I/O accesses, other than ones used for PCI configuration space access or ones that target the internal Graphics Device are forwarded to hub interface. The GMCH will not post I/O write cycles to IDE.

The GMCH does not respond to I/O cycles initiated on hub interface.

4.1.4. GMCH Decode Rules and Cross-Bridge Address Mapping

The GMCH's address map applies globally to accesses arriving on any of the three interfaces (i.e., Host bus, hub interface or from the internal Graphics Device).

Hub Interface Decode Rules

The GMCH accepts all memory Read and Write accesses from hub interface to both System Memory and Graphics Memory. Hub interface accesses that fall elsewhere within the PCI memory range will not be accepted. The GMCH does not respond to hub interface-initiated I/O read or write cycles.

Legacy VGA Ranges

The legacy VGA memory range A0000h–BFFFFh is mapped either to the internal graphics device or to hub interface depending on the programming of the GMS bits in the SMRAM configuration register in GMCH Device #0, and some of the bits in the VGA registers of the internal Graphics Device. These same bits control mapping of VGA I/O address ranges. VGA I/O range is defined as addresses where A[9:0] are in the ranges 3B0h to 3BBh and 3C0h to 3DFh (inclusive of ISA address aliases - A[15:10] are not decoded). These bits control all accesses to the VGA ranges, including support for MDA functionality.

I/O accesses to location 3BFh are always forwarded on to hub interface.

4.2. Host Interface

The host interface of the GMCH is optimized to support the Intel® Pentium III processor, Intel® Pentium II processor, and Intel® Celeron™ processor. The GMCH implements the host address, control, and data bus interfaces within a single device. The GMCH supports a 4-deep in-order queue (i.e., supports pipelining of up to 4 outstanding transaction requests on the host bus) . Host bus addresses are decoded by the GMCH for accesses to system memory, PCI memory & PCI I/O (via hub interface), PCI configuration space and Graphics memory. The GMCH takes advantage of the pipelined addressing capability of the processor to improve the overall system performance. The GMCH supports the 370-pin socket and SC242 processor connectors.

4.2.1. Host Bus Device Support

The GMCH recognizes and supports a large subset of the transaction types that are defined for the Intel® Pentium III processor, Intel® Pentium II processor, or Intel® Celeron™ processor bus interface. However, each of these transaction types have a multitude of response types, some of which are not supported by this controller. All transactions are processed in the order that they are received on the processor bus.

Table 7. Summary of Transactions Supported By GMCH

Transaction	REQa[4:0]#	REQb[4:0]#	GMCH Support
Deferred Reply	0 0 0 0 0	X X X X X	The GMCH will initiate a deferred reply for a previously deferred transaction.
Reserved	0 0 0 0 1	X X X X X	Reserved
Interrupt Acknowledge	0 1 0 0 0	0 0 0 0 0	Interrupt acknowledge cycles are forwarded to the hub interface.
Special Transactions	0 1 0 0 0	0 0 0 0 1	See separate table in special cycles section.
Reserved	0 1 0 0 0	0 0 0 1 x	Reserved
Reserved	0 1 0 0 0	0 0 1 x x	Reserved
Branch Trace Message	0 1 0 0 1	0 0 0 0 0	The GMCH will terminate a branch trace message without latching data.
Reserved	0 1 0 0 1	0 0 0 0 1	Reserved
Reserved	0 1 0 0 1	0 0 0 1 x	Reserved
Reserved	0 1 0 0 1	0 0 1 x x	Reserved
I/O Read	1 0 0 0 0	0 0 x LEN#	I/O read cycles are forwarded to hub interface. I/O cycles which are in the GMCH configuration space will not be forwarded to the hub interface.
I/O Write	1 0 0 0 1	0 0 x LEN#	I/O write cycles are forwarded to hub interface. I/O cycles which are in the GMCH configuration space will not be forwarded to hub interface.
Reserved	1 1 0 0 x	0 0 x x x	Reserved
Memory Read & Invalidate	0 0 0 1 0	0 0 x LEN#	Host initiated memory read cycles are forwarded to DRAM or the hub interface.
Reserved	0 0 0 1 1	0 0 x LEN#	Reserved
Memory Code Read	0 0 1 0 0	0 0 x LEN#	Memory code read cycles are forwarded to DRAM or hub interface.
Memory Data Read	0 0 1 1 0	0 0 x LEN#	Host initiated memory read cycles are forwarded to DRAM or the hub interface.
Memory Write (no retry)	0 0 1 0 1	0 0 x LEN#	This memory write is a writeback cycle and cannot be retried. The GMCH will forward the write to DRAM.
Memory Write (can be retried)	0 0 1 1 1	0 0 x LEN#	The standard memory write cycle will be forwarded to DRAM or hub interface.

NOTES:

- For Memory cycles, REQa[4:3]# = ASZ#. GMCH only supports ASZ# = 00 (32 bit address).
- REQb[4:3]# = DSZ#. DSZ# = 00 (64 bit data bus size).
- LEN# = data transfer length as follows:

LEN#	Data length
00	<= 8 bytes (BE[7:0]# specify granularity)
01	Length = 16 bytes BE[7:0]# all active
10	Length = 32 bytes BE[7:0]# all active
11	Reserved

Table 8. Host Responses Supported by the GMCH

RS2#	RS1#	RS0#	Description	GMCH Support
0	0	0	idle	
0	0	1	Retry Response	This response is generated if an access is to a resource that cannot be accessed by the processor at this time and the logic must avoid deadlock . Hub interface directed reads, writes, and DRAM locked reads can be retried.
0	1	0	Deferred Response	This response can be returned for all transactions that can be executed 'out of order.' Hub interface directed reads (memory, I/O and Interrupt Acknowledge) and writes (I/O only), and internal Graphics device directed reads (memory and I/O) and writes (I/O only) can be deferred.
0	1	1	Reserved	Reserved
1	0	0	Hard Failure	Not supported.
1	0	1	No Data Response	This is for transactions where the data has already been transferred or for transactions where no data is transferred. Writes and zero length reads receive this response.
1	1	0	Implicit Writeback	This response is given for those transactions where the initial transactions snoop hits on a modified cache line.
1	1	1	Normal Data Response	This response is for transactions where data accompanies the response phase. Reads receive this response.

4.2.2. Special Cycles

A Special Cycle is defined when $REQa[4:0] = 01000$ and $REQb[4:0] = xx001$. The first address phase $Aa[35:3]\#$ is undefined and can be driven to any value. The second address phase, $Ab[15:8]\#$ defines the type of Special Cycle issued by the processor.

Table 9 specifies the cycle type and definition as well as the action taken by the GMCH when the corresponding cycles are identified.

Table 9. Special Cycles

$BE[7:0]\#$	Special Cycle Type	Action Taken
0000 0000	NOP	This transaction has no side-effects.
0000 0001	Shutdown	This transaction is issued when an agent detects a severe software error that prevents further processing. This cycle is claimed by the GMCH. The GMCH issues a shutdown special cycle on the hub interface. This cycle is retired on the CPU bus after it is terminated on the hub interface via a master abort mechanism.
0000 0010	Flush	This transaction is issued when an agent has invalidated its internal caches without writing back any modified lines. The GMCH claims this cycle and retires it.
0000 0011	Halt	This transaction is issued when an agent executes a HLT instruction and stops program execution. This cycle is claimed by the GMCH and propagated to the hub interface as a Special Halt Cycle. This cycle is retired on the CPU bus after it is terminated on the hub interface via a master abort mechanism.
0000 0100	Sync	This transaction is issued when an agent has written back all modified lines and has invalidated its internal caches. The GMCH claims this cycle and retires it.
0000 0101	Flush Acknowledge	This transaction is issued when an agent has completed a cache sync and flush operation in response to an earlier $FLUSH\#$ signal assertion. The GMCH claims this cycle and retires it.
0000 0110	Stop Clock Acknowledge	This transaction is issued when an agent enters Stop Clock mode. This cycle is claimed by the GMCH and propagated to the hub interface as a Special Stop Grant Cycle. This cycle is completed on the CPU bus after it is terminated on the hub interface via a master abort mechanism.
0000 0111	SMI Acknowledge	This transaction is first issued when an agent enters the System Management Mode (SMM). $Ab[7]\#$ is also set at this entry point. All subsequent transactions from the CPU with $Ab[7]\#$ set are treated by the GMCH as accesses to the SMM space. No corresponding cycle is propagated to the hub interface. To exit the System Management Mode the CPU issues another one of these cycles with the $Ab[7]\#$ bit deasserted. The SMM space access is closed by the GMCH at this point.
all others	Reserved	

4.3. System Memory DRAM Interface

The GMCH integrates a system DRAM controller that supports a 64-bit DRAM array. The DRAM type supported is Synchronous (SDRAM). The GMCH generates the SCS#, SDQM, SCAS#, SRAS#, SWE# and multiplexed addresses, SMA for the DRAM array. The GMCH's DRAM interface operates at a clock frequency of 100 MHz, independent of the system bus interface clock frequency. The DRAM controller interface is fully configurable through a set of control registers. Complete descriptions of these registers are given in the register description section of this document.

The GMCH supports industry standard 64-bit wide DIMM modules with SDRAM devices. The 2 bank select lines SBS[1:0], the 12 Address lines SMAA[11:0], and second copies of 4 Address lines SMAB[7:4]# allow the GMCH to support 64 bit wide DIMMs using 16Mb, 64Mb, or 128Mb technology SDRAMs. The GMCH has four SCS# lines, enabling the support of up to four 64-bit rows of DRAM. For write operations of less than a Qword in size, the GMCH will perform a byte-wise write. The GMCH targets SDRAM with CL2 and CL3 and supports both single and double-sided DIMMs. The GMCH provides refresh functionality with programmable rate (normal DRAM rate is 1 refresh/15.6 μ s). The GMCH can be configured via the Page Closing Policy Bit in the GMCH Configuration Register to keep multiple pages open within the memory array. Pages can be kept open in any one row of memory. Up to 4 pages can be kept open within that row (The GMCH only supports 4 Bank SDRAMs on system DRAM interface).

4.3.1. DRAM Organization and Configuration

The GMCH supports 64-bit DRAM configurations. In the following discussion the term row refers to a set of memory devices that are simultaneously selected by a SCS# signal. The GMCH will support a maximum of 4 rows of memory. Both single-sided and double-sided DIMMs are supported.

The interface consists of the following pins:

Multiple copies: SMAA[7:4], SMAB[7:4]#

Single Copies: SMD[63:0]
SDQM[7:0]
SMAA[11:8,3:0]
SBS[1:0]
SCS[3:0]#
SCAS#
SRAS#
SWE#
SCKE[1:0]

The GMCH supports DIMMs populated with 8, 16, and 32 bit wide SDRAM devices. Registered DIMMs or DIMMs populated with 4 bit wide SDRAM devices are not supported. The GMCH supports 3.3v standard SDRAMs.

Table 10 illustrates a sample of the possible DIMM socket configurations along with corresponding DRP programming. See the register section of this document for a complete DRP programming table.

Table 10. Sample Of Possible Mix And Match Options For 4 Row/2 DIMM Configurations

DIMM0	DIMM1	DRP	Total Memory
0	4x(4M x 16) S	70	32 MB
4x (4M x16) S	0	07	32 MB
4x(4Mx16) + 2x(2Mx32) D	0	08	48 MB
4x(4Mx16) S	4x(4Mx16) S	77	64 MB
8x(8Mx8) + 4x(4Mx16) D	0	0B	96 MB
8x(8Mx8) D	0	0C	128 MB
8x(8Mx8) D	8x(8Mx8) D	CC	256MB

NOTES:

1. "S" denotes single-sided DIMM's, "D" denotes double-sided DIMM's.

4.3.1.1. Configuration Mechanism For DIMMs

Detection of the type of DRAM installed on the DIMM is supported via Serial Presence Detect mechanism as defined in the JEDEC 168-pin DIMM standard. This standard uses the SCL, SDA and SA[2:0] pins on the DIMMs to detect the type and size of the installed DIMMs. No special programmable modes are provided on the GMCH for detecting the size and type of memory installed. Type and size detection must be done via the serial presence detection pins. Use of Serial Presence Detection is required.

Memory Detection and Initialization

Before any cycles to the memory interface can be supported, the GMCH DRAM registers must be initialized. The GMCH must be configured for operation with the installed memory types. Detection of memory type and size is done via the System Management Bus (SMBus) interface on the ICH. This two wire bus is used to extract the DRAM type and size information from the serial presence detect port on the DRAM DIMM modules.

DRAM DIMM modules contain a 5 pin serial presence detect interface, including SCL (serial clock), SDA (serial data) and SA[2:0]. Devices on the SMBus bus have a seven bit address. For the DRAM DIMM modules, the upper four bits are fixed at 1010. The lower three bits are strapped on the SA[2:0] pins. SCL and SDA are connected directly to the System Management Bus on the ICH. Thus data is read from the Serial Presence Detect port on the DRAM DIMM modules via a series of IO cycles to the ICH. BIOS essentially needs to determine the size and type of memory used for each of the four rows of memory in order to properly configure the GMCH system memory interface.

SMBus Configuration and Access of the Serial Presence Detect Ports

For more details on this see the *Intel® 82801AA (ICH) and Intel® 82801AB (ICH0) I/O Controller Hub* datasheet.

4.3.1.2. DRAM Register Programming

This section provides an overview of how the required information for programming the DRAM registers is obtained from the Serial Presence Detect ports on the DIMMs. The Serial Presence Detect ports are used to determine Refresh Rate, MA and MD Buffer Strength, Row Type (on a row by row basis), SDRAM Timings, Row Sizes and Row Page Sizes. Table 11 lists a subset of the data available through the on-board Serial Presence Detect ROM on each DIMM module.

Table 11. Data Bytes on DIMM Used for Programming DRAM Registers

Byte	Function
2	Memory Type (EDO, SDRAM) the GMCH only supports SDRAM.
3	# of Row Addresses, not counting Bank Addresses
4	# of Column Addresses
5	# of banks of DRAM (Single or Double sided) DIMM
12	Refresh Rate
17	# Banks on each SDRAM Device
36-41	Access Time from Clock for CAS# Latency 1 through 7
42	Data Width of SDRAM Components

Table 11 is only a subset of the defined SPD bytes on the DIMM module. These bytes collectively provide enough data for BIOS to program the GMCH DRAM registers.

4.3.2. DRAM Address Translation and Decoding

The GMCH contains address decoders that translate the address received on the host bus, hub interface, or from the internal Graphics device to an effective memory address. The GMCH supports 16 and 64 Mbit SDRAM devices. The GMCH supports a 2 KB page sizes only. The multiplexed row / column address to the DRAM memory array is provided by the SBS[1:0] and SMAA[1:0] signals and copies. These addresses are derived from the host address bus as defined by the following table for SDRAM devices.

Row size is internally computed using the values programmed in the DRP register.

Up to 4 pages can be open at any time within any row (Only 2 active pages are supported in rows populated with either 8 MBs or 16 MBs).

Table 12. GMCH DRAM Address Mux Function

Tech	Depth	Wid	Address Usage			Mem	BS		SMAA											
			Row	Col	Bk	Size	1	0	11	10	9	8	7	6	5	4	3	2	1	0
16Mb	1MB	16	11	8	1	8MB	X	11	X	[A]	22	21	20	19	18	17	16	15	14	13
							X	11	X	PA	X	X	10	9	8	7	6	5	4	3
16Mb	2MB	8	11	9	1	16MB	X	11	X	[A]	22	21	20	19	18	17	16	15	14	13
							X	11	X	PA	X	23	10	9	8	7	6	5	4	3
64Mb	2MB	32	11	8	2	16MB	12	11	X	[A]	22	21	20	19	18	17	16	15	14	13
							12	11	X	PA	X	X	10	9	8	7	6	5	4	3
64Mb	4MB	16	12	8	2	32MB	12	11	24	[A]	22	21	20	19	18	17	16	15	14	13
							12	11	X	PA	X	X	10	9	8	7	6	5	4	3
64Mb	8MB	8	12	9	2	64MB	12	11	24	[A]	22	21	20	19	18	17	16	15	14	13
							12	11	X	PA	X	25	10	9	8	7	6	5	4	3
128Mb	4MB	32	12	8	2	32MB	12	11	24	[A]	22	21	20	19	18	17	16	15	14	13
							12	11	X	PA	X	X	10	9	8	7	6	5	4	3
128Mb	8MB	16	12	9	2	64MB	12	11	24	[A]	22	21	20	19	18	17	16	15	14	13
							12	11	X	PA	X	25	10	9	8	7	6	5	4	3
128Mb	16MB	8	12	10	2	128MB	12	11	24	[A]	22	21	20	19	18	17	16	15	14	13
							12	11	X	PA	26	25	10	9	8	7	6	5	4	3

NOTES:

- [A]; MA bit 10 at RAS time uses the XOR of Address bit 12 and Address bit 23

4.3.3. DRAM Array Connectivity

Figure 6. DRAM Array Sockets

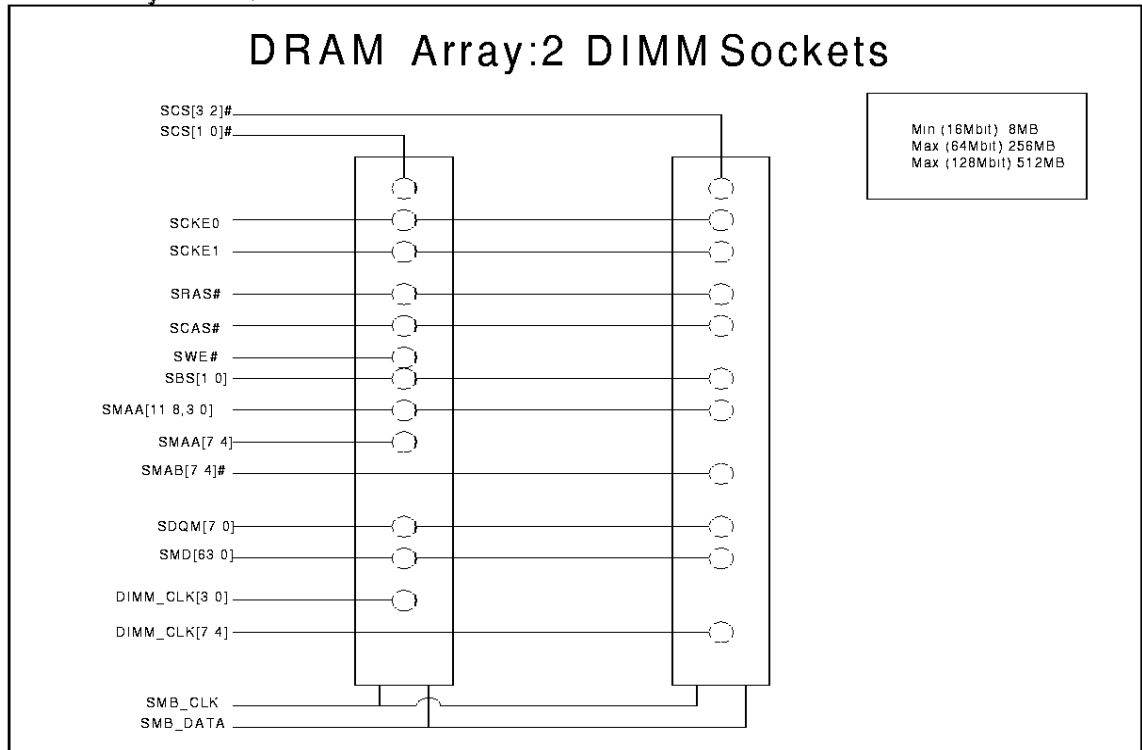

4.3.4. SDRAMT Register Programming

Several DRAM timing parameters are programmable in the GMCH configuration registers. Table 13 summarizes the programmable parameters.

Table 13. Programmable SDRAM Timing Parameters

Parameter	DRAMT Bit	Values (SCLKs)
RAS# Precharge (SRP)	0	2,3
RAS# to CAS# Delay (SRCD)	1	2,3
CAS# Latency (CL)	2	2,3
DRAM Cycle Time (DCT)	4	Tras = 5,6 Trc = 7,8

These parameters are controlled via the DRAMT register. To support different device speed grades CAS# Latency, RAS# to CAS# Delay and RAS# Precharge are all programmable as either two or three SCLKs. To provide flexibility, these are each controlled by separate register bits. That is, the GMCH can support any combination of CAS# Latency, RAS# to CAS# Delay and RAS# Precharge. One additional bit is provided for controlling SCS# assertion. In the fastest timing mode, SCS# can be asserted at the same time that address and command are asserted.

4.3.5. SDRAM Paging Policy

The GMCH can maintain up to 4 active pages in any one row; however, the GMCH does not support active pages in more than 1 row at a time.

The DRAM page closing policy (DPCP) in the GMCH configuration register (GMCHCFG) controls the page closing policy of the GMCH. This bit controls whether the GMCH will precharge bank or precharge all during the service of a page miss. When this bit is set to 0, the GMCH will precharge bank during the service of a page miss. When this bit is set to 1, the GMCH will precharge all during the service of a page miss.

4.4. Intel® Dynamic Video Memory Technology (D.V.M.)

The internal graphics device on both the 82810 and 82810-DC100 support Intel® Dynamic Video Memory Technology (D.V.M.). With D.V.M., the allocated size of system memory used for display graphics can be dynamically altered. For example, if 2 MB of system memory is needed, the driver allocates this amount. If later, only 1.5 MB is needed, the driver allocates the 1.5 MB size freeing up the remaining 512 KB for system use.

In addition to D.V.M., the 82810-DC100 supports Display Cache (DC). The graphics engine of the 82810-DC100 uses DC for implementing rendering buffers (e.g., Z buffers). This rendering model requires 4 MB of display cache and allows graphics rendering (performed across the graphics display cache bus) and texture MIP map access (performed across the system memory bus) simultaneously. Using D.V.M. all graphics rendering is implemented in system memory. The system memory bus is arbitrated between texture MIP-map accesses and rendering functions.

4.5. Display Cache Interface (82810-DC100 Only)

The GMCH Display Cache (DC) is a single channel 32 bit wide SDRAM interface. The DC handles the control and timing for the display cache. The display cache interface of the GMCH generates the LCS#, LDQM[7:0], LSCAS#, LSRAS#, LWE#, LMD[31:0] and multiplexed addresses, LMA[11:0] for the display cache DRAM array. The GMCH also generates the clock LTCLK for write cycles as well as LOCLK for read cycle timings.

The display cache interface of the GMCH supports single data rate synchronous dynamic random access memory (SDRAM). It supports a single 32-bit wide memory channel. The interface handles the operation of D.V.M. with DC at 100 MHz. The DRAM controller interface is fully configurable through a set of control registers.

Internal buffering (FIFOs) of the data to and from the display cache ensures the synchronization of the data to the internal pipelines. The D.V.M. with DC interface clocking is divided synchronous with respect to the core and system bus

4.5.1. Supported DRAM Types

Only 1Mx16 SDRAMs are supported by the GMCH.

4.5.2. Memory Configurations

Table 14 gives a summary of the characteristics of memory configurations supported. The GMCH supports a 32-bit wide channel populated with a single row of 1Mx16 SDRAMs.

Table 14. Memory Size for each configuration :

SDRAM	SDRAM	SDRAM	# of	Address Size			DRAM	DRAM Size
Tech.	Density	Width	Banks	Bank	Row	Column	Addressing	
16 Mbit	1M	16	2	1	11	8	Asymmetric	4MB

Figure 7 shows the GMCH LMI connected to 4 MB of memory in a 32-bit SDRAM channel configuration.

Figure 7. GMCH Display Cache Interface to 4MB

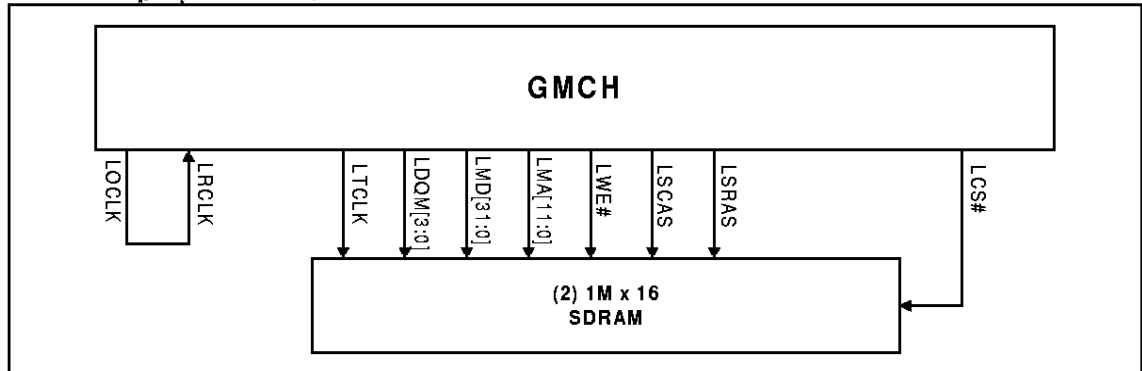

4.5.3. Address Translation

The GMCH contains address decoders that translate the address received by the display cache into an effective display cache address. The LMA[11:0] bits are as defined below. Entries in the table (e.g., A21(X)) imply that the GMCH puts out A21 on that MA line but it is not used by the SDRAM.

GMCH Local Memory Address Mapping		
MA	1Mx16	
	Row	Column
11(BA)	A10	A10
10	A11	X
9	A21	X
8	A20	X
7	A19	A9
6	A18	A8
5	A17	A7
4	A16	A6
3	A15	A5
2	A14	A4
1	A13	A3
0	A12	A2

BA = Bank address

4.5.4. Display Cache Interface Timing

The GMCH provides a variety of programmable wait states for DRAM read and write cycles. These options are programmed in the display cache I/O addresses of the GMCH configuration space. The wrap type and the burst length is implied since they are not programmable and fixed. Only sequential wrap is allowed. Burst length is fixed at two.

4.6. Internal Graphics Device

4.6.1. 3D/2D Instruction Processing

The GMCH contains an extensive set of instructions that control various functions including 3D rendering, BLT and STRBLT operations, display, motion compensation, and overlay. The 3D instructions set 3D pipeline states and control the processing functions. The 2D instructions provide an efficient method for invoking BLT and STRBLT operations.

The graphics controller executes instructions from one of two instruction buffers located in either system memory or the display cache (82810-DC100 only): Interrupt Ring or Low Priority Ring. Instead of writing instructions directly to the GMCH's graphics controller, software sets up instruction packets in these memory buffers and then instructs the GMCH to process the buffers. The GMCH uses DMAs to put the instructions into its FIFO and executes them. Instruction flow in the ring buffer instruction stream can make calls to other buffers, much like a software program makes subroutine calls. Flexibility has been built into the ring operation permitting software to efficiently maintain a steady flow of instructions.

Batching instructions in memory ahead of time and then instructing the graphics controller to process the instructions provides significant performance advantages over writing directly to FIFOs including: 1) Reduced software overhead, 2) Efficient DMA instruction fetches from graphics memory, and 3) Software can more efficiently set up instruction packets in buffers in graphics memory (faster than writing to FIFOs).

Figure 8. 3D/2D Pipeline Preprocessor

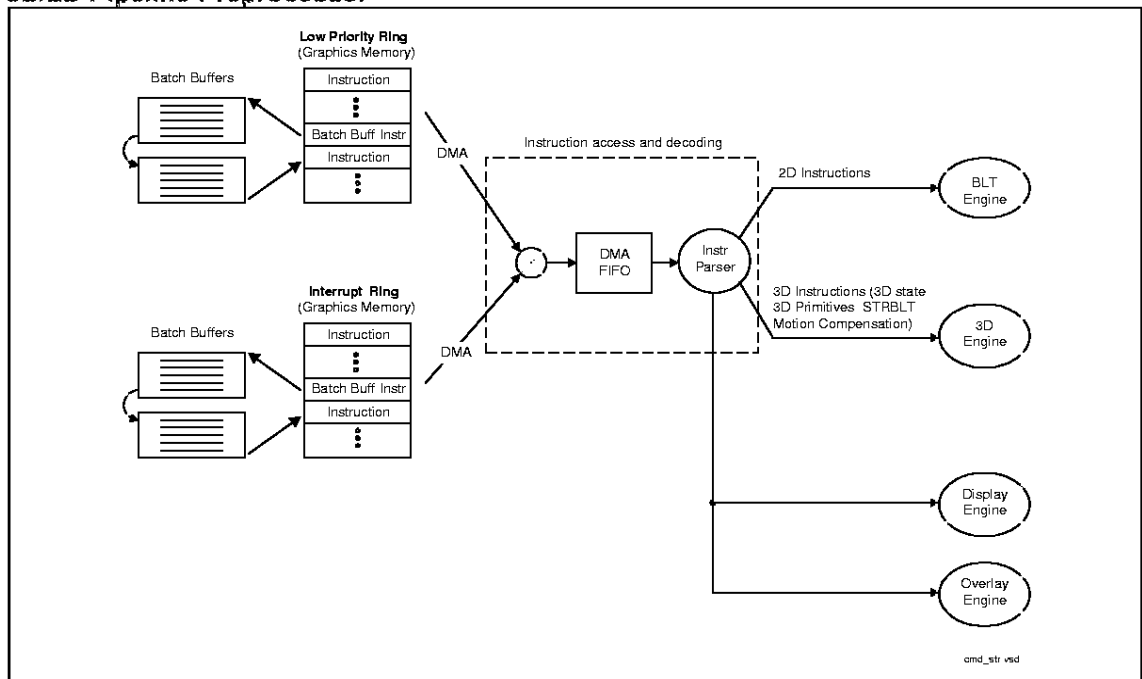

4.6.2. 3D Engine

The 3D engine of the GMCH has been architected as a deep pipeline, where performance is maximized by allowing each stage of the pipeline to simultaneously operate on different primitives or portions of the same primitive. The internal graphics device of the GMCH supports perspective-correct texture mapping, bilinear and anisotropic MIP mapping, gouraud shading, alpha-blending, fogging and Z Buffering. These features can be independently enabled or disabled via set of 3D instructions. This frees up the display cache for other uses (e.g., back and depth buffers, bitmaps, etc.). In addition, the GMCH supports a Dynamic Video Memory (D.V.M.) which allows the entire 3D rendering process to take place in system memory; thus, alleviating the need for the display cache.

The main blocks of the pipeline are the Setup Engine, Scan Converter, Texture Pipeline, and Color Calculator block. A typical programming sequence would be to send instructions to set the state of the pipeline followed by rendering instructions containing 3D primitive vertex data.

4.6.3. Buffers

The 2D, 3D and video capabilities of the internal graphics device of the GMCH provide control over a variety of graphics buffers which can be implemented either in display cache or system memory. To aid the rendering process, the display cache of the GMCH contains two hardware buffers—the Front Buffer (display buffer) and the Back Buffer (rendering buffer). The image being drawn is not visible until the scene is complete and the back buffer made visible (via an instruction) or copied to the front buffer (via a 2D BLT operation). By rendering to one and displaying from the other, the possibility of image tearing is removed. This also speeds up the display process over a single buffer.

The 3D pipeline of the GMCH operates on the Back Buffer and the Z Buffer. The pixels' 16-bit (or 15-bit) RGB colors are stored in the back buffer. The Z-buffer can be used to store 16-bit depth values or 5-bit "destination alpha" values. The Instruction set of the GMCH provides a variety of controls for the buffers (e.g., initializing, flip, clear, etc.).

Figure 9. Data Flow for the 3D Pipeline

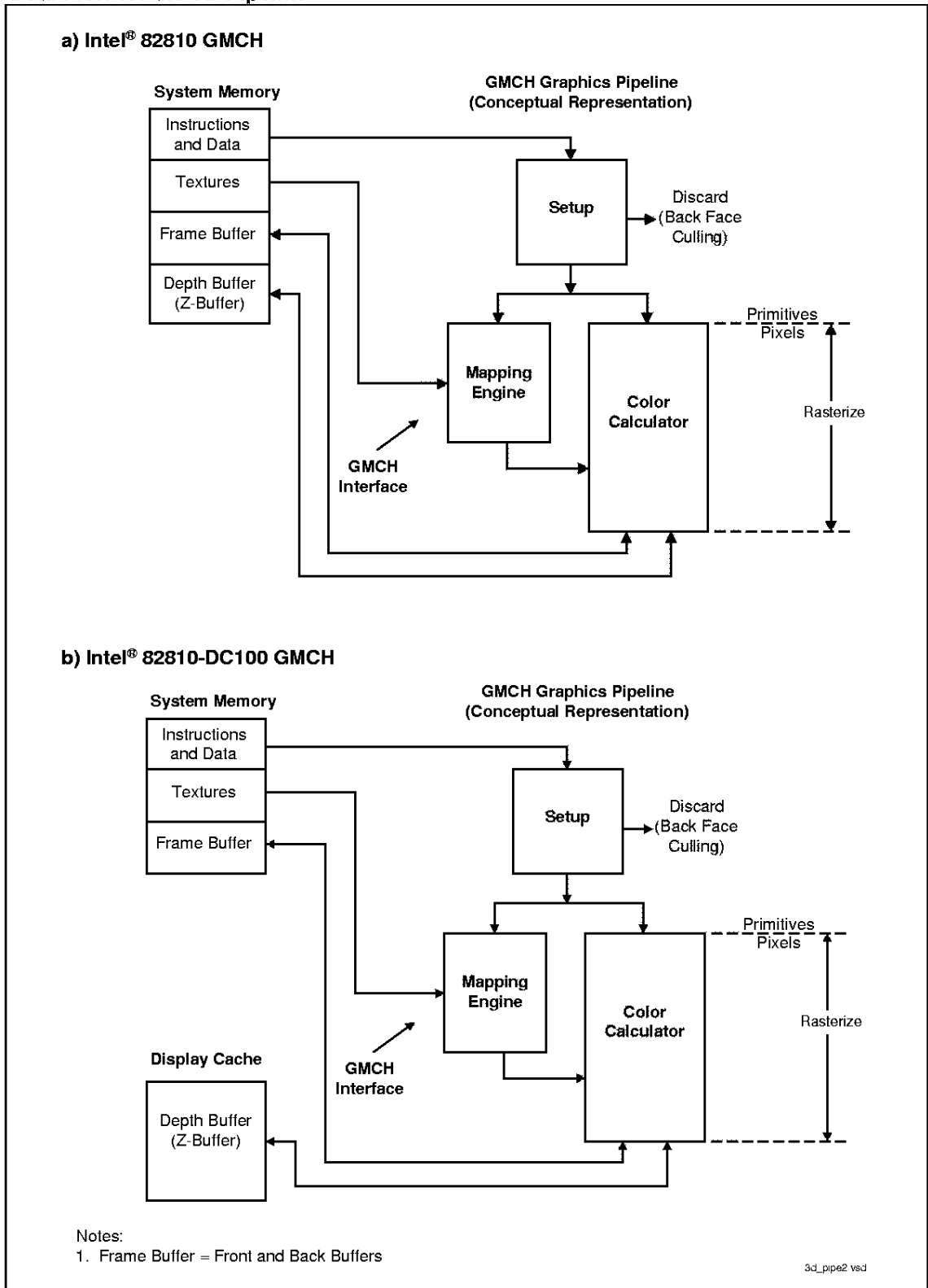

4.6.4. Setup

The setup stage of the pipeline takes the input data associated with each vertex of the line or triangle primitive and computes the various parameters required for scan conversion. In formatting this data, the GMCH maintains sub-pixel accuracy. Data is dynamically formatted for each rendered polygon and output to the proper processing unit. As part of the setup, the GMCH removes polygons from further processing, if they are not facing the user's viewpoint (referred to as "Back Face Culling").

4.6.5. Texturing

The internal graphics device of the GMCH allows an image, pattern, or video to be placed on the surface of a 3D polygon. Textures must be located in system memory. Being able to use textures directly from system memory means that large complex textures can easily be handled without the limitations imposed by the traditional approach of only using the display cache.

The texture processor receives the texture coordinate information from the setup engine and the texture blend information from the scan converter. The texture processor performs texture color or chroma-key matching, texture filtering (anisotropic and bilinear interpolation), and YUV to RGB conversions.

The GMCH supports up to 11 Levels-of-Detail (LODs) ranging in size from 1024x1024 to 1x1 texels. (A texel is defined as a texture map pixel). Textures need not be square. Included in the texture processor is a small cache which provides efficient mip-mapping.

- **Nearest.** Texel with coordinates nearest to the desired pixel is used. (This is used if only one LOD is present).
- **Linear.** A weighted average of a 2x2 area of texels surrounding the desired pixel are used. (This is used if only one LOD is present).
- **Mip Nearest.** This is used if many LODs are present. The appropriate LOD is chosen and the texel with coordinates nearest to the desired pixel are used.
- **Mip Linear.** This is used if many LODs are present. The appropriate LOD is chosen and a weighted average of a 2x2 area of texels surrounding the desired pixel are used. This is also referred to as bi-linear mip-mapping.
- **Anisotropic.** This can be used if multiple LODs are present. This filtering method improves the visual quality of texture-mapped objects when viewed at oblique angles (i.e., with a high degree of perspective foreshortening). The improvement comes from a more accurate (anisotropic) mapping of screen pixels onto texels -- where using bilinear or trilinear filtering can yield overly-blurred results. Situations where anisotropic filtering demonstrates superior quality include text viewed at an angle, lines on roadways, etc.

The GMCH can store each of the above mip-maps in any of the following formats:

- 8bpt Surface Format
- 16bpt Surface Format
 - RGB 565
 - ARGB 1555
 - ARGB 4444
 - AY 88
- 8bpt (Indexed) Surface Format
 - RGB 565
 - ARGB 1555
 - ARGB 4444
 - AY 88
 -
- 4:2:2
 - YCrCb, Swap Y Format
 - YCrCb, Normal
 - YCrCb, UV Swap
 - YCrCb, UV/Y Swap

Many texture mapping modes are supported. Perspective correct mapping is always performed. As the map is fitted across the polygon, the map can be tiled, mirrored in either the U or V directions, or mapped up to the end of the texture and no longer placed on the object (this is known as clamp mode). The way a texture is combined with other object attributes is also definable.

Texture ColorKey and ChromaKey

ColorKey and ChromaKey describe two methods of removing a specific color or range of colors from a texture map before it is applied to an object. For “nearest” texture filter modes, removing a color simply makes those portions of the object transparent (the previous contents of the back buffer show through). For “linear” texture filtering modes, the texture filter is modified if only the non-nearest neighbor texels match the key (range).

ColorKeying occurs with paletted textures, and removes colors according to an index (before the palette is accessed). When a color palette is used with indices to indicate a color in the palette, the indices can be compared against a state variable “ColorKey Index Value” and if a match occurs and ColorKey is enabled, then this value’s contribution is removed from the resulting pixel color. The GMCH defines index matching as ColorKey.

ChromaKeying can be performed for both paletted and non-paletted textures, and removes texels that fall within a specified color range. The ChromaKey mode refers to testing the RGB or YUV components to see if they fall between high and low state variable values. If the color of a texel contribution is in this range and chromaKey is enabled, then this contribution is removed from the resulting pixel color.

Multiple Texture Composition

The GMCH includes support for two simultaneous texture maps. This support greatly reduces the need for multipass compositing techniques for effects such as diffuse light maps, specular reflection maps, bump mapping, detail textures, gloss maps, shadows, and composited effects like dirt or tire marks. Supporting these techniques in hardware greatly increases compositing performance by reducing the need to read and write the frame buffer multiple times.

This multitexture support provides a superset of the “legacy” one-texture (pre-DirectX 6) texture blend modes and a large subset of the operations defined in DirectX 6 and the OpenGL ARB multitexture extensions.

The Multitexture Compositing Unit is capable of combining the interpolated vertex diffuse color, a constant color value, and up to two texels per pixel in a fully-programmable fashion. Up to three operations (combinations) can be performed in a pipelined organization, with intermediate storage to support complex equations, e.g., of the form “ $A*B + C*D$ ” required for light maps and specular gloss maps. Separate operations can be performed on color (RGB) and alpha components.

4.6.6. 2D Operation

The GMCH contains BLT and STRBLT functionality, a hardware cursor, and an extensive set of 2D registers and instructions.

GMCH VGA Registers and Enhancements

The 2D registers are a combination of registers defined by IBM* when the Video Graphics Array (VGA) was first introduced, and others that Intel has added to support graphics modes that have color depths, resolutions, and hardware acceleration features that go beyond the original VGA standard. The internal graphics device of the GMCH improves upon VGA by providing additional features that are used through numerous additional registers.

The GMCH also supports an optional display cache. As an improvement on the VGA standard display cache port-hole, the GMCH also maps the entire display cache into part of a single contiguous memory space at a programmable location, providing what is called “linear” access to the display cache. The size of this memory can be up to 4 MB, and the base address is set via PCI configuration registers. Alternatively, these buffers may be implemented in system memory (via D.V.M.), thus alleviating the need for the display cache.

4.6.7. Fixed Blitter (BLT) and Stretch Blitter (STRBLT) Engines

The GMCH’s 64-bit BLT engine provides hardware acceleration for many common Windows* operations. The following are two primary BLT functions: Fixed Blitter (BLT) and Stretch Blitter (STRBLT). The term BLT refers to a block transfer of pixel data between memory locations. The word “fixed” is used to differentiate from the Stretch BLT engine. The BLT engine can be used for the following:

- Move rectangular blocks of data between memory locations
- Data Alignment
- Perform logical operations

The internal graphics device of the GMCH has instructions to invoke BLT and STRBLT operations, permitting software to set up instruction buffers and use batch processing as described in the 3D/2D Instruction Processing (Pipeline Preprocessor) Section. Note that these instructions replace the need to do PIO directly to BLT and STRBLT registers, which speeds up the operation.

4.6.7.1. Fixed BLT Engine

The rectangular block of data does not change as it is transferred between memory locations. The allowable memory transfers are between: system memory and display cache, display cache and display cache, and system memory and system memory. Data to be transferred can consist of regions of memory, patterns, or solid color fills. A pattern will always be 8x8 pixels wide and may be 8, 16, or 24 bits per pixel.

The internal graphics device of the GMCH has the ability to expand monochrome data into a color depth of 8, 16, or 24 bits. BLTs can be either opaque or transparent. Opaque transfers, move the data specified to the destination. Transparent transfers, compare destination color to source color and write according to the mode of transparency selected.

Data horizontally and vertically aligned at the destination. If the destination for the BLT overlaps with the source memory location, the GMCH can specify which area in memory to begin the BLT transfer. Use of this BLT engine accelerates the Graphical User Interface (GUI) of Microsoft* Windows. Hardware is included for all 256 raster operations (Source, Pattern, and Destination) defined by Microsoft* , including transparent BLT.

4.6.7.2. Arithmetic Stretch BLT Engine

The stretch BLT function can stretch source data in the X and Y directions to a destination larger or smaller than the source. Stretch BLT functionality expands a region of memory into a larger or smaller region using replication and interpolation.

The stretch BLT engine also provides format conversion and data alignment. Through an algorithm implemented in the mapping engine, object expansion and contraction can occur in the horizontal and vertical directions.

4.6.8. Hardware Motion Compensation

The Motion Compensation (MC) process consists of reconstructing a new picture by predicting (either forward, backward or bidirectionally) the resulting pixel colors from one or more reference pictures. The GMCH intercepts the DVD pipeline at Motion Compensation and implements Motion Compensation and subsequent steps in hardware. Performing Motion Compensation in hardware reduces the processor demand of software-based MPEG-2 decoding, and thus improves system performance.

The GMCH's implementation of Hardware Motion Compensation supports a motion smoothing algorithm. When the system processor is not able to process the MPEG decoding stream in a timely manner (as can happen in software DVD implementations), the Intel® 810 graphics accelerator supports downsampled MPEG decoding. Downsampling allows for reduced spatial resolution in the MPEG picture while maintaining a full frame rate, and thus reduces processor load while maintaining the best video quality possible given the processor constraints.

4.6.9. Hardware Cursor

The internal graphics device of the GMCH allows up to an unlimited number of cursor patterns to be stored in the display cache or system memory. Two sets of registers, contain the x and y position of the cursor relative to the upper left corner of the display. The following four cursor modes are provided:

- 32x32 2 bpp AND/XOR 2-plane mode
- 64x64 2 bpp 3-color and transparency mode
- 64x64 2 bpp AND/XOR 2-plane mode
- 64x64 2 bpp 4-color mode

4.6.10. Overlay Engine

The overlay engine provides a method of merging either video capture data (from an external PCI Video Capture Adapter) or data delivered by the CPU, with the graphics data on the screen. Supported data formats include YUV 4:2:2, YUV 4:2:0, YUV 4:1:0, YUV 4:1:1, RGB15, and RGB16. The source data can be mirrored horizontally or vertically or both. Overlay data comes from a buffer located system memory. Additionally, the overlay engine can be quadruple buffered in order to support flipping between different overlay images. Data can either be transferred into the overlay buffer from the host or from an external PCI adapter, such as DVD hardware or video capture hardware. Buffer swaps can be done by the host and internally synchronized with the display VBLANK.

The internal graphics device of the GMCH can accept line widths up to 720 pixels. In addition, overlay source and destination chromakeying are also supported. Overlay source/destination chromakeying enables blending of the overlay with the underlying graphics background. Destination color/chroma keying can be used to handle occluded portions of the overlay window on a pixel by pixel basis which is actually an underlay. Source color/chroma keying is used to handle transparency based on the overlay window on a pixel by pixel basis. This is used when “blue screening” an image in order to overlay the image on a new background later.

To compensate for overlay color intensity loss due to the non-linear response between display devices, the overlay engine supports independent gamma correction. In addition, the brightness, saturation, and contrast of the overlay may be independently varied.

4.6.11. Display

The display function contains a RAM-based Digital-to-Analog Converter (RAMDAC) that transforms the digital data from the graphics and video subsystems to analog data for the monitor. The GMCH's integrated 230 MHz RAMDAC provides resolution support up to 1600x1200. Circuitry is incorporated to limit the switching noise generated by the DACs. Three 8-bit DACs provide the R, G, and B signals to the monitor. Sync signals are properly delayed to match any delays from the D-to-A conversion. Associated with each DAC is a 256 pallet of colors. The RAMDAC can be operated in either direct or indexed color mode. In Direct color mode, pixel depths of 15, 16, or 24 bits can be realized. Non-interlaced mode is supported. Gamma correction can be applied to the display output.

The GMCH supports a wide range of resolutions, color depths, and refresh rates via a programmable dot clock that has a maximum frequency of 230 MHz.

Table 15. Partial List of Display Modes Supported

Resolution	Bits Per Pixel (frequency in Hz)		
	8-bit Indexed	16-bit	24-bit
320x200	70	70	70
320x240	70	70	70
352x480	70	70	70
352x576	70	70	70
400x300	70	70	70
512x384	70	70	70
640x400	70	70	70
640x480	60,70,72,75,85	60,70,72,75,85	60,70,72,75,85
720x480	75,85	75,85	75,85
720x576	60,75,85	60,75,85	60,75,85
800x600	60,70,72,75,85	60,70,72,75,85	60,70,72,75,85
1024x768	60, 70,72,75,85	60, 70,72,75,85	60, 70,72,75,85
1152x864	60,70,72,75,85	60,70,72,75,85	60,70,72,75,85
1280x720	60,75,85	60,75,85	60,75,85
1280x960	60,75,85	60,75,85	60,75,85
1280x1024	60,70,72,75,85	60,70,72,75,85	60,70,75,85
1600x900	60,75,85	60,75,85	
1600x1200	60,70,72,75,85		

4.6.12. Flat Panel Interface / 1.8V TV-Out Interface

The GMCH has a dedicated port for Flat Panel support. This port is a 16 bit digital port (4 control bits and 12 data bits) with a 1.8V interface for high speed signaling. The port is designed to connect to transmission devices. The port can also be used to interface with an external TV encoder that requires 1.8V signals.

Connecting the GMCH to a flat panel transmitter is demonstrated below. For more details, refer to The *Intel® 810 Chipset Design Guide*.

The GMCH supports a variety of Flat Panel display modes and refresh rates that require up to a 65 MHz dot clock over this interface. Table 16 shows some of the display modes supported by the GMCH. Table 17 shows some of the TV-Out modes supported by the GMCH.

Table 16. Partial List of Flat Panel Modes Supported

Resolution	Bits Per Pixel (frequency in Hz)		
	8-bit Indexed	16-bit	24-bit
320x200 ¹	60	60	60
320x240 ¹	60	60	60
352x480 ¹	60	60	60
352x480 ¹	60	60	60
352x576 ¹	60	60	60
400x300 ¹	60	60	60
512x384 ¹	60	60	60
640x350 ¹	60	60	60
640x400 ¹	60	60	60
640x480 ¹	60	60	60
720x480 ¹	60	60	60
720x576 ¹	60	60	60
800x600 ¹	60	60	60
1024x768	60	60	60

NOTES:

1. These resolutions are supported via centering.

Table 17. Partial List of TV-Out Modes Supported

Resolution	Colors	NTSC	PAL
320x200 ¹	256	Yes	Yes
	16M	Yes	Yes
	64k	Yes	Yes
320x240	256	Yes	Yes
	16M	Yes	Yes
	64k	Yes	Yes
352x480 ¹	256	Yes	Yes
	16M	Yes	Yes
	64k	Yes	Yes
352x576 ¹	256	Yes	Yes
	16M	Yes	Yes
	64k	Yes	Yes
400x300 ¹	256	Yes	Yes
	16M	Yes	Yes
	64k	Yes	Yes
640x400 ¹	256	Yes	Yes
640x480	256	Yes	Yes
	64k	Yes	Yes
	16M	Yes	Yes
720x480 ¹	256	Yes	Yes
	64k	Yes	Yes
	16M	Yes	Yes
720x576 ¹	256	Yes	Yes
	64k	Yes	Yes
	16M	Yes	Yes
800x600	16	Yes	Yes
	256	Yes	Yes
	32k	Yes	Yes
	64k	Yes	Yes
	16M	Yes	Yes

NOTES:

1. These resolutions are supported via centering.

4.6.13. DDC (Display Data Channel)

DDC is a standard defined by VESA. Its purpose is to allow communication between the host system and display. Both configuration and control information can be exchanged allowing plug-and-play systems to be realized. Support for DDC 2B is implemented.

4.7. System Reset for the GMCH

Refer to the *Intel® 810 Chipset Design Guide* (Power Sequencing section) for details.

4.8. System Clock Description

The 810 Chipset is supported by a CK810 clock synthesizer. Refer to the *Intel® 810 Chipset Design Guide* for details.

CK810 Features (56 Pin SSOP Package):

- 3 copies of CPU Clock 66 MHz/100 MHz (2.5V) [CPU, GCH, ITP]
- 9 copies of 100 MHz (all the time) SDRAM Clock (3.3V) [SDRAM0..7, DCclk]
- 8 copies of PCI Clock (33 MHz) (3.3V)
- 2 copies of APIC Clock @16.67 MHz or 33 MHz, synchronous to CPU Clock (2.5V)
- 2 copy of 48 MHz Clock (3.3V) [Non SSC]
- 2 copies of 3V66 MHz Clock (3.3V)
- 1 copy of REF Clock at 14.31818 MHz (3.3V) also used as input strap to determine APIC frequency
- 66 MHz or 100 MHz CPU operation (Selectable at power up only)
- Ref. 14.31818 MHz Xtal Oscillator Input
- Power Down Pin
- Spread Spectrum Support
- I²C Support for turning off unused clocks

4.9. Power Management

4.9.1. Specifications Supported

The platform is compliant with the following specifications:

- APM Rev 1.2
- ACPI Rev 1.0
- PCI Power Management Rev 1.0
- PC'98/99, Rev 1.0

5. *Pinout and Package Information*

5.1. 82810 and 82810-DC100 GMCH Pinout

Figure 10 and Figure 11 show the ball foot print of the 82810 and 82810-DC100 . These figures represent the ballout by ball number. Table 18 provides an alphabetical signal listing of the ballout.

Figure 10. GMCH Pinout (Top View-Left Side)

	1	2	3	4	5	6	7	8	9	10	11	12	
A	VSS	SCKE1	SCKE0	SMAB7#	SMAA11	SMAB5#	SMAA7	SMAA5	SMAA2	SDQM1	SCAS#	SMD15	
B	SDQM2	VSUS_3.3	SCS2#	SMAB6#	VSS	SMAB4#	SMAA6	SMAA4	VSS	SDQM4	SWE#	SMD40	
C	SDQM6	SCS3#	SCS1#	SCS0#	SBS0	SMAA9	VSUS_3.3	SMD47	SMAA0	SDQM0	VSUS_3.3	SMD41	
D	SDQM3	SDQM7	SMD20	VSUS_3.3	SMAA10	SMAA8	SMAA3	SRAS#	SDQM5	SMD43	SMD42	SMD38	
E	SMD16	VSS	SMD53	SMD52	SBS1	SCLK	SMAA1	SMD46	SMD45	SMD44	VSS	SMD37	
F	SMD49	SMD17	SMD48	SMD54	SMD56	VSUS_3.3	V_1.8	V_1.8	VSUS_3.3	V_1.8			
G	SMD19	SMD50	VSUS_3.3	SMD18	SMD57	VSS							
H	SMD22	SMD21	SMD51	SMD59	SMD58	SMD60							
J	SMD24	VSS	SMD55	SMD23	SMD61	VSS							
K	SMD26	SMD25	SMD27	SMD31	SMD62	VSUS_3.3					VSS	VSS	VSS
L	SMD28	SMD29	VSUS_3.3	VSS	SMD63						VSS	VSS	VSS
M	VSS	RESET#	SMD30	DBSY#	GTLREFA						VSS	VSS	VSS
N	DRDY#	RS2#	ADS#	HTRDY#	RS0#						VSS	VSS	VSS
P	HIT#	RS1#	VSS	HREQ2#	HLOCK#	V_1.8					VSS	VSS	VSS
R	HITM#	HREQ3#	DEFER#	HREQ0#	HREQ4#	VSS							
T	BPRI#	HREQ1#	BNR#	HA7#	HA14#	VSS							
U	HA4#	HA8#	HA9#	HA11#	HA3#	VCCHA							
V	HA6#	HA16#	VSS	HA5#	HD8#	HCLK	V_1.8	V_1.8	V_1.8	V_1.8			
W	HA10#	HA15#	HA12#	HA13#	HD1#	VSS	HD14#	HD2#	HD16#	VSS	HD32#	HD34#	
Y	HA28#	HA25#	HA19#	HA30#	HD0#	HD5#	HD18#	HD13#	HD30#	HD26#	HD29#	HD38#	
AA	HA21#	HA18#	HA24#	VSS	HD6#	HD3#	HD12#	VSS	HD7#	HD19#	HD35#	VSS	
AB	HA31#	HA22#	HA20#	CPURST#	HA26#	HD4#	HD10#	HD20#	HD24#	HD23#	HD25#	HD28#	
AC	VSS	HA17#	HA23#	HA27#	HA29#	HD15#	HD9#	HD11#	HD17#	HD21#	HD33#	HD31#	

NOTES:

1. An asterisk indicates signals that are only available on the 82810-DC100. For the 82810, these signals are either no connects or used for power-on strapping options.

Figure 11. GMCH Pinout (Top View-Right Side)

	13	14	15	16	17	18	19	20	21	22	23	
	SMD14	SMD11	SMD8	SMD6	SMD5	HL7	HL10	HLSTRB#	HLSTRB	HL8	HL3	A
	VSS	SMD10	SMD39	SMD7	VSS	HL5	HL4	V_1.8	VSS	HL2	HL1	B
	SMD13	SMD9	VSUS_3.3	SMD1	SMD4	HL6	VSS	HL9	HL0	LMD23*	LDQM2*	C
	SMD12	SMD34	SMD2	SMD32	SMD3	HCOMP	HLCLK	HUBREF	LMD22*	LMD20*	LMD21*	D
	SMD36	SMD35	SMD33	VSS	SMD0	VSS	VCCBA	LMD17*	LMD18*	VSS	LMD19*	E
		V_1.8	VSUS_3.3	V_1.8	V_1.8	V_3.3	LMA9*	LDQM3*	LMD30*	LMD31*	LMD16*	F
						VSS	LMA8*	LMD27*	V_3.3	LMD28*	LMD29*	G
						LMA7*	LMA5*	LMA6*	LMD24*	LMD25*	LMD26*	H
						V_3.3	LWE#*	LRCLK	LMA4*	VSS	LOCLK	J
						VSS	LRAS#	LCAS#	LMD4*	LTCLK	LMD5*	K
							LMA11*	LCS#*	V_3.3	LMD3*	LMD2*	L
							LMA0*	LMA10*	LMD1*	LMD0*	LMD15*	M
							LMA3*	LMD14*	LMD13*	VSS	LMD12*	N
						VSS	LMA1*	LMA2*	LDQM0*	LMD11*	LMD10*	P
						V_3.3	LMD6*	LMD7*	LMD9*	LMD8*	LDQM1*	R
						VSS	LTVCL	LTVDA	LTVDATA11	LTVDATA10	LTVDATA9	T
						V_1.8	TVHSYNC	TVCLKin/ INT#	LTVDATA8	LTVDATA7	LTVDATA6	U
		V_1.8	V_1.8	V_1.8	V_1.8	VSS	BLANK#	TVVSYNC	CLKOUT0	CLKOUT1	LTVDATA5	V
	GTLREFB	VSS	HD52#	HD57#	HD54#	HD56#	DDCSDA	DDCSCL	LTVDATA4	LTVDATA3	LTVDATA2	W
	HD37#	HD42#	HD47#	HD59#	HD46#	HD61#	VSS	LTVDATA1	LTVDATA0	VSS	IWASTE	Y
	HD36#	HD44#	HD40#	VSS	HD55#	HD50#	VSS	VSYN	DCLKREF	VSSDA	IREF	AA
	HD22#	HD45#	HD51#	HD27#	HD63#	HD53#	HD60#	HSYN	VCCDACA2	VSSDACA	VCCDACA1	AB
	HD43#	HD39#	HD41#	HD49#	HD48#	HD62#	HD58#	VCCDA	RED	GREEN	BLUE	AC

VSS	VSS
VSS	VSS
VSS	VSS
VSS	VSS
VSS	VSS

NOTES:

1. An asterisk indicates signals that are only available on the 82810-DC100. For the 82810, these signals are either no connects or used for power-on strapping options.

Table 18. Alphabetical Pin Assignment

Pin Name	Ball #	Pin Name	Ball #	Pin Name	Ball #	Pin Name	Ball #
ADS#	N3	HA20#	AB3	HD20#	AB8	HD54#	W17
BLANK#	V19	HA21#	AA1	HD21#	AC10	HD55#	AA17
BLUE	AC23	HA22#	AB2	HD22#	AB13	HD56#	W18
BNR#	T3	HA23#	AC3	HD23#	AB10	HD57#	W16
BPRI#	T1	HA24#	AA3	HD24#	AB9	HD58#	AC19
CLKOUT0	V21	HA25#	Y2	HD25#	AB11	HD59#	Y16
CLKOUT1	V22	HA26#	AB5	HD26#	Y10	HD60#	AB19
CPURST#	AB4	HA27#	AC4	HD27#	AB16	HD61#	Y18
DBSY#	M4	HA28#	Y1	HD28#	AB12	HD62#	AC18
DCLKREF	AA21	HA29#	AC5	HD29#	Y11	HD63#	AB17
DDCSCL	W20	HA30#	Y4	HD30#	Y9	HIT#	P1
DDCSDA	W19	HA31#	AB1	HD31#	AC12	HITM#	R1
DEFER#	R3	HCLK	V6	HD32#	W11	HL0	C21
DRDY#	N1	HCOMP	D18	HD33#	AC11	HL1	B23
GREEN	AC22	HD0#	Y5	HD34#	W12	HL2	B22
GTLREFA	M5	HD1#	W5	HD35#	AA11	HL3	A23
GTLREFB	W13	HD2#	W8	HD36#	AA13	HL4	B19
HA3#	U5	HD3#	AA6	HD37#	Y13	HL5	B18
HA4#	U1	HD4#	AB6	HD38#	Y12	HL6	C18
HA5#	V4	HD5#	Y6	HD39#	AC14	HL7	A18
HA6#	V1	HD6#	AA5	HD40#	AA15	HL8	A22
HA7#	T4	HD7#	AA9	HD41#	AC15	HL9	C20
HA8#	U2	HD8#	V5	HD42#	Y14	HL10	A19
HA9#	U3	HD9#	AC7	HD43#	AC13	HLCLK	D19
HA10#	W1	HD10#	AB7	HD44#	AA14	HLOCK#	P5
HA11#	U4	HD11#	AC8	HD45#	AB14	HLSTRB	A21
HA12#	W3	HD12#	AA7	HD46#	Y17	HLSTRB#	A20
HA13#	W4	HD13#	Y8	HD47#	Y15	HREQ0#	R4
HA14#	T5	HD14#	W7	HD48#	AC17	HREQ1#	T2
HA15#	W2	HD15#	AC6	HD49#	AC16	HREQ2#	P4
HA16#	V2	HD16#	W9	HD50#	AA18	HREQ3#	R2
HA17#	AC2	HD17#	AC9	HD51#	AB15	HREQ4#	R5
HA18#	AA2	HD18#	Y7	HD52#	W15	HSYNC	AB20
HA19#	Y3	HD19#	AA10	HD53#	AB18	HTRDY#	N4

Pin Name	Ball #
HUBREF	D20
IREF	AA23
IWASTE	Y23
LCAS#	K20
LCS#*	L20
LDQM0*	P21
LDQM01*	R23
LDQM02*	C23
LDQM03*	F20
LMA0*	M19
LMA1*	P19
LMA2*	P20
LMA3*	N19
LMA4*	J21
LMA5*	H19
LMA6*	H20
LMA7*	H18
LMA8*	G19
LMA9*	F19
LMA10*	M20
LMA11*	L19
LMD0*	M22
LMD1*	M21
LMD2*	L23
LMD3*	L22
LMD4*	K21
LMD5*	K23
LMD6*	R19
LMD7*	R20
LMD8*	R22
LMD9*	R21
LMD10*	P23
LMD11*	P22
LMD12*	N23
LMD13*	N21
LMD14*	N20

Pin Name	Ball #
LMD15*	M23
LMD16*	F23
LMD17*	E20
LMD18*	E21
LMD19*	E23
LMD20*	D22
LMD21*	D23
LMD22*	D21
LMD23*	C22
LMD24*	H21
LMD25*	H22
LMD26*	H23
LMD27*	G20
LMD28*	G22
LMD29*	G23
LMD30*	F21
LMD31*	F22
LOCLK	J23
LRAS#	K19
LRCLK	J20
LTCLK	K22
LTVCL	T19
LTVDA	T20
LTVDATA0	Y21
LTVDATA1	Y20
LTVDATA2	W23
LTVDATA3	W22
LTVDATA4	W21
LTVDATA5	V23
LTVDATA6	U23
LTVDATA7	U22
LTVDATA8	U21
LTVDATA9	T23
LTVDATA10	T22
LTVDATA11	T21
LWE#*	J19

Pin Name	Ball #
RED	AC21
RESET#	M2
RS0#	N5
RS1#	P2
RS2#	N2
SBS0	C5
SBS1	E5
SCAS#	A11
SCKE0	A3
SCKE1	A2
SCLK	E6
SCS0#	C4
SCS1#	C3
SCS2#	B3
SCS3#	C2
SDQM0	C10
SDQM1	A10
SDQM2	B1
SDQM3	D1
SDQM4	B10
SDQM5	D9
SDQM6	C1
SDQM7	D2
SMAA0	C9
SMAA1	E7
SMAA2	A9
SMAA3	D7
SMAA4	B8
SMAA5	A8
SMAA6	B7
SMAA7	A7
SMAA8	D6
SMAA9	C6
SMAA10	D5
SMAA11	A5
SMAB4#	B6

Pin Name	Ball #
SMAB5#	A6
SMAB6#	B4
SMAB7#	A4
SMD0	E17
SMD1	C16
SMD2	D15
SMD3	D17
SMD4	C17
SMD5	A17
SMD6	A16
SMD7	B16
SMD8	A15
SMD9	C14
SMD10	B14
SMD11	A14
SMD12	D13
SMD13	C13
SMD14	A13
SMD15	A12
SMD16	E1
SMD17	F2
SMD18	G4
SMD19	G1
SMD20	D3
SMD21	H2
SMD22	H1
SMD23	J4
SMD24	J1
SMD25	K2
SMD26	K1
SMD27	K3
SMD28	L1
SMD29	L2
SMD30	M3
SMD31	K4
SMD32	D16

Pin Name	Ball #
SMD33	E15
SMD34	D14
SMD35	E14
SMD36	E13
SMD37	E12
SMD38	D12
SMD39	B15
SMD40	B12
SMD41	C12
SMD42	D11
SMD43	D10
SMD44	E10
SMD45	E9
SMD46	E8
SMD47	C8
SMD48	F3
SMD49	F1
SMD50	G2
SMD51	H3
SMD52	E4
SMD53	E3
SMD54	F4
SMD55	J3
SMD56	F5
SMD57	G5
SMD58	H5
SMD59	H4
SMD60	H6
SMD61	J5
SMD62	K5
SMD63	L5
SRAS#	D8
SWE#	B11
TVCLKin/ INT#	U20
TVHSYNC	U19
TVVSYNC	V20

Pin Name	Ball #
V_1.8	P6
V_1.8	F7
V_1.8	V7
V_1.8	F8
V_1.8	V8
V_1.8	V9
V_1.8	F10
V_1.8	V10
V_1.8	F14
V_1.8	V14
V_1.8	V15
V_1.8	F16
V_1.8	V16
V_1.8	F17
V_1.8	V17
V_1.8	U18
V_1.8	B20
V_3.3	F18
V_3.3	J18
V_3.3	R18
V_3.3	G21
V_3.3	L21
VCCBA	E19
VCCDA	AC20
VCCDACA1	AB23
VCCDACA2	AB21
VCCHA	U6
VSS	A1
VSS	M1
VSS	AC1
VSS	E2
VSS	J2
VSS	P3
VSS	V3
VSS	L4
VSS	AA4

Pin Name	Ball #
VSS	B5
VSS	G6
VSS	J6
VSS	R6
VSS	T6
VSS	W6
VSS	AA8
VSS	B9
VSS	K10
VSS	L10
VSS	M10
VSS	N10
VSS	P10
VSS	W10
VSS	E11
VSS	K11
VSS	L11
VSS	M11
VSS	N11
VSS	P11
VSS	K12
VSS	L12
VSS	M12
VSS	N12
VSS	P12
VSS	AA12
VSS	B13
VSS	K13
VSS	L13
VSS	M13
VSS	N13
VSS	P13
VSS	K14
VSS	L14
VSS	M14
VSS	N14

Pin Name	Ball #
VSS	P14
VSS	W14
VSS	E16
VSS	AA16
VSS	B17
VSS	E18
VSS	G18
VSS	K18
VSS	P18
VSS	T18
VSS	V18
VSS	C19
VSS	Y19
VSS	AA19
VSS	B21
VSS	E22
VSS	J22
VSS	N22
VSS	Y22
VSSDA	AA22
VSSDACA	AB22
VSUS_3.3	B2
VSUS_3.3	G3
VSUS_3.3	L3
VSUS_3.3	D4
VSUS_3.3	F6
VSUS_3.3	K6
VSUS_3.3	C7
VSUS_3.3	F9
VSUS_3.3	C11
VSUS_3.3	C15
VSUS_3.3	F15
VSYNC	AA20

5.2. Package Dimensions

This section shows the mechanical dimensions for the 82810 and 82810-DC100 devices. The package is a 421 Ball Grid Array (BGA).

Figure 12. GMCH Package Dimensions (421 BGA) – Top and Side Views

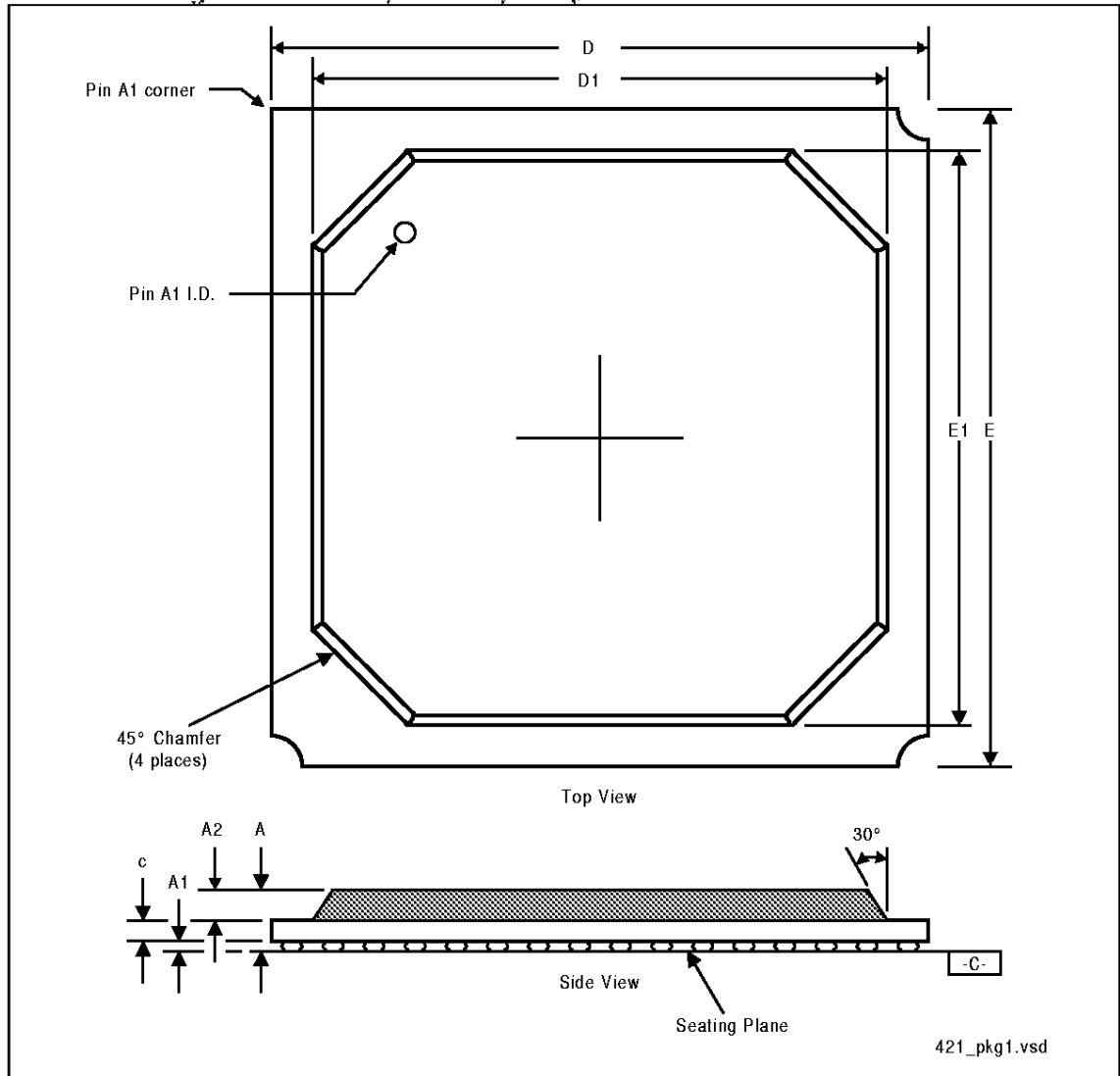

Figure 13. GMCH Package Dimensions (421 BGA) – Top and Side Views

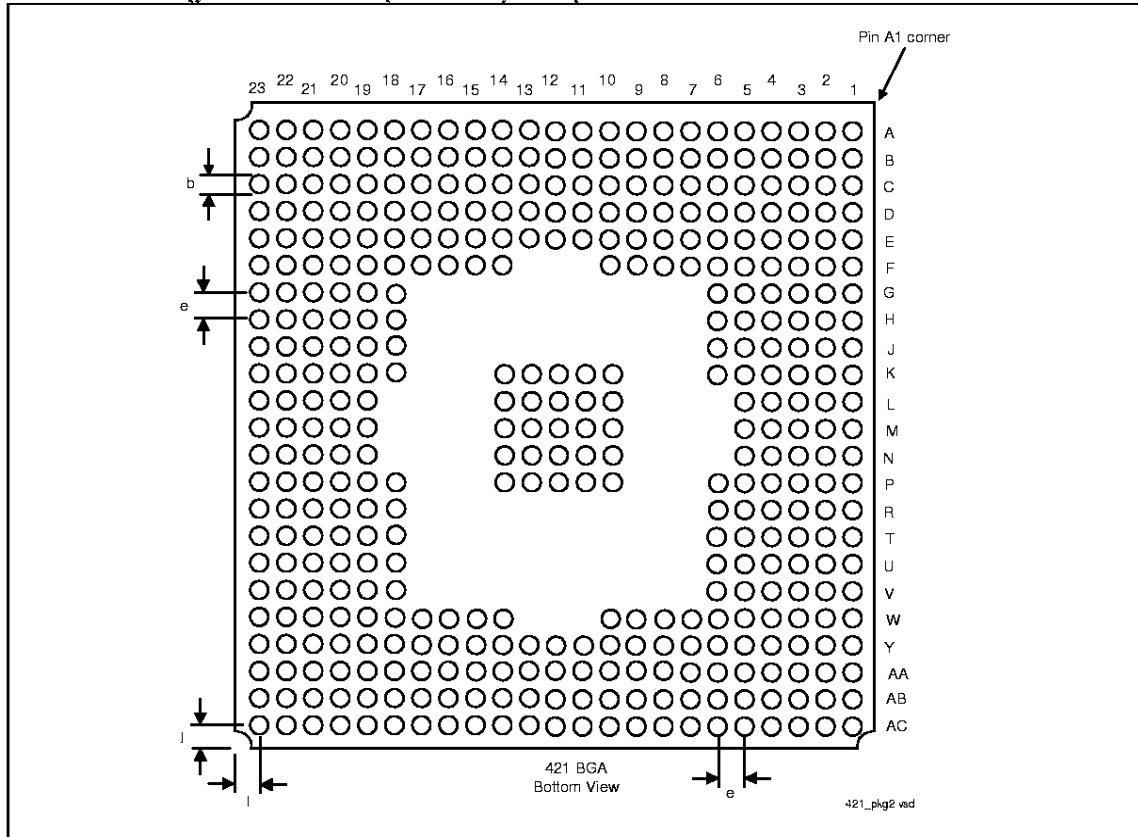

Table 19. GMCH Package Dimensions (421 BGA)

Symbol	Min	Nominal	Max	Units	Note
A	2.17	2.38	2.59	mm	
A1	0.50	0.60	0.70	mm	
A2	1.12	1.17	1.22	mm	
D	30.80	31.00	31.20	mm	
D1	25.80	26.00	26.20	mm	
E	30.90	31.00	31.10	mm	
E1	25.80	26.00	26.20	mm	
e	1.27 (solder ball pitch)			mm	
I	1.53 REF.			mm	
J	1.53 REF.			mm	
M	23 x 23 Matrix			mm	
b ²	0.60	0.75	0.90	mm	
c	0.55	0.61	0.67	mm	

NOTES: Notes:

1. All dimensions and tolerances conform to ANSI Y14.5-1982
2. Dimension is measured at maximum solder ball diameter parallel to primary datum (-C-)
3. Primary Datum (-C-) and seating plane are defined by the spherical crowns of the solder balls.

6. Testability

In the GMCH, the testability for Automated Test Equipment (ATE) board level testing has been changed from the traditional NAND chain mode to a XOR chain. The GMCH pins are grouped in seven XOR chains.

An XOR-Tree is a chain of XOR gates each with one of its inputs connected to a GMCH input pin or bi-directional pin (used as an input pin only). The other input of each XOR gate connects to the non-inverted output of the previous XOR gate in the chain. The first XOR gate of each chain will have one pin internally connected tied to Vcc. The output of the last XOR gate is the chain output. Figure 14 shows the GMCH XOR chain implementation.

Figure 14. XOR Tree Implementation

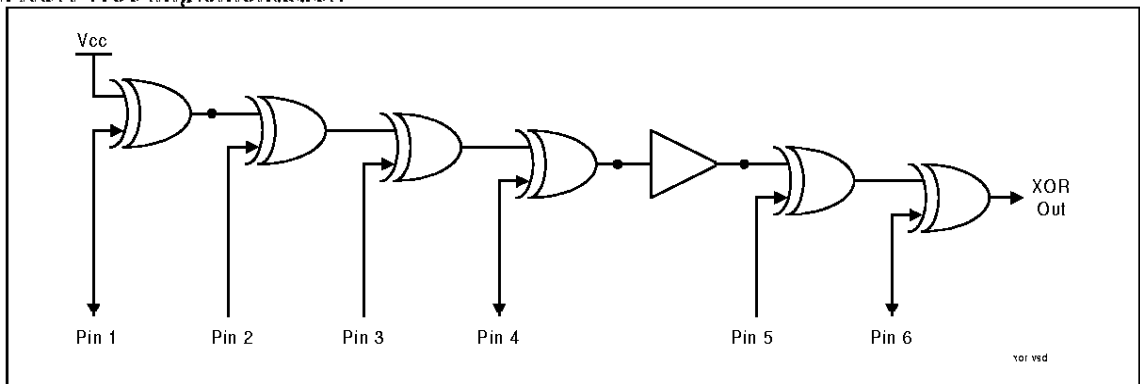

Tri-state GMCH Outputs

When testing other devices in the system, the GMCH outputs can be tri-stated. To tri-state these outputs pull the LMD30 pin high (3.3V) prior to deasserting RESET#. The following sequence will put the GMCH into tri-state mode:

1. Deassert RESET# high and LMD30 high
2. Assert RESET# low; maintain LMD30 high
3. Deassert RESET# high; maintain LMD30 high
4. RESET# must be maintained high for the duration of testing.

No external clocking of the GMCH is required.

6.1. XOR TREE Testability Algorithm Example

XOR tree testing allows users to check, for example, opens and shorts to VCC or GND. An example algorithm to do this is shown in Table 20.

Table 20. XOR Test Pattern Example

Pin # from Figure 14							
Vector	PIN1	PIN2	PIN3	PIN4	PIN5	PIN6	XOROut
1	0	0	0	0	0	0	1
2	1	0	0	0	0	0	0
3	1	1	0	0	0	0	1
4	1	1	1	0	0	0	0
5	1	1	1	1	0	0	1
6	1	1	1	1	1	0	0
7	1	1	1	1	1	1	1

In this example, Vector 1 applies all “0s” to the chain inputs. The outputs being non-inverting, will consistently produce a “1” at the XOR chain output on a good board. One short to Vcc (or open floating to Vcc) will cause a “0” at the chain output, signalling a defect.

Likewise, applying Vector 7 (all “1”) to chain inputs (given that there are an even number of signals in the chain), will consistently produce a “1” at the XOR chain output on a good board. One short to Vss (or open floating to Vss) will cause a “0” at the chain output, signalling a defect. It is important to note that the number of inputs pulled to “1” will affect the expected chain output value. If the number chain inputs pulled to “1” is even, then expect “1” at XOR-out; otherwise, if odd, expect “0”.

Continuing to illustrate with the example pattern in Table 20, as the pins are driven to “1” across the chain in sequence, XOR-out will toggle between “0” and “1”. Any break in the toggling sequence (e.g., “1011”) will identify the location of the short or open.

6.1.1. Test Pattern Consideration for XOR Chain 7

Bi-directional pins HLSTRB (chain 7) and HLSTRB# (chain 6) must always be complementary to each other. For example, if a “1” is driven on to HLSTRB, a “0” must be driven on HLSTRB# and vice versa. This will need to be considered in applying test patterns to this chain.

6.2. XOR Tree Initialization

6.2.1. Chain [1:2, 4:7] Initialization

On chains [1:2,4:7], all that is required to prepare the device for XOR chain testing is to pull LMD31 high (+3.3V) prior to the deasserting RESET#. LMD31 must be brought back to a low state after this sequence, as this pin is part of XOR chain 2. The following sequence will put the GMCH into XOR testability mode:

1. Deassert RESET# high and LMD31 (high)
2. Assert RESET# low; maintain LMD31 (high)
3. Deassert RESET# high; maintain LMD31 (high)
4. RESET# must be maintained high for the duration of testing.

No external clocking of the GMCH is required for testing these chains.

6.2.2. Chain 3 Initialization

To test XOR chain 3, a different initialization sequence is required. The following steps need to be implemented:

1. Provide clocks at a minimum frequency of 10 MHz to the GMCH host clock (HCLK), hub interface clock (HLCLK), and display interface clock (DCLKREF). Phase relationship between HCLK and HLCLK must be maintained such that they are 180 degrees out of phase, and their edges line up within 400 pS.
2. Deassert RESET# high and assert LMD31 high
3. Assert RESET# low for 35,000 HLCLKs; maintain LMD31 high
4. Deassert RESET# high for 35,000 HLCLKs; maintain LMD31 high
5. Chain #3 is now initialized and ready to begin XOR test. RESET# must be maintained high for the duration of testing.

6.3. XOR Chain Pin Assignments

Pin Name	Ball#	Voltage
LMD6 (start)	R19	3.3V
LMD7	R20	3.3V
LMD9	R21	3.3V
LMD8	R22	3.3V
LMA1	P19	3.3V
LDQM1	R23	3.3V
LMA2	P20	3.3V
LDQM0	P21	3.3V
LMD11	P22	3.3V
LMD10	P23	3.3V
LMA3	N19	3.3V
LMD14	N20	3.3V
LMD13	N21	3.3V
LMD12	N23	3.3V
LMD15	M23	3.3V
LMD0	M22	3.3V
LMD1	M21	3.3V
LMA0	M19	3.3V
LCAS#	K20	3.3V
LMA4	J21	3.3V
LMA5	H19	3.3V
LMD21	D23	3.3V
LMD18	E21	3.3V
LMD20	D22	3.3V
LMD17	E20	3.3V
LMD22	D21	3.3V
LMD23 (end)	C22	3.3V
Length = 27		
Chain 1 Output		
LRAS#	K19	3.3V

NOTES:

- Chain 1 = Odd Number of XOR Gates: All "1s" yields LRAS# = "0"

Table 22. XOR Chain 2

Pin Name	Ball #	Voltage
LMA10 (start)	M2	3.3V
LMD2	L23	3.3V
LMD3	L22	3.3V
LCS#	L20	3.3V
LMA11	L19	3.3V
LMD5	K23	3.3V
LTCLK	K22	3.3V
LMD4	K21	3.3V
LOCLK	J23	3.3V
LMD26	H23	3.3V
LRCLK	J20	3.3V
LMD25	H22	3.3V
LMD24	H21	3.3V
LMD29	G23	3.3V
LMA6	H20	3.3V
LMD28	G22	3.3V
LMD16	F23	3.3V
LMD31	F22	3.3V
LMD27	G20	3.3V
LMD19	E23	3.3V
LMD30	F21	3.3V
LMA7	H18	3.3V
LMA8	G19	3.3V
LDQM3	F20	3.3V
LDQM2	C23	3.3V
LMA9 (end)	F19	3.3V
Length = 26		
Chain 2 Output		
LWE#	J19	3.3V

NOTES:

- Chain 2 = Even Number of XOR gates: All "1s" yields LWE# = "1"

Table 23. XOR Chain 3

Pin Name	Ball#	Voltage
BLANK#	V19	1.8V
LTVDATA1	Y20	1.8V
TVVSYNC	V20	1.8V
TVHSYNC	U19	1.8V
LTVDATA4	W21	1.8V
LTVDATA3	W22	1.8V
FPCLKOUT0	V21	1.8V
LTVDATA2	W23	1.8V
FPCLKOUT1	V22	1.8V
LTVDATA8	U21	1.8V
LTVDATA5	V23	1.8V
LTVDATA7	U22	1.8V
LTVDATA6	U23	1.8V
LTVDATA11	T21	1.8V
LTVDATA10	T22	1.8V
LTVDATA9	T23	1.8V
TVCLKIN	U20	1.8V
VSYNC	AA20	3.3V
HSYNC	AB20	3.3V
LTVDA	T20	3.3V
LTVCL	T19	3.3V
DDCSCL	W20	3.3V
DDCSDA	W19	3.3V
HA29#	AC5	1.5V
HD32#	W11	1.5V
HD35#	AA11	1.5V
HD33#	AC11	1.5V
HD38#	Y12	1.5V
HD34#	W12	1.5V
HD43#	AC13	1.5V
HD36#	AA13	1.5V
HD37#	Y13	1.5V
HD39#	AC14	1.5V
HD45#	AB14	1.5V
HD44#	AA14	1.5V

Table 23. XOR Chain 3

Pin Name	Ball#	Voltage
HD42#	Y14	1.5V
HD41#	AC15	1.5V
HD51#	AB15	1.5V
HD40#	AA15	1.5V
HD47#	Y15	1.5V
HD49#	AC16	1.5V
HD52#	W15	1.5V
HD48#	AC17	1.5V
HD59#	Y16	1.5V
HD63#	AB17	1.5V
HD62#	AC18	1.5V
HD55#	AA17	1.5V
HD57#	W16	1.5V
HD53#	AB18	1.5V
HD46#	Y17	1.5V
HD58#	AC19	1.5V
HD50#	AA18	1.5V
HD54#	W17	1.5V
HD60#	AB19	1.5V
HD61#	Y18	1.5V
HD56#	W18	1.5V
Length = 56		
Chain 3 Output		
LTVDATA0	Y21	1.8V

NOTES:

- Chain 3 = Even Number of XOR Gates: All "1s" yields LTVDATA0 = "1"

Table 24. XOR Chain 4

Pin Name	Ball#	Voltage
HD27# (start)	AB16	1.5V
HA14#	T5	1.5V
HA16#	V2	1.5V
HA11#	U4	1.5V
HA10#	W1	1.5V
HA3#	U5	1.5V
HA15#	W2	1.5V
HA28#	Y1	1.5V
HA5#	V4	1.5V
HA12#	W3	1.5V
HA25#	Y2	1.5V
HA21#	AA1	1.5V
HD8#	V5	1.5V
HA13#	W4	1.5V
HA19#	Y3	1.5V
HA18#	AA2	1.5V
HA31#	AB1	1.5V
HA24#	AA3	1.5V
HA22#	AB2	1.5V
HD1#	W5	1.5V
HA30#	Y4	1.5V
HA17#	AC2	1.5V
HA20#	AB3	1.5V
HD0#	Y5	1.5V
HA23#	AC3	1.5V
CPURST#	AB4	1.5V
HD6#	AA5	1.5V
HD5#	Y6	1.5V
HA27#	AC4	1.5V
HA26#	AB5	1.5V
HD14#	W7	1.5V
HD3#	AA6	1.5V
HD18#	Y7	1.5V
HD4#	AB6	1.5V
HD2#	W8	1.5V

Table 24. XOR Chain 4

Pin Name	Ball#	Voltage
HD12#	AA7	1.5V
HD15#	AC6	1.5V
HD10#	AB7	1.5V
HD13#	Y8	1.5V
HD9#	AC7	1.5V
HD16#	W9	1.5V
HD20#	AB8	1.5V
HD30#	Y9	1.5V
HD11#	AC8	1.5V
HD7#	AA9	1.5V
HD24#	AB9	1.5V
HD17#	AC9	1.5V
HD26#	Y10	1.5V
HD19#	Y10	1.5V
HD23#	AB10	1.5V
HD21#	AC10	1.5V
HD29#	Y11	1.5V
HD25#	AB11	1.5V
HD31#	AC12	1.5V
HD28#	AB12	1.5V
HD22#	AB13	1.5V
Length =56		
Chain 4 Output		
SDQM3	D1	3.3V

NOTES:

- Chain 4 = Even Number of XOR Gates: All "1s" yields SDQM3 = "1"

Table 25. XOR Chain 5

Pin Name	Ball#	Voltage
SDQM1 (start)	A10	3.3V
SDQM0	C10	3.3V
SMAA2	A9	3.3V
SMD45	E9	3.3V
SMD47	C8	3.3V
SMAA5	A8	3.3V
SMAA4	B8	3.3V
SMAB#7	A4	3.3V
SMAB#6	B4	3.3V
SCKE0	A3	3.3V
SCKE1	A2	3.3V
SMAA1	E7	3.3V
SMAA3	D7	3.3V
SMD46	E8	3.3V
SBS0	C5	3.3V
SMD56	F5	3.3V
SCS0#	C4	3.3V
SMD57	G5	3.3V
SCSB1	C3	3.3V
SMD52	E4	3.3V
SMD20	D3	3.3V
SMD54	F4	3.3V
SMD53	E3	3.3V
SMD58	H5	3.3V
SDQM2	B1	3.3V
SMD18	G4	3.3V
SMD60	H6	3.3V
SMD48	F3	3.3V
SMD63	L5	3.3V
SMD29	L5	3.3V
SMD28	L1	3.3V
SMD30	M3	3.3V
DBSY#	M4	1.5V
DRDY#	N1	1.5V
RS2#	N2	1.5V

Table 25. XOR Chain 5

Pin Name	Ball#	Voltage
ADS#	N3	1.5V
HTRDY#	N4	1.5V
RS0#	N5	1.5V
HIT#	P1	1.5V
RS1#	P2	1.5V
HREQ2#	P4	1.5V
HITM#	R1	1.5V
HLOCK#	P5	1.5V
HREQ3#	R2	1.5V
DEFER#	R3	1.5V
BPRI#	T1	1.5V
HREQ0#	R4	1.5V
HREQ1#	T2	1.5V
HREQ4#	R5	1.5V
BNR#	T3	1.5V
HA4#	U1	1.5V
HA7#	T4	1.5V
HA8#	U2	1.5V
HA6#	V1	1.5V
HA9#	U3	1.5V
Length = 55		
Chain 5 Output		
SMAA0	C9	3.3V

NOTES:

- Chain 5 = Odd Number of XOR Gates: All "1s" yields SMAA0 = "0"

Table 26. XOR Chain 6

Pin Name	Ball#	Voltage
HLSTRB#(start)	A20	1.8V
SMD8	A15	3.3V
SMD34	D14	3.3V
SMD9	C14	3.3V
SMD10	B14	3.3V
SMD11	A14	3.3V
SMD36	E13	3.3V
SMD12	D13	3.3V
SMD13	C13	3.3V
SMD14	A13	3.3V
SMD37	E12	3.3V
SMD38	D12	3.3V
SMD41	C12	3.3V
SMD40	B12	3.3V
SMD15	A12	3.3V
SCAS#	A11	3.3V
SMD42	D11	3.3V
SDQM4	B10	3.3V
SMD43	D10	3.3V
SMD44	E10	3.3V
SDQM5	D9	3.3V
SRAS#	D8	3.3V
SMAA7	A7	3.3V
SMAA6	B7	3.3V
SMAB5#	A6	3.3V
SMAB4#	B6	3.3V
SMAA11	A5	3.3V
SMAA9	C6	3.3V
SMAA8	D6	3.3V
SMAA10	D5	3.3V
SBS1	E5	3.3V
SCS3#	C2	3.3V
SDQM7	D2	3.3V
SDQM6	C1	3.3V
SMD59	H4	3.3V

Table 26. XOR Chain 6

Pin Name	Ball#	Voltage
SMD17	F2	3.3V
SMD16	E1	3.3V
SMD23	J4	3.3V
SMD51	H3	3.3V
SMD50	G2	3.3V
SMD49	F1	3.3V
SMD61	J5	3.3V
SMD19	G1	3.3V
SMD31	K4	3.3V
SMD55	J3	3.3V
SMD21	H2	3.3V
SMD62	K5	3.3V
SMD22	H1	3.3V
SMD24	J1	3.3V
SMD27	K3	3.3V
SMD25	K2	3.3V
SMD26	K1	3.3V
Length =53		
Chain 5 Output		
SCS2#	B3	3.3V

NOTES:

1. Chain 6 = Odd Number of XOR Gates: All "1s" yields SCS2# = "1"

Table 27. XOR Chain 7

Pin Name	Ball#	Voltage
HL1 (start)	B23	1.8V
HL3	A23	1.8V
HL2	B22	1.8V
HL0	C21	1.8V
HL8	A22	1.8V
HL9	C20	1.8V
HLSTRB	A21	1.8V
HL4	B19	1.8V
HCOMP	D18	1.8V
HL10	A19	1.8V
HL6	C18	1.8V
HL5	B18	1.8V
HL7	A18	1.8V
SMD0	E17	3.3V
SMD3	D17	3.3V

Table 27. XOR Chain 7

Pin Name	Ball#	Voltage
SMD4	C17	3.3V
SMD32	D16	3.3V
SMD5	A17	3.3V
SMD1	C16	3.3V
SMD33	E15	3.3V
SMD7	B16	3.3V
SMD2	D15	3.3V
SMD6	A16	3.3V
SMD39	B15	3.3V
SMD35	E14	3.3V
length=25		
Chain 7 Output		
SWE#	B11	3.3V

NOTES:

- Chain 7 = Odd Number of XOR Gates: All "1s" yields SWE# = "1"