



LVTTL/TTL-to-Differential LVPECL/PECL Translators

General Description

The MAX9370/MAX9371/MAX9372 LVTTL/TTL-to-differential LVPECL/PECL translators are designed for high-speed communication signal and clock driver applications. The MAX9370/MAX9372 are dual LVTTL/TTL-to-LVPECL/PECL translators that operate in excess of 1GHz. The MAX9371 is a single translator. The MAX9370/MAX9371 operate over a wide 3.0V to 5.25V supply range, allowing high-performance clock or data distribution in systems with a nominal 3.3V or 5.0V supply. The MAX9372 is designed to operate from 3.0V to 3.6V.

The devices default to output high if the input is disconnected. They feature low 270ps propagation delay. The MAX9370/MAX9371/MAX9372 employ industry-standard flow-through pinouts. These devices are specified for operation from -40°C to +85°C, and are offered in space-saving, 8-pin SOT23, μ MAX, and SO packages.

Applications

Precision Clock/Data Level Translation
Central Office Clock Distribution
DSLAM/DLC
Base Station
Mass Storage

Pin Configurations/Functional Diagrams appears at end of data sheet.

Features

- ◆ **Guaranteed 1GHz Operating Frequency at 600mV Differential Output**
- ◆ **270ps Propagation Delay**
- ◆ **10ps Output-to-Output Skew (MAX9370/MAX9372)**
- ◆ **Wide Supply Range: 3.0V to 5.25V (MAX9370/MAX9371)**
- ◆ **ESD Protection > 2kV (Human Body Model)**
- ◆ **Output High with Input Open**
- ◆ **Available in Small 8-Pin SOT23, μ MAX, and SO Packages**
- ◆ **Improved Upgrades to MC100EL22, MC100EPT20, MC100EPT22**

Ordering Information

PART	TEMP RANGE	PIN-PACKAGE
MAX9370EKA-T*	-40°C to +85°C	8 SOT23-8
MAX9370EUA*	-40°C to +85°C	8 μ MAX
MAX9370ESA	-40°C to +85°C	8 SO
MAX9371EKA-T*	-40°C to +85°C	8 SOT23-8
MAX9371EUA*	-40°C to +85°C	8 μ MAX
MAX9371ESA	-40°C to +85°C	8 SO
MAX9372EKA-T*	-40°C to +85°C	8 SOT23-8
MAX9372EUA*	-40°C to +85°C	8 μ MAX
MAX9372ESA	-40°C to +85°C	8 SO

*Future product—contact factory for availability.

Typical Operating Circuit

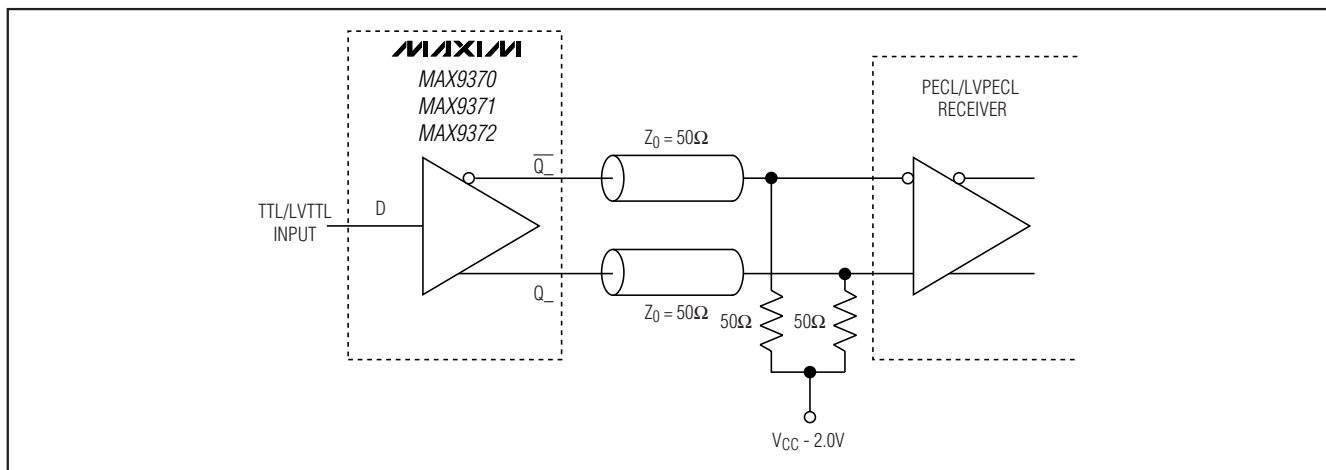

LVTTL/TTL-to-Differential LVPECL/PECL Translators

ABSOLUTE MAXIMUM RATINGS

V _{CC} to GND (MAX9370/MAX9371)	-0.3V to +5.5V	Junction-to-Case Thermal Resistance	
V _{CC} to GND (MAX9372)	-0.3V to +4.0V	8-Pin SOT23	+80°C/W
D ₋ to GND	-0.3V to (V _{CC} + 0.3V)	8-Pin μMAX	+39°C/W
Q ₋ , \bar{Q}_- to GND	-0.3V to (V _{CC} + 0.3V)	8-Pin SO	+40°C/W
Continuous Output Current	50mA	Continuous Power Dissipation (T _A = +70°C)	
Surge Output Current	100mA	8-Pin SO (derate 5.9mW/°C above +70°C)	470mW
Junction-to-Ambient Thermal Resistance in Still Air		8-Pin μMAX (derate 4.5mW/°C above +70°C)	362mW
8-Pin SOT23	+112°C/W	8-Pin SOT23 (derate 8.9mW/°C above +70°C)	714mW
8-Pin μMAX	+221°C/W	Operating Temperature Range	-40°C to +85°C
8-Pin SO	+170°C/W	Junction Temperature	+150°C
Junction-to-Ambient Thermal Resistance with		Storage Temperature Range	-60°C to +150°C
500LFPM Airflow		Soldering Temperature (10s)	+300°C
8-Pin SOT23	+78°C/W		
8-Pin μMAX	+155°C/W		
8-Pin SO	+99°C/W		

Stresses beyond those listed under "Absolute Maximum Ratings" may cause permanent damage to the device. These are stress ratings only, and functional operation of the device at these or any other conditions beyond those indicated in the operational sections of the specifications is not implied. Exposure to absolute maximum rating conditions for extended periods may affect device reliability.

DC ELECTRICAL CHARACTERISTICS

(V_{CC} = 3.0V to 5.25V for MAX9370/MAX9371, V_{CC} = 3.0V to 3.6V for MAX9372, outputs terminated with 50Ω ±1% to V_{CC} - 2.0V. Typical values are at V_{CC} = 3.3V, V_{IH} = 2.4V, V_{IL} = 0.4V, unless otherwise noted.) (Notes 1, 2, 3)

PARAMETER	SYMBOL	CONDITIONS	-40°C			+25°C			+85°C			UNITS
			MIN	TYP	MAX	MIN	TYP	MAX	MIN	TYP	MAX	
LVTTL INPUTS (D₋)												
Input High Voltage	V _{IH}		2.0			2.0			2.0			V
Input Low Voltage	V _{IL}		0.8			0.8			0.8			V
Input Low Current	I _{IL}	V _D = 0.5V	-100			-100			-100			μA
Input High Current	I _{IH}	V _D = 2.7V	-50	+10	-50	+10	-50	+10				μA
		V _D = V _{CC} , MAX9370/MAX9371	130			130			130			
		V _D = V _{CC} , MAX9372	20			20			20			
Input Clamp Voltage		I _{IL} or I _{IH} = 18mA	-1.2			-1.2			-1.2			V
LVPECL/PECL OUTPUTS (Q₋, \bar{Q}_-)												
Output High Voltage	V _{OH}	MAX9370	V _{CC} - 1.085	V _{CC} - 0.895	V _{CC} - 1.025	V _{CC} - 0.895	V _{CC} - 1.025	V _{CC} - 0.895				V
		MAX9371/MAX9372	V _{CC} - 1.145	V _{CC} - 0.895	V _{CC} - 1.145	V _{CC} - 0.895	V _{CC} - 1.145	V _{CC} - 0.895				
Output Low Voltage	V _{OL}	MAX9370	V _{CC} - 1.83	V _{CC} - 1.62	V _{CC} - 1.81	V _{CC} - 1.62	V _{CC} - 1.81	V _{CC} - 1.62				V
		MAX9371/MAX9372	V _{CC} - 1.945	V _{CC} - 1.695	V _{CC} - 1.945	V _{CC} - 1.695	V _{CC} - 1.945	V _{CC} - 1.695				

LVTTL/TTL-to-Differential LVPECL/PECL Translators

MAX9370/MAX9371/MAX9372

DC ELECTRICAL CHARACTERISTICS (continued)

(V_{CC} = 3.0V to 5.25V for MAX9370/MAX9371, V_{CC} = 3.0V to 3.6V for MAX9372, outputs terminated with 50Ω ±1% to V_{CC} - 2.0V. Typical values are at V_{CC} = 3.3V, V_{IH} = 2.4V, V_{IL} = 0.4V, unless otherwise noted.) (Notes 1, 2, 3)

PARAMETER	SYMBOL	CONDITIONS	-40°C			+25°C			+85°C			UNITS
			MIN	TYP	MAX	MIN	TYP	MAX	MIN	TYP	MAX	
Differential Output Swing (V _{OH} - V _{OL})			600			600			600			mV
SUPPLY CURRENT												
Power-Supply Current (Note 4)	I _{CC}	MAX9370/ MAX9372	18 28			20 28			22 28			mA
		MAX9371	9.5 16			10.5 16			11.5 16			

AC ELECTRICAL CHARACTERISTICS

(V_{CC} = 3.0V to 5.25V for MAX9370/MAX9371, V_{CC} = 3.0V to 3.6V for MAX9372, outputs terminated with 50Ω ±1% to V_{CC} - 2.0V, input frequency ≤ 1.0GHz, input transition time = 125ps (20% to 80%), V_{IH} = 2.0V, V_{IL} = 0.8V. Typical values are at V_{CC} = 3.3V, V_{IH} = 2.4V, V_{IL} = 0.4V, unless otherwise noted.) (Note 5)

PARAMETER	SYMBOL	CONDITIONS	-40°C			+25°C			+85°C			UNITS
			MIN	TYP	MAX	MIN	TYP	MAX	MIN	TYP	MAX	
Maximum Toggle Frequency	f _{MAX}	V _{OH} - V _{OL} ≥ 600mV	1.0	1.5		1.0	1.5		1.0	1.5		GHz
Input-to-Output Propagation Delay	t _{PLH} , t _{PHL}	Figure 1	200	270	400	200	270	400	200	270	400	ps
Output-to-Output Skew	t _{SKQQ}	MAX9370/ MAX9372 (Note 6)		10	50		7	50		7	50	ps
Output Rise/Fall Time	t _R , t _F	Figure 1	80		250	80		250	80		250	ps
Added Deterministic Jitter	t _{DJ}	1Gbps 2 ²³ - 1 PRBS pattern (Note 7)		40	60		40	60		40	60	ps(P-P)
Added Random Jitter	t _{RJ}	1GHz clock (Note 7)		0.23	0.8		0.23	0.8		0.23	0.8	ps(RMS)

Note 1: Measurements are made with the device in thermal equilibrium.

Note 2: Current into a pin is defined as positive. Current out of a pin is defined as negative.

Note 3: DC parameters are production tested at T_A = +25°C. DC limits are guaranteed by design and characterization over the full operating temperature range.

Note 4: All pins are open except V_{CC} and GND.

Note 5: Guaranteed by design and characterization. Limits are set to ±6 sigma.

Note 6: Measured between outputs of the same part at the signal crossing points under identical conditions for a same-edge transition.

Note 7: Device jitter added to the input signal.

LVTTL/TTL-to-Differential LVPECL/PECL Translators

Typical Operating Characteristics

(MAX9371, $V_{CC} = 3.3V$, $V_{IH} = 2.4V$, $V_{IL} = 0.4V$, outputs terminated with 50Ω to $V_{CC} - 2V$, input transition time = 125ps (20% to 80%), $T_A = +25^\circ C$, unless otherwise noted.)

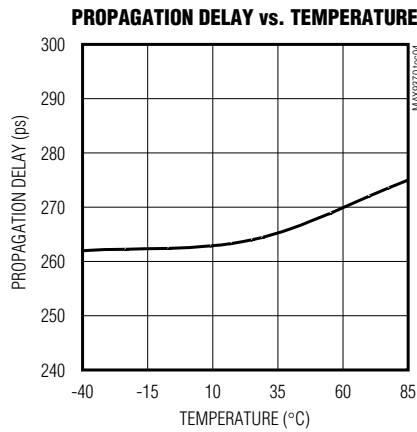
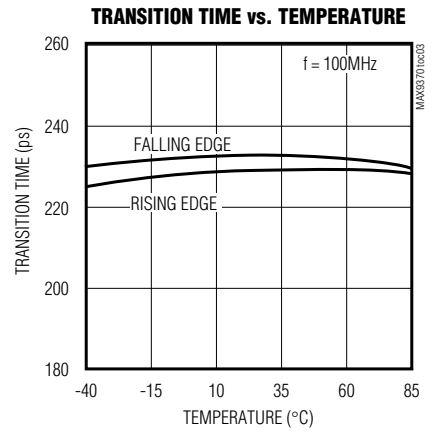
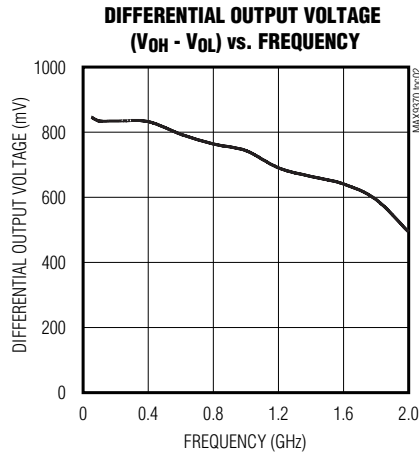
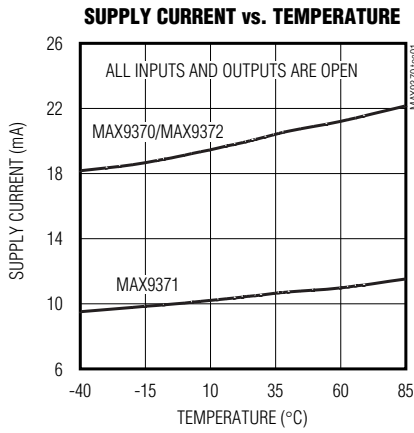

LVTTL/TTL-to-Differential LVPECL/PECL Translators

Pin Description for the MAX9370/MAX9372

PIN		NAME	FUNCTION
SO μ MAX	SOT23		
1	8	Q0	Noninverting Differential LVPECL/PECL Output 0. Typically terminate with 50 Ω resistor to $V_{CC} - 2V$.
2	7	$\overline{Q0}$	Inverting Differential LVPECL/PECL Output 0. Typically terminate with 50 Ω resistor to $V_{CC} - 2V$.
3	6	Q1	Noninverting Differential LVPECL/PECL Output 1. Typically terminate with 50 Ω resistor to $V_{CC} - 2V$.
4	5	$\overline{Q1}$	Inverting Differential LVPECL/PECL Output 1. Typically terminate with 50 Ω resistor to $V_{CC} - 2V$.
5	2	GND	Ground. Provide a low-impedance connection to ground plane.
6	4	D1	LVTTL/TTL Input 1. LVTTL/TTL input for translator corresponding to output Q1 and $\overline{Q1}$.
7	3	D0	LVTTL/TTL Input 0. LVTTL/TTL input for translator corresponding to output Q0 and $\overline{Q0}$.
8	1	V_{CC}	Positive Supply Voltage. Bypass V_{CC} to GND with 0.1 μ F and 0.01 μ F ceramic capacitors. Place the capacitors as close to the device as possible with the smaller value capacitor closest to the device.

Pin Description for the MAX9371

PIN		NAME	FUNCTION
SO μ MAX	SOT23		
1, 4, 6	4, 5, 8	N.C.	No Connection. No internal connection.
2	7	Q	Noninverting Differential LVPECL/PECL Output. Typically terminate with 50 Ω resistor to $V_{CC} - 2V$.
3	6	\overline{Q}	Inverting Differential LVPECL/PECL Output. Typically terminate with 50 Ω resistor to $V_{CC} - 2V$.
5	2	GND	Ground. Provide a low-impedance connection to ground plane.
7	3	D	LVTTL/TTL Input
8	1	V_{CC}	Positive Supply Voltage. Bypass V_{CC} to GND with 0.1 μ F and 0.01 μ F ceramic capacitors. Place the capacitors as close to the device as possible with the smaller value capacitor closest to the device.

Detailed Description

The MAX9370/MAX9371/MAX9372 LVTTL/TTL-to-differential LVPECL/PECL translators are designed for high-speed communication signal and clock driver applications. The MAX9370/MAX9372 are dual LVTTL-to-LVPECL/PECL translators that operate in excess of 1GHz. The MAX9371 is a single translator. The MAX9370/MAX9371 operate over a wide 3.0V to 5.25V supply range, allowing high-performance clock or data distribution in systems with a nominal 3.3V or 5.0V supply. The MAX9372 is optimized for 3.0V to 3.6V operation. These devices feature low 270ps propagation delay and 40ps peak-to-peak deterministic jitter.

Inputs and Outputs

The MAX9370/MAX9371/MAX9372 inputs accept standard LVTTL/TTL levels. The input has pullup circuitry that drives the outputs to a differential high if the inputs are open. The outputs are differential LVPECL/PECL levels.

Applications Information

Output Termination

Terminate outputs with 50 Ω to $V_{CC} - 2V$ or use an equivalent Thevenin termination. Use the same terminate on each output for the lowest output-to-output skew. When a single-ended signal is taken from a differential output, terminate both outputs. For example, if Q is used as a single-ended output, terminate both Q and \overline{Q} .

LVTTTL/TTL-to-Differential LVPECL/PECL Translators

Ensure that the output currents do not exceed the continuous safe output current limit or surge output current limit as specified in the *Absolute Maximum Ratings* table. Under all operating conditions, the device's total thermal limits should be observed.

Supply Bypassing

Bypass V_{CC} to GND with high-frequency surface-mount ceramic $0.1\mu\text{F}$ and $0.01\mu\text{F}$ capacitors in parallel and as close to the device as possible, with the $0.01\mu\text{F}$ capacitor closest to the device. Use multiple parallel vias to minimize parasitic inductance.

PC Board Traces

Input and output trace characteristics affect the performance of the MAX9370/MAX9371/MAX9372. Connect each differential output to a 50Ω characteristic impedance trace. Minimize the number of vias to prevent impedance discontinuities. Reduce reflections by maintaining the 50Ω characteristic impedance through connectors and across cables. Reduce skew within a differential pair by matching the electrical length of the traces.

Chip Information

TRANSISTOR COUNT: 358

PROCESS: Bipolar

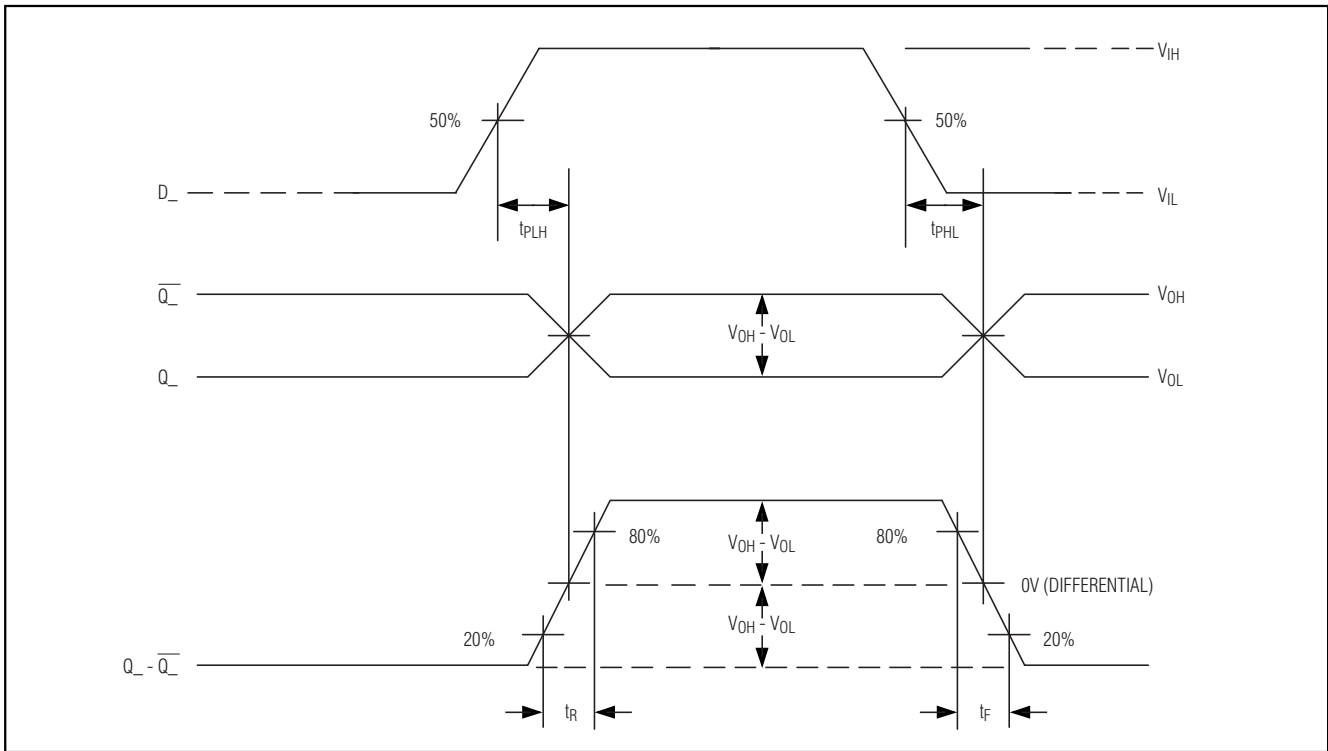
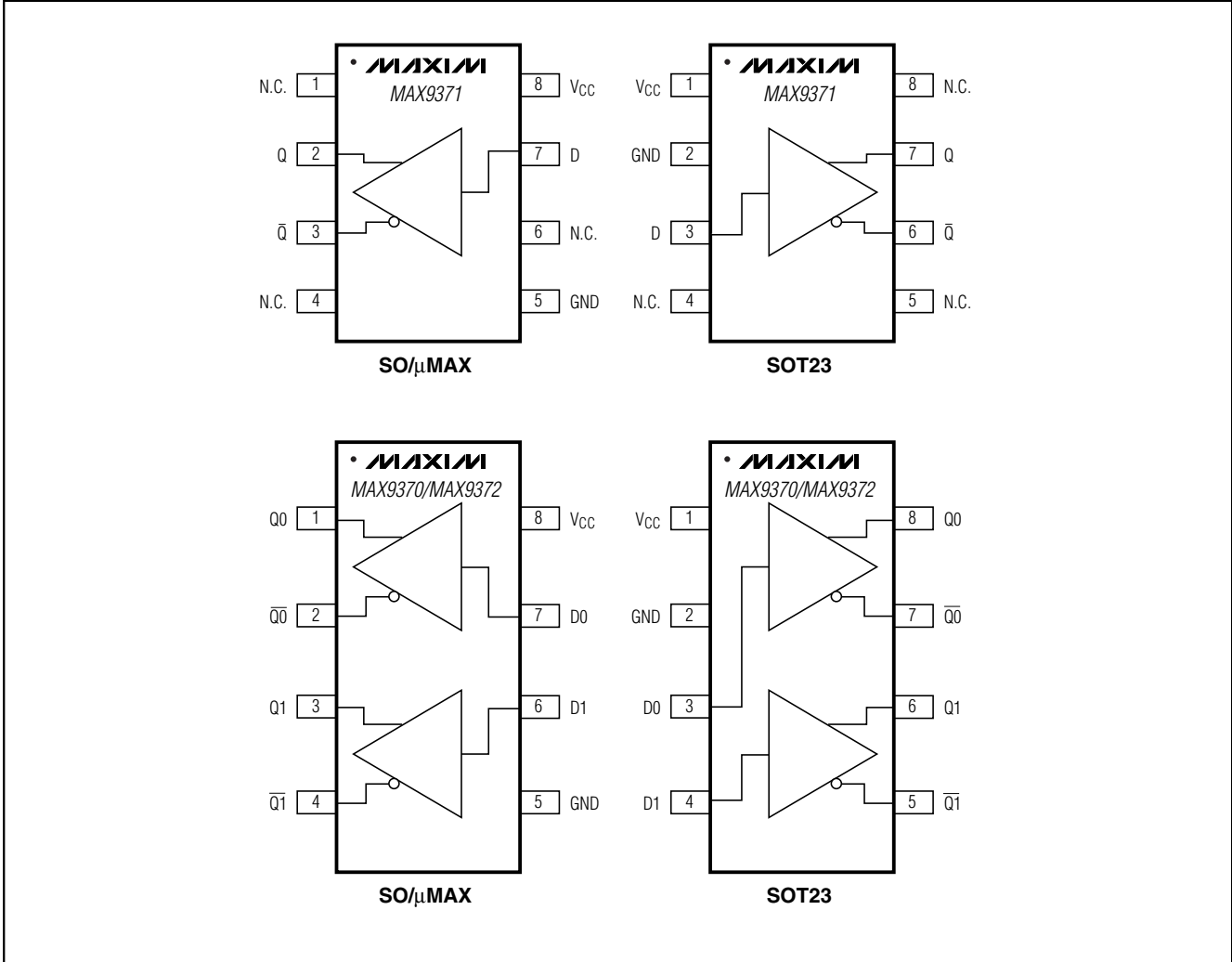

Figure 1. Input-to-Output Propagation Delay and Transition Timing Diagram

LVTTL/TTL-to-Differential LVPECL/PECL Translators

Pin Configurations/Functional Diagrams

MAX9370/MAX9371/MAX9372



LVTTTL/TTL-to-Differential LVPECL/PECL Translators

Package Information

(The package drawing(s) in this data sheet may not reflect the most current specifications. For the latest package outline information, go to www.maxim-ic.com/packages.)

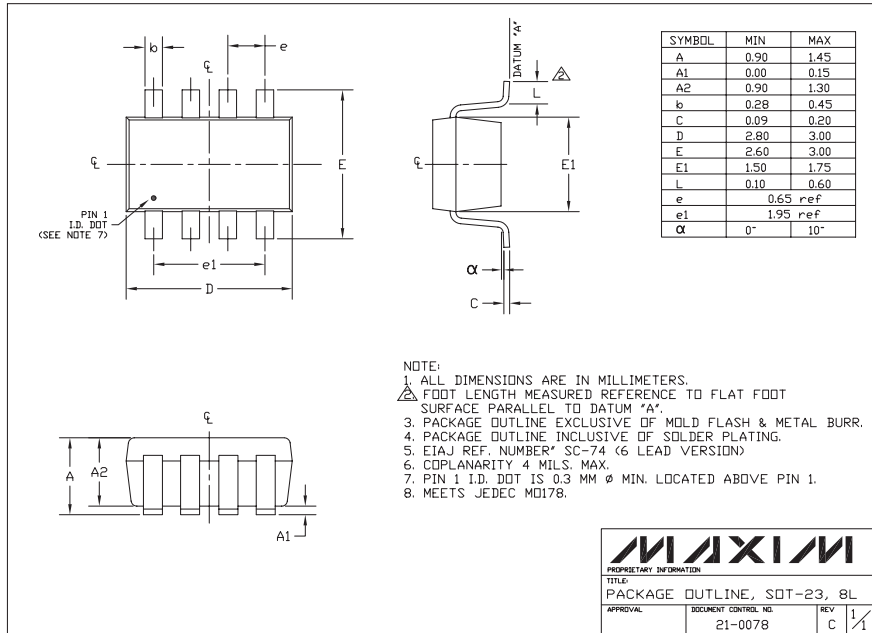

SOT23-8LEPS

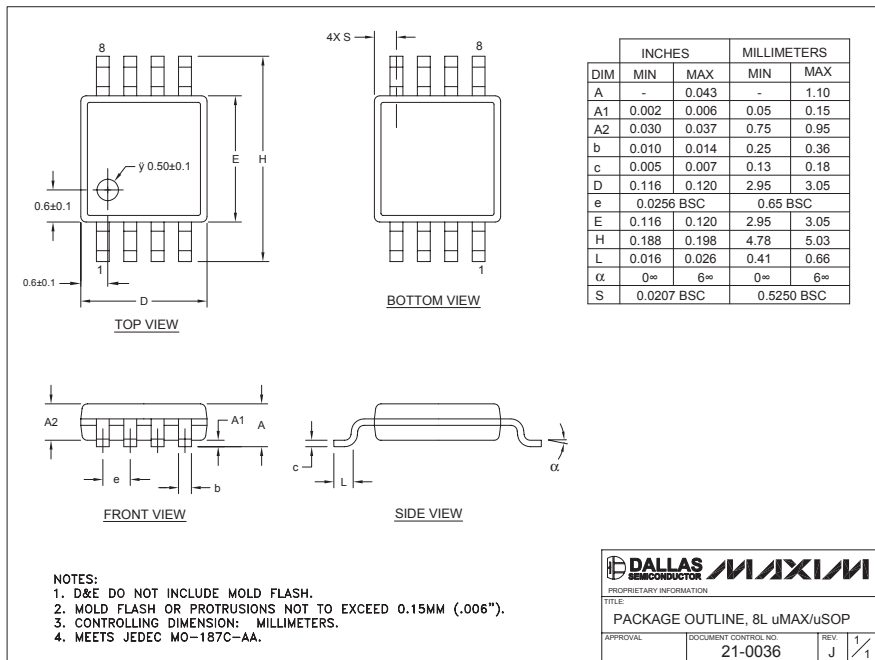

8L uMAX uSOP

LVTTTL/TTL-to-Differential LVPECL/PECL Translators

Package Information (continued)

(The package drawing(s) in this data sheet may not reflect the most current specifications. For the latest package outline information, go to www.maxim-ic.com/packages.)

MAX9370/MAX9371/MAX9372

9LUCSP, 3x3EFS

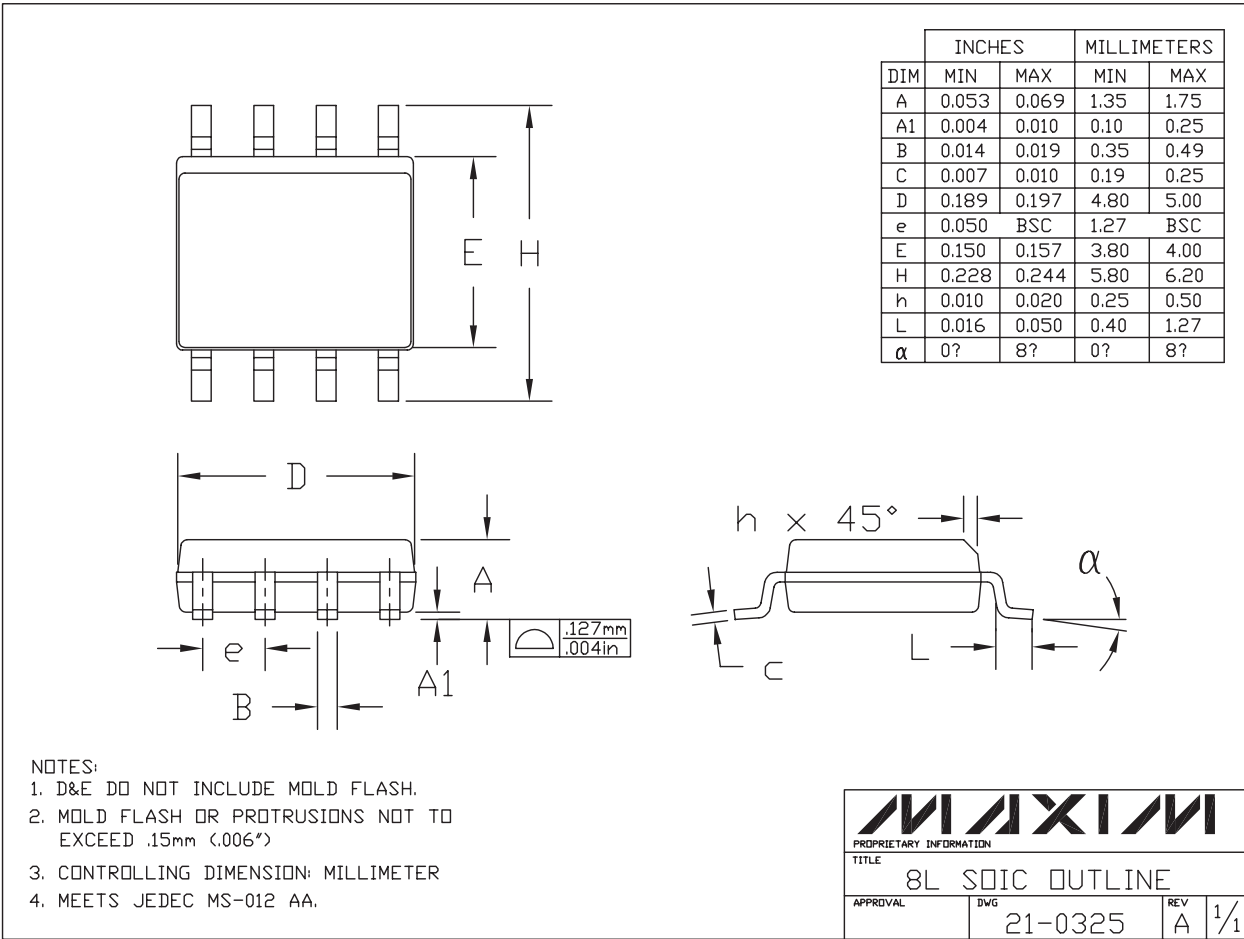

Maxim cannot assume responsibility for use of any circuitry other than circuitry entirely embodied in a Maxim product. No circuit patent licenses are implied. Maxim reserves the right to change the circuitry and specifications without notice at any time.

Maxim Integrated Products, 120 San Gabriel Drive, Sunnyvale, CA 94086 408-737-7600 _____ 9