



# FAN54053

## High Efficiency, 1.55 A, Li-Ion Switching Charger with Power Path, USB-OTG, in a Small Solution Footprint

### Features

- Fully Integrated, High-Efficiency Switch-Mode Charger for Single-Cell Li-Ion and Li-Polymer Batteries
- Power Path Circuit Ensures Fast System Startup with a Dead Battery when VBUS is Connected
- 1.55 A Maximum Charge Current
- Programmable High Accuracy Float Voltage:
  - $\pm 0.5\%$  at 25°C
  - $\pm 1\%$  from 0 to 125°C
- $\pm 5\%$  Input and Charge Current Regulation Accuracy
- Temperature-Sense Input for JEITA Compliance
- Thermal Regulation and Shutdown
- 4.2 V at 2.3 A Production Test Support
- 5 V, 500 mA Boost Mode for USB OTG
- 28 V Absolute Maximum Input Voltage
- 6 V Maximum Input Operating Voltage
- Programmable through High-Speed I<sup>2</sup>C Interface (3.4 Mb/s) with Fast Mode Plus Compatibility
  - Input Current
  - Fast-Charge / Termination Current
  - Float Voltage
  - Termination Enable
- 3 MHz Synchronous Buck PWM Controller with Wide Duty Cycle Range
- Small Footprint 1  $\mu$ H External Inductor
- Safety Timer with Reset Control
- Dynamic Input Voltage Control
- Very Low Battery Current when Charger Inactive

### Applications

- Cell Phones, Smart Phones, PDAs
- Tablet, Portable Media Players
- Gaming Device, Digital Cameras

All trademarks are the property of their respective owners.

### Description

The FAN54053 is a 1.55 A USB-compliant switch-mode charger featuring power path operation, USB OTG boost support, JEITA temperature control, and production test mode support, in a small 25 bump, 0.4 mm pitch WLCSP package.

To facilitate fast system startup, the IC includes a power path circuit, which disconnects the battery from the system rail, ensuring that the system can power up quickly following a VBUS connection. The power path circuit ensures that the system rail stays up when the charger is plugged in, even if the battery is dead or shorted.

The charging parameters; float voltage, input voltage regulation, input current, charging current, and other operating modes are programmable through an I<sup>2</sup>C Interface that operates up to 3.4 Mbps. The charger and boost regulator circuits switch at 3 MHz to minimize the size of external passive components.

The FAN54053 provides battery charging in three phases: conditioning, constant current and constant voltage. The IC automatically restarts the charge cycle when the battery falls below a voltage threshold. If the input source is removed, the IC enters a high-impedance mode blocking battery current from leaking to the input. Charge status is reported back to the host through the I<sup>2</sup>C port.

Dynamic input voltage control prevents a weak adapter's voltage from collapsing, ensuring charging capability from such adapters.

The FAN54053 is available in a space saving 2.4 mm x 2.0 mm WLCSP package.

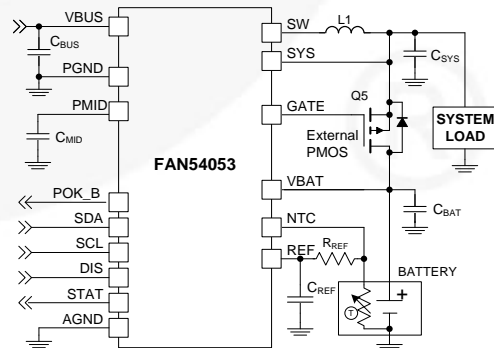

Figure 1. Typical Application

## Ordering Information

Part Number	Temperature Range	Package	PN Bits: IC_INFO[5:3]	Packing Method
FAN54053UCX	-40 to 85°C	25-Bump, Wafer-Level Chip-Scale Package (WLCSP), 0.4 mm Pitch	010	Tape and Reel

**Table 1. Feature Summary**

Part Number	Slave Address	Automatic Charge	Battery Absent Behavior	E1 Pin	Watchdog Timer Default
FAN54053	1101011	No	On	POK_B	Disabled

## Block Diagram

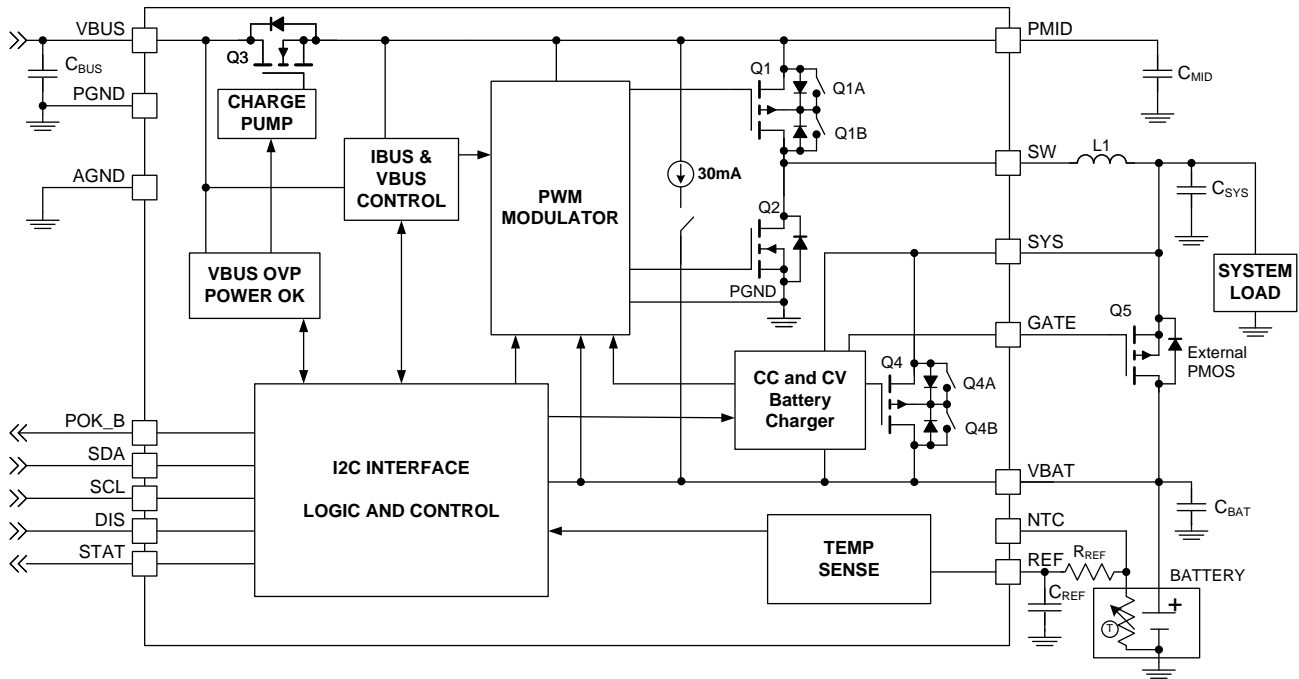

<b>PMID</b>	<b>Q1A</b>	<b>Q1B</b>	<b>SYS</b>	<b>Q4A</b>	<b>Q4B</b>
Greater than $V_{BAT}$	ON	OFF	Greater than $V_{BAT}$	ON	OFF
Less than $V_{BAT}$	OFF	ON	Less than $V_{BAT}$	OFF	ON

**Figure 2. IC and System Block Diagram**

**Table 2. Recommended External Components**

Component	Description	Vendor	Parameter	Typ.	Unit
L1	1 $\mu$ H, 20%, 2.7 A, 2016	Toko DFE201610E-1R0M or Equivalent	L	1.0	$\mu$ H
			DCR (Series R)	48	m $\Omega$
$C_{BAT}, C_{SYS}$	10 $\mu$ F, 20%, 6.3 V, X5R, 0603	Murata: GRM188R60J106M TDK: C1608X5R0J106M	C	10	$\mu$ F
$C_{MID}$	4.7 $\mu$ F, 10%, 10 V, X5R, 0603	Murata: GRM188R61A475K TDK: C1608X5R1A475K	$C^{(1)}$	4.7	$\mu$ F
$C_{BUS}$	1.0 $\mu$ F, 10%, 25 V, X5R, 0603	Murata GRM188R61E105K TDK:C1608X5R1E105M	C	1.0	$\mu$ F
Q5	PMOS, 12 V, 16 m $\Omega$ , MLP2x2	Fairchild FDMA905P	$R_{DS(ON)}$	16	m $\Omega$
$C_{REF}$	1 $\mu$ F, 10%, 6.3 V, X5R, 0402		C	1.0	$\mu$ F

**Note:**

- 10 V rating is sufficient for  $C_{MID}$  since PMID is protected from over-voltage surges on VBUS by Q3.

## Pin Configuration

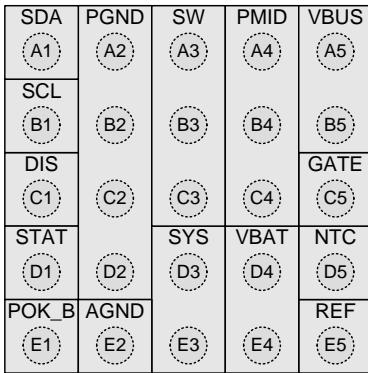

Figure 3. Top View

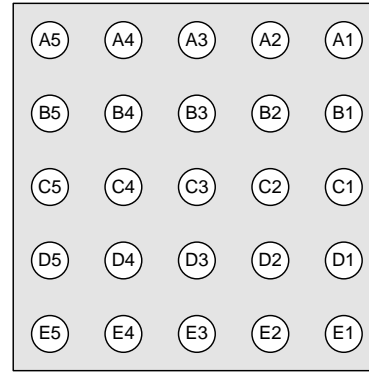

Figure 4. Bottom View

## Pin Definitions

Pin #	Name	Description
A1	SDA	<b>I<sup>2</sup>C Interface Serial Data.</b> This pin should not be left floating.
B1	SCL	<b>I<sup>2</sup>C Interface Serial Clock.</b> This pin should not be left floating.
C1	DIS	<b>Disable.</b> If this pin is held HIGH, Q1 and Q3 are turned off, creating a HIGH Z condition at VBUS and the PWM converter is disabled.
D1	STAT	<b>Status.</b> Open-drain output indicating charge status. The IC pulls this pin LOW when charge is in progress; can be used to signal the host processor when a fault condition occurs.
E1	POK_B	<b>Power OK.</b> Open-drain output that pulls LOW when VBUS is plugged in and the battery has risen above $V_{LOWV}$ . This signal is used to signal the host processor that it can begin to draw significant current.
A2 – D2	PGND	<b>Power Ground.</b> Power return for gate drive and power transistors. The connection from this pin to the bottom of $C_{MID}$ should be as short as possible.
E2	AGND	<b>Analog Ground.</b> All IC signals are referenced to this node.
A3 – C3	SW	<b>Switching Node.</b> Connect to output inductor.
D3 – E3	SYS	<b>System Supply.</b> Output voltage of the switching charger and input to the power path controller. Bypass SYS to PGND with a 10 $\mu$ F capacitor.
A4 – C4	PMID	<b>Power Input Voltage.</b> Power input to the charger regulator, bypass point for the input current sense. Bypass with a minimum of a 4.7 $\mu$ F, 6.3 V capacitor to PGND.
D4 – E4	VBAT	<b>Battery Voltage.</b> Connect to the positive (+) terminal of the battery pack. Bypass with a 10 $\mu$ F capacitor to PGND. VBAT is a power path connection.
A5 – B5	VBUS	<b>Charger Input Voltage</b> and USB-OTG output voltage. Bypass with a 1 $\mu$ F capacitor to PGND.
C5	GATE	<b>External MOSFET Gate.</b> This pin controls the gate of an external P-channel MOSFET transistor used to augment the internal ideal diode. The source of the P-channel MOSFET should be connected to SYS and the drain should be connected to VBAT.
D5	NTC	<b>Thermistor input.</b> The IC compares this node with taps on a resistor divider from REF to inhibit auto-charging when the battery temperature is outside of permitted fast-charge limits.
E5	REF	<b>Reference Voltage.</b> REF is a 1.8 V regulated output.

## Absolute Maximum Ratings

Stresses exceeding the absolute maximum ratings may damage the device. The device may not function or be operable above the recommended operating conditions and stressing the parts to these levels is not recommended. In addition, extended exposure to stresses above the recommended operating conditions may affect device reliability. The absolute maximum ratings are stress ratings only.

Symbol	Parameter		Min.	Max.	Unit	
V <sub>BUS</sub>	Voltage on VBUS Pin	Continuous	-0.3	28.0	V	
		Pulsed, 100 ms Maximum Non-Repetitive	-1.0			
V <sub>I</sub>	Voltage on PMID Voltage Pin		-0.3	7.0	V	
	Voltage on SW, SYS, VBAT, STAT, DIS Pins		-0.3	7.0		
V <sub>O</sub>	Voltage on Other Pins		-0.3	6.5 <sup>(2)</sup>	V	
$\frac{dV_{BUS}}{dt}$	Maximum V <sub>BUS</sub> Slope Above 5.5 V when Boost or Charger Active			4	V/ $\mu$ s	
ESD	Electrostatic Discharge Protection Level <sup>(3)</sup>	Human Body Model per JESD22-A114	2000		V	
		Charged Device Model per JESD22-C101	500			
	IEC 61000-4-2 System ESD	USB Connector Pins (V <sub>BUS</sub> to GND)	Air Gap	15		kV
			Contact	8		
T <sub>J</sub>	Junction Temperature		-40	+150	°C	
T <sub>STG</sub>	Storage Temperature		-65	+150	°C	
T <sub>L</sub>	Lead Soldering Temperature, 10 Seconds			+260	°C	

### Notes:

- Lesser of 6.5 V or V<sub>I</sub> + 0.3 V.
- Guaranteed if C<sub>BUS</sub> ≥ 1  $\mu$ F and C<sub>MID</sub> ≥ 4.7  $\mu$ F.

## Recommended Operating Conditions

The Recommended Operating Conditions table defines the conditions for actual device operation. Recommended operating conditions are specified to ensure optimal performance to the datasheet specifications. Fairchild does not recommend exceeding them or designing to absolute maximum ratings.

Symbol	Parameter		Min.	Max.	Unit
V <sub>BUS</sub>	Supply Voltage		4	6	V
V <sub>BAT(MAX)</sub>	Maximum Battery Voltage when Boost enabled			4.5	V
$\frac{dV_{BUS}}{dt}$	Negative VBUS Slew Rate during VBUS Short Circuit, C <sub>MID</sub> ≤ 4.7 $\mu$ F, see <i>VBUS Short While Charging</i>	T <sub>A</sub> ≤ 60°C		4	V/ $\mu$ s
		T <sub>A</sub> ≥ 60°C		2	
T <sub>A</sub>	Ambient Temperature		-30	+85	°C
T <sub>J</sub>	Junction Temperature (see <i>Register Bit section</i> )		-30	+120	°C

## Thermal Properties

Junction-to-ambient thermal resistance is a function of application and board layout. This data is measured with four-layer 2s2p boards in accordance to JEDEC standard JESD51. Special attention must be paid not to exceed junction temperature T<sub>J(max)</sub> at a given ambient temperature T<sub>A</sub>.

Symbol	Parameter		Typical	Unit
$\theta_{JA}$	Junction-to-Ambient Thermal Resistance		50	°C/W
$\theta_{JB}$	Junction-to-PCB Thermal Resistance		20	°C/W

## Electrical Specifications

Unless otherwise specified: according to the circuit of Figure 1; recommended operating temperature range for  $T_J$  and  $T_A$ ;  $V_{BUS}=5.0$  V;  $HZ\_MODE="0"$ ;  $OPA\_MODE="0"$  (Charge Mode); SCL, SDA=0 or 1.8 V; and typical values are for  $T_J=25^\circ\text{C}$ . Min. and Max. values are not tested in production, but are determined by characterization.

Symbol	Parameter	Conditions	Min.	Typ.	Max.	Unit	
<b>Power Supplies</b>							
$I_{VBUS}$	VBUS Current	PWM Switching		25		mA	
		$V_{BAT} > V_{OREG}$ $I_{BUSLIM} = 500$ mA		6		mA	
		$0^\circ\text{C} < T_J < 85^\circ\text{C}$ , $HZ\_MODE = "1"$ , $V_{BAT} > V_{LOWV}$		190	280	$\mu\text{A}$	
$I_{BAT\_HZ}$	Battery Discharge Current in High-Impedance Mode	DIS pin HIGH, or $HZ\_MODE = "1"$ , $V_{BAT}=4.35$ V		<1.25	10	$\mu\text{A}$	
$I_{BUS\_HZ}$	Battery Leakage Current to $V_{BUS}$ in High-Impedance Mode	DIS pin HIGH, or $HZ\_MODE = "1"$ , $V_{BUS}$ Shorted to Ground, $V_{BAT}=4.35$ V	-5.0	-0.2		$\mu\text{A}$	
<b>Charger Voltage Regulation</b>							
$V_{OREG}$	Charge Voltage Range		3.51		4.45	V	
	Charge Voltage Accuracy	$T_A = 25^\circ\text{C}$ , $V_{OREG} = 4.35$ V	-0.5		+0.5	%	
		$T_J=0$ to $125^\circ\text{C}$	-1		+1	%	
<b>Charging Current Regulation (Fast Charge)</b>							
$I_{OCHRG}$	Output Charge Current Range	$V_{LOWV} < V_{BAT} < V_{OREG}$	IO_LEVEL = "0"	550		1550	mA
			IO_LEVEL = "1" (default)	165	200	230	mA
	Charge Current Accuracy	IO_LEVEL = "0"	-5		+5	%	
<b>Weak Battery Detection</b>							
$V_{LOWV}$	Weak Battery Threshold Range		3.35		3.75	V	
	Weak Battery Threshold Accuracy		-5		+5	%	
	Weak Battery Deglitch Time	Rising Voltage, 2 mV Overdrive		32		ms	
<b>PWM Charging Threshold</b>							
$V_{BATMIN}$	Rising PWM Charging Threshold		3.1	3.2	3.3	V	
$V_{BATFALL}$	Falling PWM Charging Threshold			3.0		V	
<b>Logic Levels: DIS, SDA, SCL</b>							
$V_{IH}$	High-Level Input Voltage		1.05			V	
$V_{IL}$	Low-Level Input Voltage				0.4	V	
$I_{IN}$	Input Bias Current	Input Tied to GND or $V_{BUS}$		0.01	1.00	$\mu\text{A}$	
$R_{PD}$	DIS Pull-Down Resistance			1		$\text{M}\Omega$	
<b>Charge Termination Detection</b>							
$I_{(TERM)}$	Termination Current Range	$V_{BAT} > V_{OREG} - V_{RCH}$ , $V_{BUS} > V_{SLP}$	50		400	mA	
	Termination Current Accuracy	$I_{TERM}$ Setting $\leq 100$ mA	-15		+15	%	
		$I_{TERM}$ Setting $\geq 200$ mA	-5		+5	%	
	Termination Current Deglitch Time <sup>(4)</sup>			32		ms	

### Electrical Specifications (Continued)

Unless otherwise specified: according to the circuit of Figure 1; recommended operating temperature range for  $T_J$  and  $T_A$ ;  $V_{BUS}=5.0$  V;  $HZ\_MODE="0"$ ;  $OPA\_MODE="0"$  (Charge Mode);  $SCL, SDA=0$  or 1.8 V; and typical values are for  $T_J=25^\circ\text{C}$ . Min. and Max. values are not tested in production, but are determined by characterization.

Symbol	Parameter	Conditions	Min.	Typ.	Max.	Unit
<b>Power Path (Q4) Control (Precharge)</b>						
$I_{PP}$	Power Path Maximum Charge Current	$IO\_LEVEL = "1"$ (default)	165	200	235	mA
		$IO\_LEVEL = "0", I_{BUSLIM} \leq "01"$	165	200	235	mA
		$IO\_LEVEL = "0", I_{BUSLIM} > "01", I_{OCHARGE} \leq "02"$	375	450	520	mA
		$IO\_LEVEL = "0", I_{BUSLIM} > "01", I_{OCHARGE} > "02"$	610	730	840	mA
$V_{THSYS}$	VBAT to SYS Threshold for Q4 and Gate Transition While Charging	(SYS-VBAT) Falling	-6	-5	-3	mV
		(SYS-VBAT) Rising	-1	+1	2	mV
<b>Production Test Mode</b>						
$V_{BAT(PTM)}^{(4)}$	Production Test Output Voltage	$1\text{ mA} < I_{BAT} < 2\text{ A}, V_{BUS}=5.5\text{ V}$	4.116	4.200	4.284	V
$I_{BAT(PTM)}^{(4)}$	Production Test Output Current	20% Duty with Max. Period 10 ms	2.3			A
<b>Battery Temperature Monitor (NTC)</b>						
T1	T1 (0°C) Temperature Threshold		71.9	73.9	75.9	% of $V_{REF}$
T2	T2 (10°C) Temperature Threshold		62.6	64.6	66.6	
T3	T3 (45°C) Temperature Threshold		31.9	32.9	34.9	
T4	T4 (60°C) Temperature Threshold		21.3	23.3	25.3	
<b>Input Power Source Detection</b>						
$V_{IN(MIN)1}$	VBUS Input Voltage Rising	To Initiate and Pass VBUS Validation		4.35	4.45	V
$V_{IN(MIN)2}$	Minimum VBUS during Charge	During Charging		3.71	3.94	V
$t_{VBUS\_VALID}^{(4)}$	VBUS Validation Time			30		ms
<b>VBUS Control Loop</b>						
$V_{BUSLIM}$	VBUS Loop Setpoint Accuracy		-3		+3	%
<b>Input Current Limit</b>						
$I_{BUSLIM}$	Charger Input Current Limit Threshold	$I_{BUSLIM} = "00"$	450	475	500	mA
		$I_{BUSLIM} = "01"$		760		
		$I_{BUSLIM} = "10"$	972	1080	1188	
<b><math>V_{REF}</math> Bias Generator</b>						
$V_{REF}$	Bias Regulator Voltage	$V_{BUS} > V_{IN(MIN)1}$		1.8		V
	Short-Circuit Current Limit			2.5		mA
<b>Battery Recharge Threshold</b>						
$V_{RCH}$	Recharge Threshold	Below $V_{OREG}$	100	120	150	mV
	Deglitch Time	$V_{BAT}$ Falling Below $V_{RCH}$ Threshold		130		ms
<b>STAT, POK_B Output</b>						
$V_{STAT(OL)}$	STAT Output Low	$I_{STAT} = 10\text{ mA}$			0.4	V
$I_{STAT(OH)}$	STAT High Leakage Current	$V_{STAT} = 5\text{ V}$			1	$\mu\text{A}$

**Electrical Specifications** (Continued)

Unless otherwise specified: according to the circuit of Figure 1; recommended operating temperature range for  $T_J$  and  $T_A$ ;  $V_{BUS}=5.0\text{ V}$ ;  $HZ\_MODE="0"$ ;  $OPA\_MODE="0"$  (Charge Mode); SCL, SDA=0 or 1.8 V; and typical values are for  $T_J=25^\circ\text{C}$ . Min. and Max. values are not tested in production, but are determined by characterization.

Symbol	Parameter	Conditions	Min.	Typ.	Max.	Unit
<b>Battery Detection</b>						
$I_{DETECT}$	Battery Detection Current before Charge Done (Sink Current) <sup>(5)</sup>	Begins after Termination Detected and $V_{BAT} \leq V_{OREG} - V_{RCH}$		-1.9		mA
$t_{DETECT}$	Battery Detection Time			262		ms
<b>Sleep Comparator</b>						
$V_{SLP}$	Sleep-Mode Entry Threshold, $V_{BUS} - V_{BAT}$	$2.3\text{ V} \leq V_{BAT} \leq V_{OREG}$ , $V_{BUS}$ Falling	0	0.04	0.10	V
<b>Power Switches</b> (see Figure 2)						
$R_{DS(ON)}$	Q3 On Resistance (VBUS to PMID)	$I_{IN(LIMIT)} = 500\text{ mA}$		180	400	m $\Omega$
	Q1 On Resistance (PMID to SW)			130	225	
	Q2 On Resistance (SW to GND)			150	225	
	Q4 On Resistance (SYS to VBAT)	$V_{BAT}=4.35\text{ V}$		70	100	m $\Omega$
$I_{SYNC}$	Synchronous to Non-Synchronous Current Cut-Off Threshold <sup>(6)</sup>	Low-Side MOSFET (Q2) Cycle-by-Cycle Current Limit		180		mA
<b>Charger PWM Modulator</b>						
$f_{SW}$	Oscillator Frequency		2.7	3.0	3.3	MHz
$D_{MAX}$	Maximum Duty Cycle				100	%
$D_{MIN}$	Minimum Duty Cycle			0		%
<b>Boost Mode Operation (OPA_MODE=1)</b>						
$V_{BOOST}$	Boost Output Voltage at VBUS	$2.5\text{ V} < V_{BAT} < 4.5\text{ V}$ , $I_{LOAD}$ from 0 to 200 mA	4.80	5.07	5.20	V
		$3.0\text{ V} < V_{BAT} < 4.5\text{ V}$ , $I_{LOAD}$ from 0 to 500 mA	4.77	5.07	5.20	
$I_{BAT(BOOST)}$	Boost Mode Quiescent Current	PFM Mode, $V_{BAT} = 3.6\text{ V}$ , $I_{LOAD} = 0\text{ A}$		250	350	$\mu\text{A}$
$I_{LIMPK(BST)}$	Q2 Peak Current Limit		1350	1550	1950	mA
$UVLO_{BST}$	Minimum Battery Voltage for Boost Operation	While Boost Active		2.32		V
		To Start Boost Regulator		2.48	2.70	
<b>VBUS Load Resistance</b>						
$R_{VBUS}$	VBUS to PGND Resistance	Normal Operation		500		k $\Omega$
		VBUS Validation		100		$\Omega$
<b>Protection and Timers</b>						
$V_{BUS(OVP)}$	VBUS Over-Voltage Shutdown	$V_{BUS}$ Rising	6.09	6.29	6.49	V
	Hysteresis	$V_{BUS}$ Falling		100		mV
$I_{LIMPK(CHG)}$	Q1 Cycle-by-Cycle Peak Current Limit	Charge Mode		3		A
$V_{SHORT}$	Battery Short-Circuit Threshold	$V_{BAT}$ Rising	1.95	2.00	2.07	V
	Hysteresis			100		mV
$I_{SHORT}$	Linear Charging Current	$V_{BAT} < V_{SHORT}$		30		mA
$T_{SHUTDOWN}$	Thermal Shutdown Threshold <sup>(4)</sup>	$T_J$ Rising		145		$^\circ\text{C}$
	Hysteresis <sup>(4)</sup>	$T_J$ Falling		25		
$T_{CF}$	Thermal Regulation Threshold <sup>(4)</sup>	Charge Current Reduction Begins		120		$^\circ\text{C}$
$t_{INT}$	Detection Interval			2.1		s

**Electrical Specifications** (Continued)

Unless otherwise specified: according to the circuit of Figure 1; recommended operating temperature range for  $T_J$  and  $T_A$ ;  $V_{BUS}=5.0$  V;  $HZ\_MODE$ ;  $OPA\_MODE=0$ ; (Charge Mode);  $SCL$ ,  $SDA=0$  or 1.8 V; and typical values are for  $T_J=25^\circ\text{C}$ . Min. and Max. values are not tested in production, but are determined by characterization.

Symbol	Parameter	Conditions	Min.	Typ.	Max.	Unit
$t_{32S}$	32-Second Timer <sup>(7)</sup>	Charger Enabled	20.5	25.2	28.0	s
		Charger Disabled	18.0	25.2	34.0	
$t_{15MIN}$	15-Minute Timer	15-Minute Mode	12.0	13.5	15.0	min
$\Delta t_{LF}$	Low-Frequency Timer Accuracy	Charger Inactive	-23		27	%

**Notes:**

- Guaranteed by design; not tested in production.
- Negative current is current flowing from the battery to VBUS (discharging the battery).
- Q2 always turns on for 60 ns, then turns off if current is below  $I_{SYNC}$ .
- This tolerance (%) applies to all timers on the IC, including soft-start and deglitching timers.



## I<sup>2</sup>C Timing Specifications

Guaranteed by design.

Symbol	Parameter	Conditions	Min.	Typ.	Max.	Unit
f <sub>SCL</sub>	SCL Clock Frequency	Standard Mode			100	kHz
		Fast Mode			400	
		Fast Mode Plus			1000	
		High-Speed Mode, C <sub>B</sub> ≤ 100 pF			3400	
		High-Speed Mode, C <sub>B</sub> ≤ 400 pF			1700	
t <sub>BUF</sub>	BUS-free Time between STOP and START Conditions	Standard Mode		4.7		μs
		Fast Mode		1.3		
		Fast Mode Plus		0.5		
t <sub>HD,STA</sub>	START or Repeated START Hold Time	Standard Mode		4		μs
		Fast Mode		600		ns
		Fast Mode Plus		260		ns
		High-Speed Mode		160		ns
t <sub>LOW</sub>	SCL LOW Period	Standard Mode		4.7		μs
		Fast Mode		1.3		μs
		Fast Mode Plus		0.5		μs
		High-Speed Mode, C <sub>B</sub> ≤ 100 pF		160		ns
		High-Speed Mode, C <sub>B</sub> ≤ 400 pF		320		ns
t <sub>HIGH</sub>	SCL HIGH Period	Standard Mode		4		μs
		Fast Mode		600		ns
		Fast Mode Plus		260		ns
		High-Speed Mode, C <sub>B</sub> ≤ 100 pF		60		ns
		High-Speed Mode, C <sub>B</sub> ≤ 400 pF		120		ns
t <sub>SU,STA</sub>	Repeated START Setup Time	Standard Mode		4.7		μs
		Fast Mode		600		ns
		Fast Mode Plus		260		ns
		High-Speed Mode		160		ns
t <sub>SU,DAT</sub>	Data Setup Time	Standard Mode		250		ns
		Fast Mode		100		
		Fast Mode Plus		50		
		High-Speed Mode		10		
t <sub>HD,DAT</sub>	Data Hold Time	Standard Mode	0		3.45	μs
		Fast Mode	0		900	ns
		Fast Mode Plus	0		450	ns
		High-Speed Mode, C <sub>B</sub> ≤ 100 pF	0		70	ns
		High-Speed Mode, C <sub>B</sub> ≤ 400 pF	0		150	ns
t <sub>RCL</sub>	SCL Rise Time	Standard Mode	20+0.1C <sub>B</sub>		1000	ns
		Fast Mode	20+0.1C <sub>B</sub>		300	
		Fast Mode Plus	20+0.1C <sub>B</sub>		120	
		High-Speed Mode, C <sub>B</sub> ≤ 100 pF		10	80	
		High-Speed Mode, C <sub>B</sub> ≤ 400 pF		20	160	

**I<sup>2</sup>C Timing Specifications** (Continued)

Guaranteed by design.

Symbol	Parameter	Conditions	Min.	Typ.	Max.	Unit
t <sub>FCL</sub>	SCL Fall Time	Standard Mode	20+0.1C <sub>B</sub>		300	ns
		Fast Mode	20+0.1C <sub>B</sub>		300	
		Fast Mode Plus	20+0.1C <sub>B</sub>		120	
		High-Speed Mode, C <sub>B</sub> ≤ 100 pF		10	40	
		High-Speed Mode, C <sub>B</sub> ≤ 400 pF		20	80	
t <sub>RCL1</sub>	Rise Time of SCL after a Repeated START Condition and after ACK Bit	High-Speed Mode, C <sub>B</sub> ≤ 100 pF		10	80	ns
		High-Speed Mode, C <sub>B</sub> ≤ 400 pF		20	160	
t <sub>RDA</sub>	SDA Rise Time	Standard Mode	20+0.1C <sub>B</sub>		1000	ns
		Fast Mode	20+0.1C <sub>B</sub>		300	
		Fast Mode Plus	20+0.1C <sub>B</sub>		120	
		High-Speed Mode, C <sub>B</sub> ≤ 100 pF		10	80	
		High-Speed Mode, C <sub>B</sub> ≤ 400 pF		20	160	
t <sub>FDA</sub>	SDA Fall Time	Standard Mode	20+0.1C <sub>B</sub>		300	ns
		Fast Mode	20+0.1C <sub>B</sub>		300	
		Fast Mode Plus	20+0.1C <sub>B</sub>		120	
		High-Speed Mode, C <sub>B</sub> ≤ 100 pF		10	80	
		High-Speed Mode, C <sub>B</sub> ≤ 400 pF		20	160	
t <sub>SU;STO</sub>	Stop Condition Setup Time	Standard Mode		4		μs
		Fast Mode		600		ns
		Fast Mode Plus		120		ns
		High-Speed Mode		160		ns
C <sub>B</sub>	Capacitive Load for SDA and SCL				400	pF

## Timing Diagrams

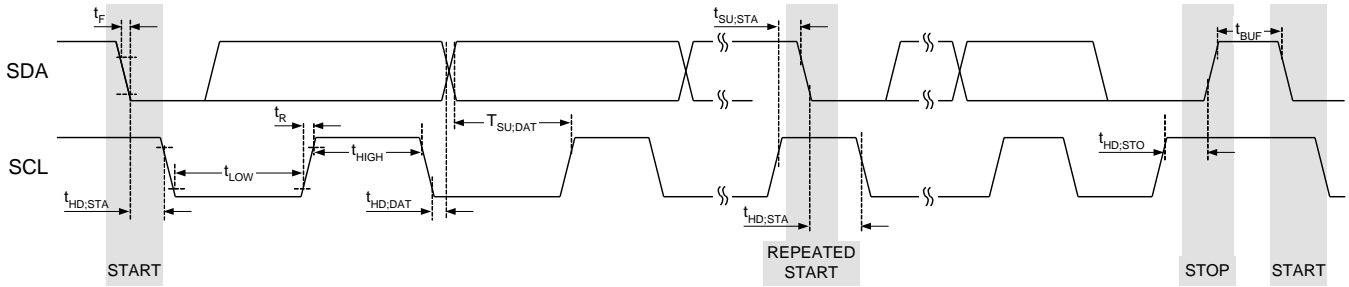

**Figure 5. I<sup>2</sup>C Interface Timing for Fast and Slow Modes**

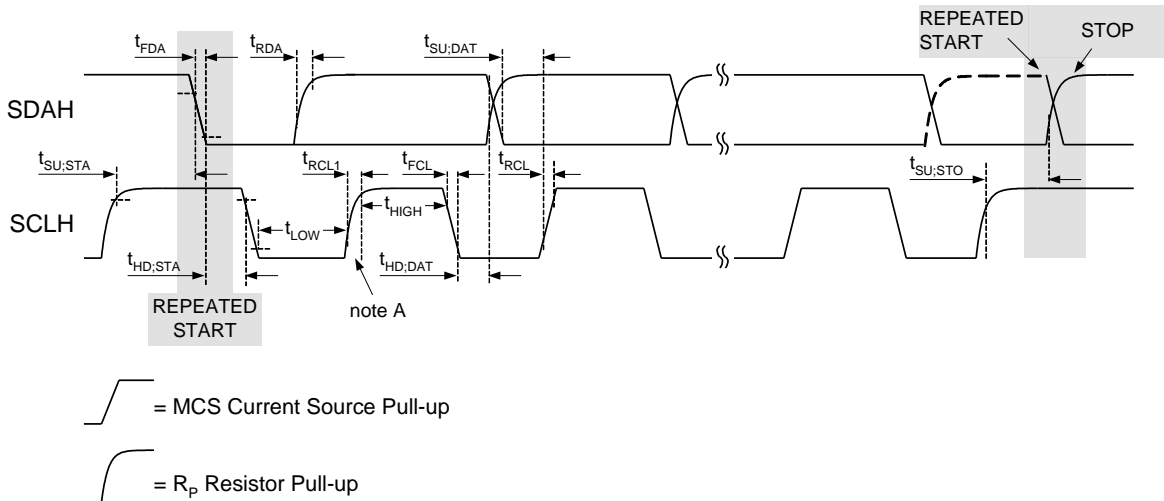

Note A: First rising edge of SCLH after Repeated Start and after each ACK bit.

**Figure 6. I<sup>2</sup>C Interface Timing for High-Speed Mode**

## Charge Mode Typical Characteristics

Unless otherwise specified, circuit of Figure 1,  $V_{OREG}=4.35\text{ V}$ ,  $I_{OCHARGE}=950\text{ mA}$ ,  $V_{BUS}=5.0\text{ V}$ , and  $T_A=25^\circ\text{C}$ .

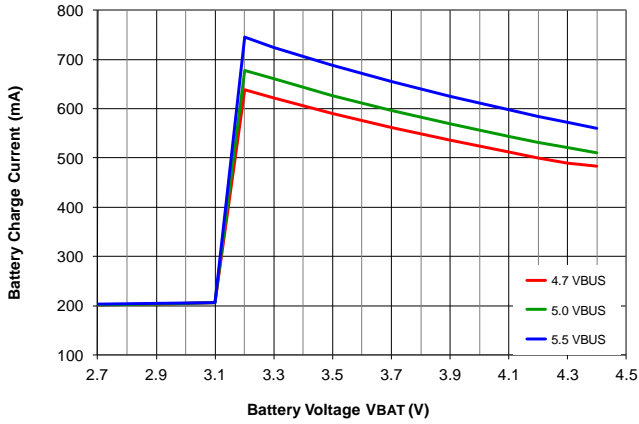

**Figure 7. Battery Charge Current vs.  $V_{BUS}$  with  $I_{BUSLIM}=500\text{ mA}$**

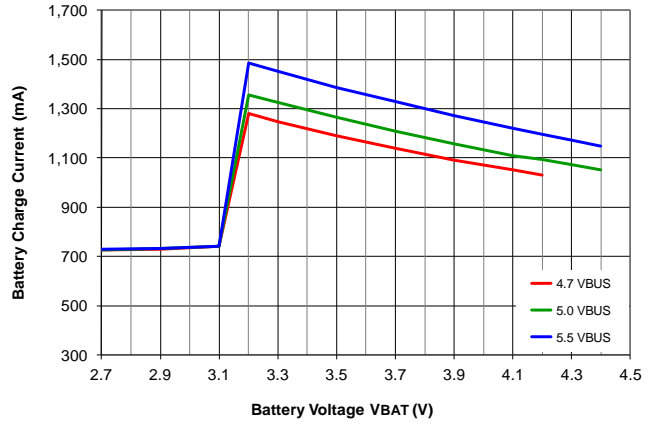

**Figure 8. Battery Charge Current vs.  $V_{BUS}$  with  $I_{BUSLIM}=1100\text{ mA}$**

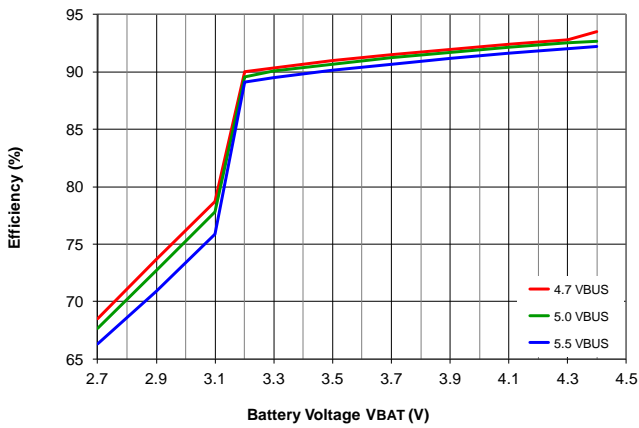

**Figure 9. Efficiency vs.  $V_{BUS}$ ,  $I_{BUSLIM}=500\text{ mA}$ ,  $I_{SYS}=0$**

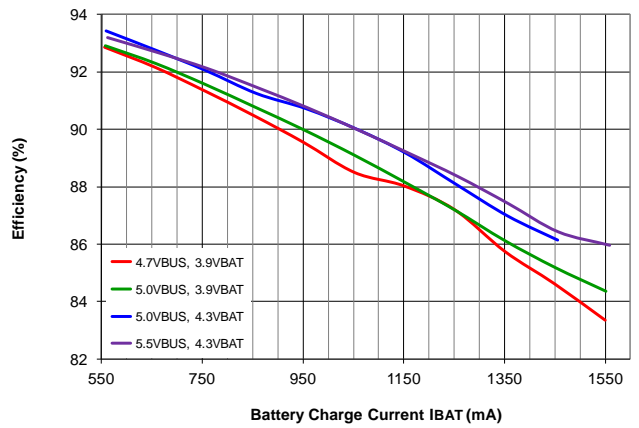

**Figure 10. Efficiency vs. Charging Current,  $I_{BUSLIM}=\text{No Limit}$**

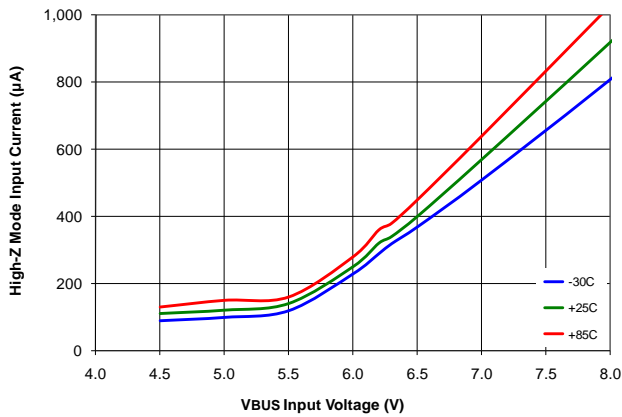

**Figure 11. HZ Mode  $V_{BUS}$  Current vs. Temperature,  $3.7\text{ V}_{BAT}$**

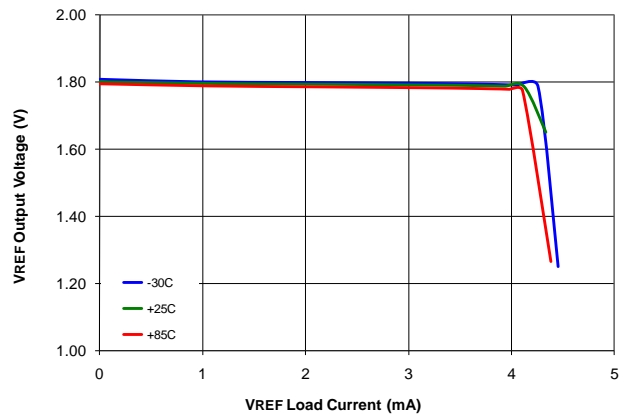

**Figure 12.  $V_{REF}$  vs. Load Current, Over-Temperature**

## Charge Mode Typical Characteristics

Unless otherwise specified, circuit of Figure 1,  $V_{OREG}=4.35\text{ V}$ ,  $I_{OCHARGE}=950\text{ mA}$ ,  $V_{BUS}=5.0\text{ V}$ , and  $T_A=25^\circ\text{C}$ .

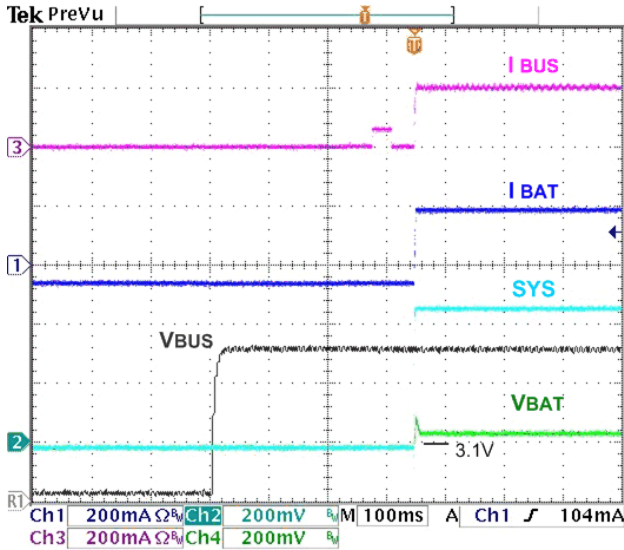

**Figure 13. Charger Startup at  $V_{BUS}$  Plug-In, 500 mA  $I_{BUSLIM}$ , 3.1  $V_{BAT}$ , 50  $\Omega$  SYS Load, CE# = 0, IO\_LVL=1**

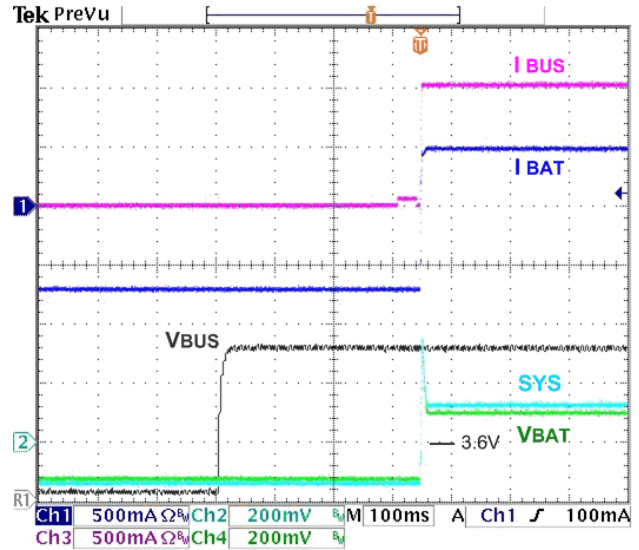

**Figure 14. Charger Startup at  $V_{BUS}$  Plug-In, 1100 mA  $I_{BUSLIM}$ , 3.6  $V_{BAT}$ , 700 mA SYS Load, CE# = 0, IO\_LVL=0**

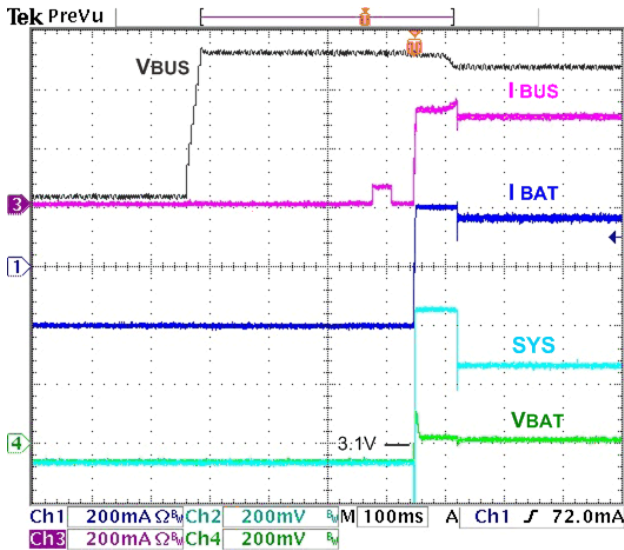

**Figure 15. Charger Startup at  $V_{BUS}$  Plug-In Using 300 mA Current Limited Source, 500 mA  $I_{BUSLIM}$ , 3.1  $V_{BAT}$ , 200 mA SYS Load, CE# = 0, IO\_LVL=0**

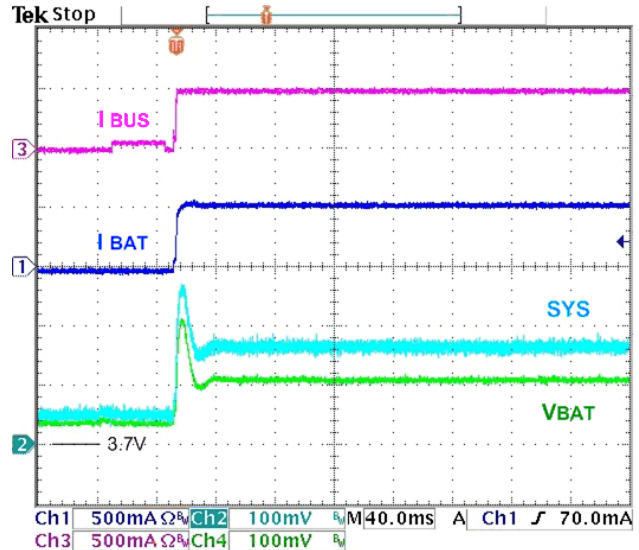

**Figure 16. Charger Startup with HZ Bit Reset, 500 mA  $I_{BUSLIM}$ , 950 mA  $I_{CHARGE}$ , 50  $\Omega$  SYS Load, CE# = 0**

## Charge Mode Typical Characteristics

Unless otherwise specified, circuit of Figure 1,  $V_{OREG}=4.35\text{ V}$ ,  $I_{OCHARGE}=950\text{ mA}$ ,  $V_{BUS}=5.0\text{ V}$ , and  $T_A=25^\circ\text{C}$ .

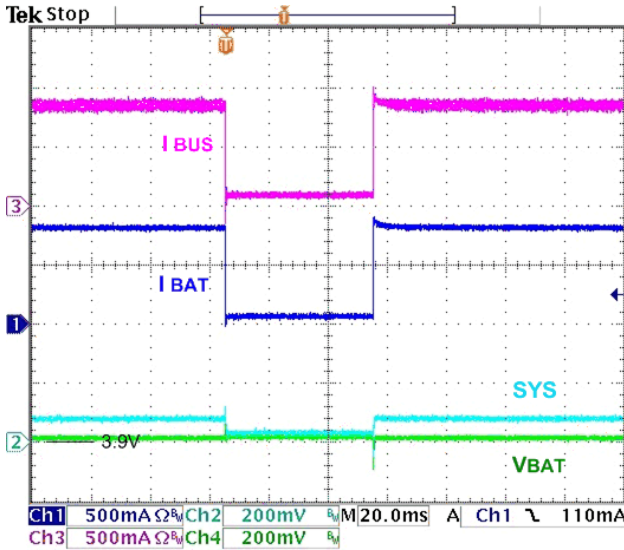

Figure 17. Battery Removal / Insertion while Charging,  $TE=0$ ,  $3.9\text{ V}_{BAT}$ ,  $I_{CHRG}=950\text{ mA}$ ,  $I_{BUSLIM}=\text{No Limit}$ ,  $50\ \Omega\text{ SYS Load}$

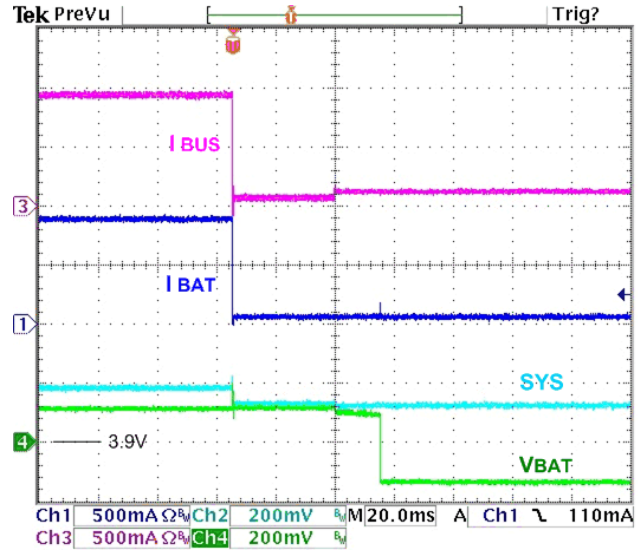

Figure 18. Battery Removal / Insertion when Charging,  $TE=1$ ,  $3.9\text{ V}_{BAT}$ ,  $I_{BUSLIM}=\text{No Limit}$ ,  $50\ \Omega\text{ SYS Load}$

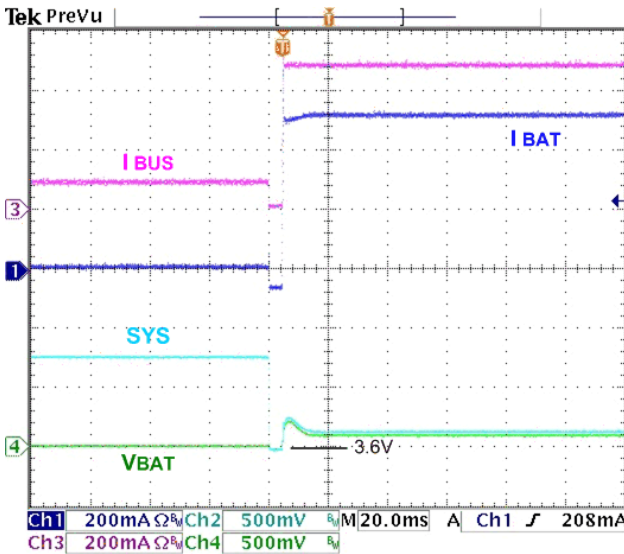

Figure 19. Charger Enable ( $CE\# = 1-0$ ) with  $V_{BUS}$  Applied,  $I_{BUSLIM}=500\text{ mA}$ ,  $200\text{ mA SYS Load}$ ,  $IO\_LVL=0$

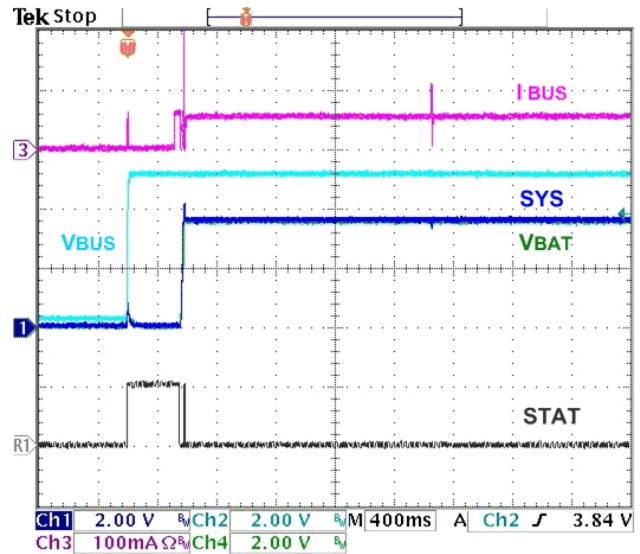
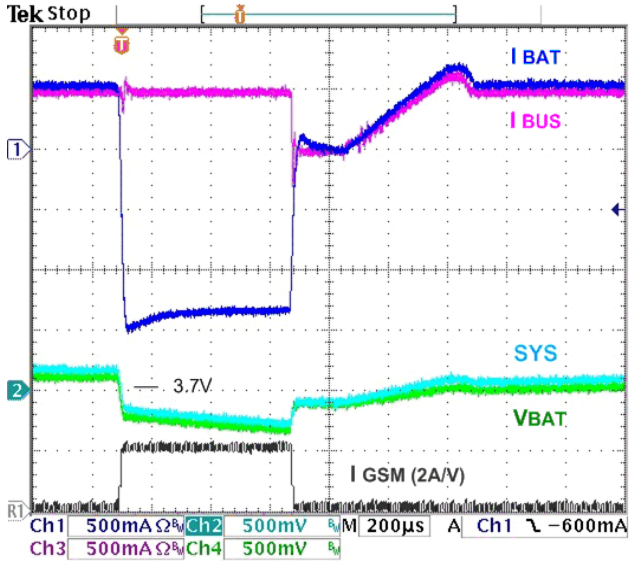

Figure 20. No Battery at  $V_{BUS}$  Power-Up,  $100\ \Omega\text{ SYS Load}$ ,  $1\text{ k}\Omega\text{ V}_{BAT}\text{ Load}$

## GSM Typical Characteristics

A 2.0 A GSM pulse applied at  $V_{BAT}$  with 5  $\mu$ s rise / fall time. Simultaneous to GSM pulse, 50  $\Omega$  additional load applied at SYS.



**Figure 21. 2.0 A GSM Pulse Response,**  
 $I_{BUSLIM}=500$  mA Control,  $I_{CHRG}=950$  mA, 3.7 V<sub>BAT</sub>,  
 OREG=4.35 V

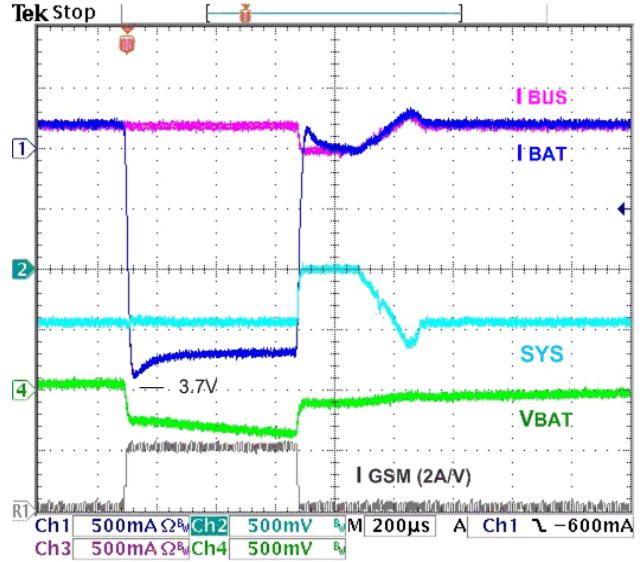

**Figure 22. 2.0 A GSM Pulse Response,**  
 $I_{BUSLIM}=500$  mA,  $I_{CHRG}=950$  mA, 3.7 V<sub>BAT</sub>,  
 OREG=4.35 V, 200 mA Source Current Limit

## Boost Mode Typical Characteristics

Unless otherwise specified, using circuit of Figure 1,  $V_{BAT}=3.6\text{ V}$ ,  $T_A=25^\circ\text{C}$ .

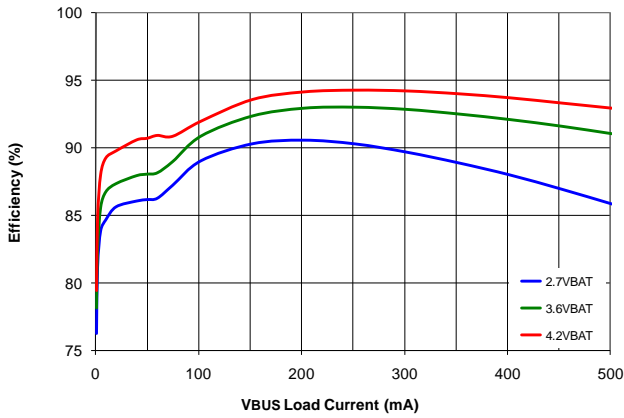

**Figure 23. Efficiency vs.  $I_{BUS}$  Over  $V_{BAT}$**

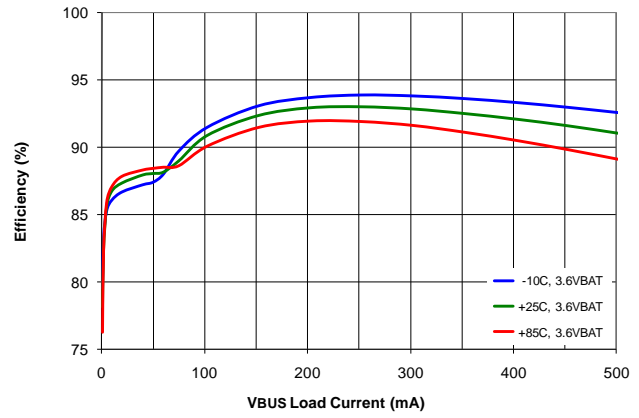

**Figure 24. Efficiency vs.  $I_{BUS}$  Over-Temperature,  $3.6\text{ V}_{BAT}$**

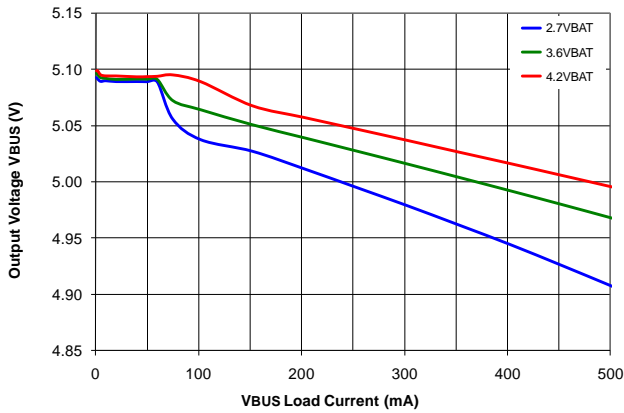

**Figure 25. Regulation vs.  $I_{BUS}$  Over  $V_{BAT}$**

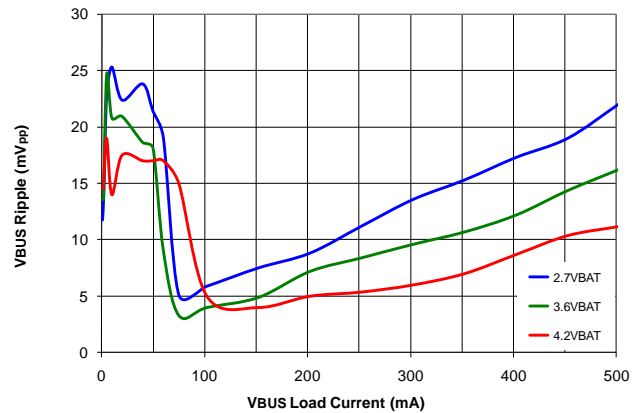

**Figure 26. Output Ripple vs.  $I_{BUS}$  Over  $V_{BAT}$**

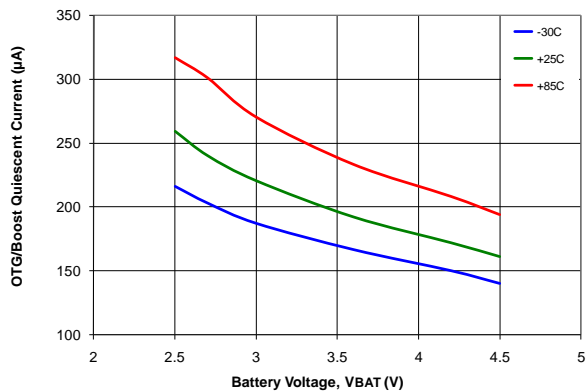

**Figure 27. Quiescent Current ( $I_Q$ ) vs.  $V_{BAT}$  Over-Temperature**

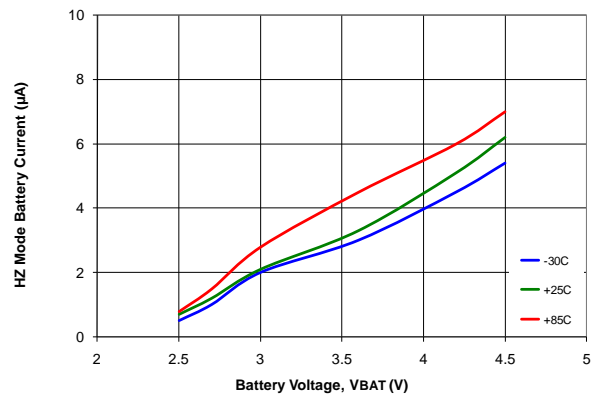

**Figure 28. Battery Discharge Current vs.  $V_{BAT}$ , HZ / Sleep Mode**



## Boost Mode Typical Characteristics

Unless otherwise specified, using circuit of Figure 1,  $V_{BAT}=3.6\text{ V}$ ,  $T_A=25^\circ\text{C}$ .

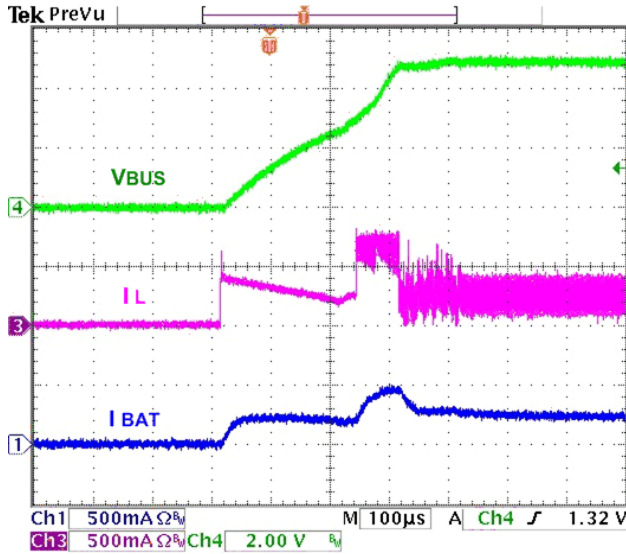

Figure 29. OTG Startup, 50  $\Omega$  Load, 3.6  $V_{BAT}$   
External / Additional 10  $\mu\text{F}$  on  $V_{BUS}$

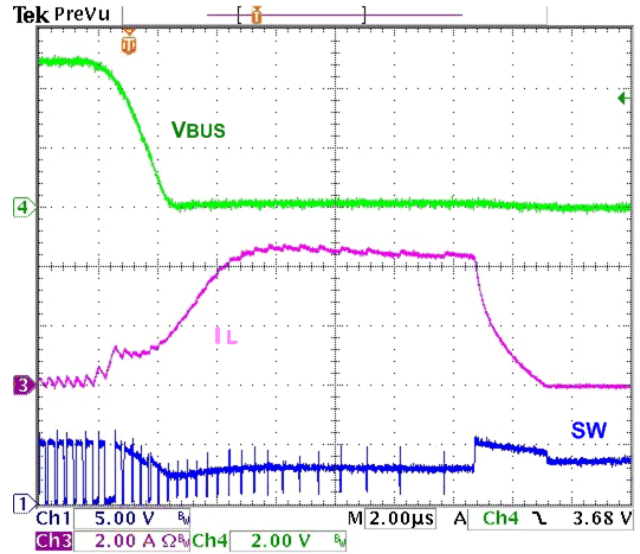

Figure 30. OTG  $V_{BUS}$  Overload Response

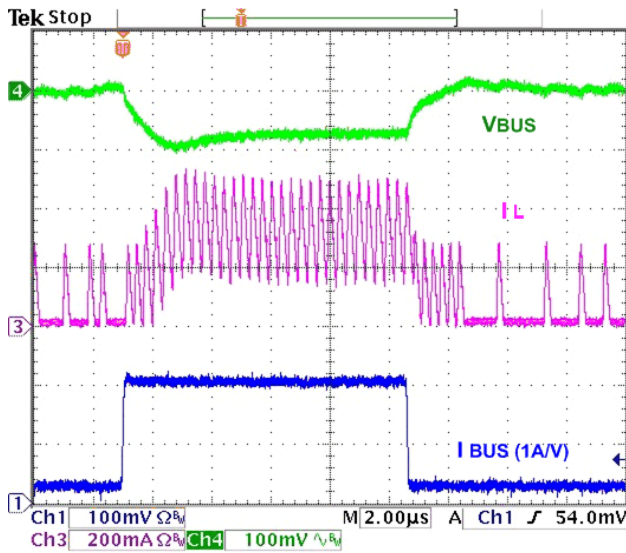

Figure 31. Load Transient, 20-200-20 mA  $I_{BUS}$ ,  
 $t_{RISE/FALL}=100\text{ ns}$

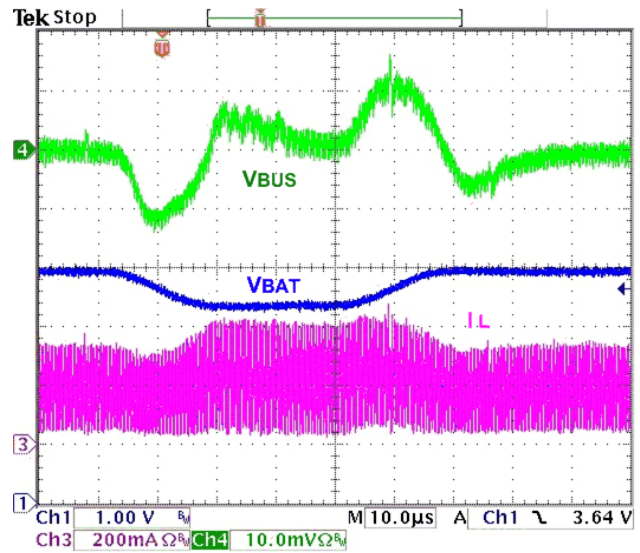

Figure 32. Line Transient, 50  $\Omega$  Load, 3.9-3.3-  
3.9  $V_{BAT}$ ,  $t_{RISE/FALL}=10\text{ }\mu\text{s}$

## Circuit Description / Overview

When charging batteries with a current-limited input source, such as USB, a switching charger's high efficiency over a wide range of output voltages minimizes charging time.

FAN54053 combines a highly integrated synchronous buck regulator for charging with a synchronous boost regulator, which can supply 5 V to USB On-The-Go (OTG) peripherals. The FAN54053 employs synchronous rectification for both the charger and boost regulators to maintain high efficiency over a wide range of battery voltages and charge states.

The FAN54053 has four operating modes:

1. **Charge Mode:**  
Charges a single-cell Li-ion or Li-polymer battery.
2. **Boost Mode:**  
Provides 5 V power to USB-OTG with an integrated synchronous rectification boost regulator, using the battery as input.
3. **High-Impedance Mode:**  
Both the boost and charging circuits are OFF in this mode. Current flow from VBUS to the battery or from the battery to VBUS is blocked in this mode. This mode consumes very little current from VBUS or the battery.
4. **Production Test Mode:**  
This mode provides 4.35 V output on VBAT and supplies a load current of up to 2.3 A.

## Charge Mode and Registers

### Charge Mode

In Charge Mode, FAN54053 employs six regulation loops:

1. **Input Current:** Limits the amount of current drawn from VBUS. This current is sensed internally and can be programmed through the I<sup>2</sup>C interface.
2. **Charging Current:** Limits the maximum charging current. This current is sensed using an internal sense MOSFET.
3. **VBUS Voltage:** This loop is designed to prevent the input supply from being dragged below V<sub>BUSLIM</sub> (typically 4.5 V) when the input power source is current limited. An example of this would be a travel charger. This loop cuts back the current when V<sub>BUS</sub> approaches V<sub>BUSLIM</sub>, allowing the input source to run in current limit.
4. **Charge Voltage:** The regulator is restricted from exceeding this voltage. As the internal battery voltage rises, the battery's internal impedance works in conjunction with the charge voltage regulation to decrease the amount of current flowing to the battery. Battery charging is completed when the current through Q4 drops below the I<sub>TERM</sub> threshold.
5. **Pre-charge:** When V<sub>BAT</sub> is below V<sub>BATMIN</sub>, Q4 operates as a linear current source and modulates its current to ensure that the voltage on SYS stays above 3.4 V.
6. **Temperature:** If the IC's junction temperature reaches 120°C, charge current is reduced until the IC's temperature is below 120°C.

### PWM Controller in Charge Mode

The IC uses a current-mode PWM controller to regulate the output voltage and battery charge currents. The synchronous rectifier (Q2) has a negative current limit that turns off Q2 at 140 mA to prevent current flow from the battery.

### Battery Charging Curve

If the battery voltage is below V<sub>SHORT</sub>, a linear current source pre-charges the battery until V<sub>BAT</sub> reaches V<sub>SHORT</sub>. The PWM charging circuit is then started and the battery is charged with a constant current if sufficient input power is available. The current slew rate is limited to prevent overshoot.

During the current regulation phase of charging, I<sub>BUSLIM</sub> or the programmed charging current limits the amount of current available to charge the battery and power the system.

During the voltage regulation phase of charging, assuming that V<sub>OREG</sub> is programmed to the cell's fully charged "float" voltage, the current that the battery accepts with the PWM regulator limiting its output (sensed at VBAT) to V<sub>OREG</sub> declines.

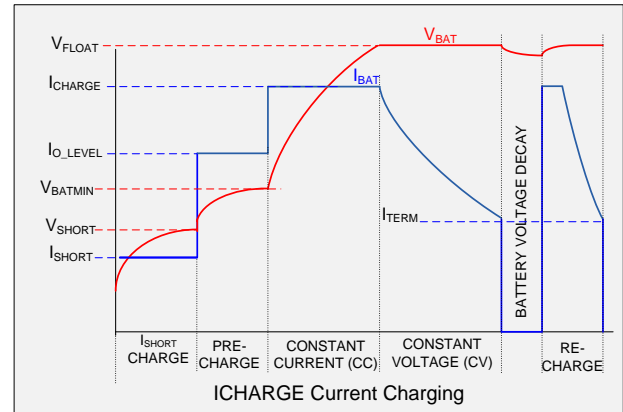

**Figure 33. Charge Curve, I<sub>CHARGE</sub> Not Limited by I<sub>BUSLIM</sub>**

The FAN54053 is designed to work with a current-limited input source at VBUS as shown below:

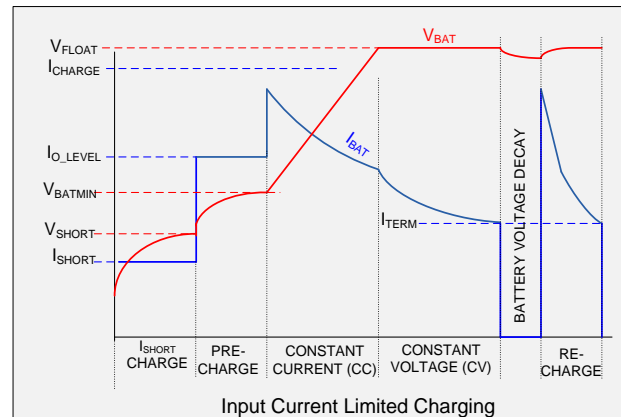

**Figure 34. Charge Curve, I<sub>BUSLIM</sub> Limits I<sub>CHARGE</sub>**

The following charging parameters can be programmed by the host through I<sup>2</sup>C:

**Table 3. Programmable Charging Parameters**

Parameter	Name	Register
Output Voltage Regulation	V <sub>OREG</sub>	REG2[7:2]
Battery Charging Current Limit	I <sub>CHARGE</sub>	REG4[6:3]
Input Current Limit	I <sub>BUSLIM</sub>	REG1[7:6]
Charge Termination Limit	I <sub>TERM</sub>	REG4[2:0]
Weak Battery Voltage	V <sub>LOWV</sub>	REG1[5:4]
VBUS Control	V <sub>BUSLIM</sub>	REG5[2:0]

### Output Voltage Regulation (V<sub>OREG</sub>)

The charger output or “float” voltage can be programmed by the OREG (REG02[7:2]) bits from 3.51 V to 4.45 V in 20 mV increments. The default setting is 3.55 V.

See OREG Register Bit Definitions

### Battery Charging Current Limit (I<sub>CHARGE</sub>)

When the IO\_LEVEL bit is set (default), the I<sub>CHARGE</sub> bits are ignored and charge current is set to 200 mA.

See IOCHARGE Register Bit Definitions

### Input Current Limiting (I<sub>BUSLIM</sub>)

To minimize charging time without overloading VBUS current limitations, the IC’s input current limit can be programmed by the I<sub>BUSLIM</sub> (REG1[7:6]) bits.

For the FAN54053, no charging occurs automatically at V<sub>BUS</sub> POR, so the input current limit is established by the I<sub>BUSLIM</sub> bits.

See IBUSLIM Register Bit Definitions

### Termination Limit (I<sub>TERM</sub>)

Charge current termination can be enabled or disabled using the TE (REG01h[3]) bit. By default TE = “0”, therefore, termination is disabled and charging does not terminate at the programmed I<sub>TERM</sub> level.

When TE = “1”, and V<sub>BAT</sub> reaches V<sub>OREG</sub>, the charging current is reduced, limited by the battery’s ESR and its internal cell voltage. When the charge current falls below I<sub>TERM</sub>, PWM charging stops, but the STAT pin remains LOW. The STAT pin then goes HIGH and the STAT bits change to CHARGE DONE (10), provided the battery and charger are still connected. If V<sub>BAT</sub> falls to V<sub>RCH</sub> below V<sub>OREG</sub>, the Fast Charge cycle starts again.

Post-charging can be enabled to “top-off” the battery to a lower termination current threshold than I<sub>TERM</sub>. The PC\_EN bit (REG07h[3]) must be set to “1” before the battery charging current reaches I<sub>TERM</sub>. The lower termination current is set by the PC\_IT (REG07h[2:0]) bits. Post-charging begins after normal charging is ended (as described above) with the PC\_ON (REG11h[2]) monitor bit set to “1”.

During post-charging, the STAT pin is HIGH, indicating that the charge current is below the I<sub>TERM</sub> level. Once the current reaches the threshold for post-charging completion (PC\_IT),

PWM charging stops and the PC\_ON bit changes back to “0”. If the charging current goes above I<sub>TERM</sub> without first falling to PC\_IT, the PC\_ON bit can be reset by using any of these methods: V<sub>BAT</sub> moving below and above V<sub>BATMIN</sub>, a V<sub>BUS</sub> POR, or the CE# or HZ\_MODE bit cycled. If V<sub>BAT</sub> falls to V<sub>RCH</sub> below V<sub>OREG</sub>, the Fast Charge cycle starts again.

See ITERM Register Bit Definitions

### Weak Battery Voltage (V<sub>LOWV</sub>)

The FAN54053 monitors the level of the battery with respect to a programmable V<sub>LOWV</sub> (REG01h<5:4>) threshold (default 3.7 V). The V<sub>LOWV</sub> threshold defines the voltage level of the battery at which the system is guaranteed to be fully operational when only powered by the battery.

The POK\_B pin pulls LOW once V<sub>BAT</sub> reaches V<sub>LOWV</sub>, and remains LOW as long as the IC is in Fast Charge. The IC will remain in Fast Charge as long as V<sub>BAT</sub> > 3.0 V.

See VLOWV Register Bit Definitions

### VBUS Control loop (V<sub>BUSLIM</sub>)

The IC includes a control loop that limits input current in case a current-limited source is supplying V<sub>BUS</sub>.

The control increases the charging current until either:

- I<sub>BUSLIM</sub> or I<sub>CHARGE</sub> is reached OR
- V<sub>BUS</sub> = V<sub>BUSLIM</sub>.

If V<sub>BUS</sub> collapses to V<sub>BUSLIM</sub>, the VBUS loop reduces its current to keep V<sub>BUS</sub> = V<sub>BUSLIM</sub>. When the VBUS control loop is limiting the charge current, the VLIM bit (REG05h[3]) is set.

See VBUSLIM Register Bit Definitions

## Charger Operation

### Safety Timer

By default the safety timers do not run in the FAN54053. The safety timers can be enabled by setting the WD\_DIS register bit, (REG13h[1]) to “0”. When WD\_DIS = “0”, charging is controlled by the host with the t<sub>32S</sub> timer running to ensure that the host is alive.

All following information in this section assumes the timer has been enabled.

At VBUS plug in, the TMR\_RST bit must be set within 2 seconds of VBUS rising above V<sub>(INMIN)1</sub> or all registers except for SAFETY (REG06h), are set to their default values. This functionality occurs regardless of the state of the CE# and WD\_DIS bit. If plug in occurs with the device in a HZ or Charge Done state, the register resets will occur when the device enters PWM Charging or Recharge. If the TMR\_RST (REG00h[7]) bit is set within 2 seconds of VBUS rising above V<sub>(INMIN)1</sub>, the t<sub>32S</sub> is started, and the device enters PWM Charging. Setting the TMR\_RST bit resets the t<sub>32S</sub> timer. If the t<sub>32S</sub> timer times out; all registers (except SAFETY) are set to their default values (including WD\_DIS and CE#), the FAULT bits are set to “110”, and STAT is pulsed. The t<sub>32S</sub> timer can be armed by writing to any bit in the register map except for RESET.

## V<sub>BUS</sub> POR / Non-Compliant Charger Rejection

256 ms after V<sub>BUS</sub> is connected, the IC pulses the STAT pin and sets the V<sub>BUS</sub>\_CON bit. Before starting to supply current, the IC applies a 110 Ω load from V<sub>BUS</sub> to GND. V<sub>BUS</sub> must remain above V<sub>IN(MIN)</sub>1 and below V<sub>BUS\_OVP</sub> for t<sub>VBUS\_VALID</sub> (32 ms) before the IC initiates charging or supplies power to SYS.

The V<sub>BUS</sub> validation sequence always occurs before significant current is available to be drawn from V<sub>BUS</sub> (for example, after a V<sub>BUS</sub> OVP fault or a V<sub>RCH</sub> (recharge initiation). t<sub>VBUS\_VALID</sub> ensures that unfiltered 50/60 Hz chargers and other non-compliant chargers are rejected.

## USB-Friendly Boot Sequence

The FAN54053 does not automatically initiate charging at V<sub>BUS</sub>POR. Instead, prior to receiving host commands, the buck is enabled to provide power to SYS while Q4 and Q5 remain off until register bit CE# (REG01[2]) is set to “0” through the I<sup>2</sup>C interface, allowing charging through Q4.

## Startup with No Battery

The FAN54053 has Battery Absent Behavior enabled. At V<sub>BUS</sub> POR with the battery absent, the PWM will run, providing 3.55 V to the system from the input source with current limited by the default I<sub>BUSLIM</sub> setting.

## Startup with a Dead Battery

At V<sub>BUS</sub> POR, if V<sub>BAT</sub> < V<sub>SHORT</sub>, all registers, including the SAFETY register, are reset to their default values and the DBAT\_B (REG02h[1]) bit is reset. CE# = “1”, so charging is disabled.

If the battery’s protection switch is open, the PWM will run, providing 3.55 V to the system from the input source with current limited by the default I<sub>BUSLIM</sub> setting. This allows the host processor to awaken and establish host control. Once this occurs, the host’s low level software can program the CE# bit to “0” and a linear current source closes the battery protection switch. When V<sub>BAT</sub> voltage rises above V<sub>SHORT</sub> and sufficient power is available, PWM charging begins and the battery is charged through the BATFET, Q4. The IO\_LEVEL (REG05h[5]) bit is set to “1” by default which limits charge current to 200 mA.

With CE# = “1” once V<sub>BAT</sub> rises above V<sub>SHORT</sub>, DBAT\_B is set. With CE# = “0” once V<sub>BAT</sub> rises above V<sub>BATMIN</sub>, DBAT\_B is set.

## Power Path Operation

As long as V<sub>BAT</sub> < V<sub>BATMIN</sub>, Q4 operates as a linear current source, (Precharge) with its current (I<sub>PP</sub>) limited to 200 mA when IO\_LEVEL (REG05h[5]) is set to its default value of “1”. If IO\_LEVEL is set to “0” and I<sub>LIM</sub> > “01”, charge current is limited to 450 mA when I<sub>CHARGE</sub> ≤ 750 mA, and 730 mA when I<sub>CHARGE</sub> > 750 mA. Providing the input current is not limited by the I<sub>BUSLIM</sub> setting or the current available from the source, during precharge, the IC regulates SYS to 3.55 V and provides the IO\_LEVEL limited current to the battery.

System power always has the highest priority when power from the buck is limited ensuring SYS does not fall below 3.4 V. This is managed by folding back the current to charge the battery until charge current is reduced to 0 A.

After V<sub>BAT</sub> reaches V<sub>BATMIN</sub>, Q4 closes and is used as a current-sense element to limit current (I<sub>CHRG</sub>) per the I<sup>2</sup>C register settings. This is accomplished by limiting the PWM modulator’s current (Fast Charge). If SYS drops more than 5 mV (V<sub>THSYS</sub>) below V<sub>BAT</sub> and CE# = “0”, Q4 and Q5 are turned on (GATE is pulled LOW). If CE# = “1”, only Q5 is turned on. Once SYS voltage becomes higher than V<sub>BAT</sub>, Q5 is turned off and Q4 again serves as the current-sense element to limit I<sub>CHRG</sub>.

If CE# = “1” and DIS pin is high or CE# = “1” and HZ\_MODE = “1” while V<sub>BAT</sub> > V<sub>LOWV</sub>, so as to prevent the system from crashing, Q4 and Q5 are enabled. Q4 and Q5 are also both turned on when the IC enters SLEEP Mode (V<sub>BUS</sub> < V<sub>BAT</sub>).

## POK\_B (see Table 4)

The POK\_B pin and POK\_B (REG11h[5]) bit are intended to provide feedback to the baseband processor that the battery is strong enough to allow the device to fully function. Whenever the IC is operating in precharge, POK\_B is HIGH. On exiting Precharge, POK\_B remains HIGH until V<sub>BAT</sub> > V<sub>LOWV</sub>. REG01h[5:4] sets the V<sub>LOWV</sub> threshold. POK\_B pulls LOW once V<sub>BAT</sub> reaches V<sub>LOWV</sub>, and remains LOW as long as the IC is in Fast Charge and the IC will remain in Fast Charge as long as V<sub>BAT</sub> > 3.0 V. If the battery voltage falls below 3.0 V the IC enters Precharge. If WD\_DIS = “0” and the T<sub>32S</sub> expires during charging, the POK\_B pin will go high.

If the battery was above V<sub>LOWV</sub> and has fallen below the level, the POK\_B bit can be set to change the state of the pin to be high. This setting of the bit and pin can be used to signal the system into a low-power state, preventing excessive loading from the system while attempting to recharge a depleted battery.

The STAT pin pulses any time the POK\_B pin changes.

**Table 4. Q4, Q5, POK\_B vs. Operating Mode**

Operating Mode	V <sub>BUS</sub>	V <sub>BAT</sub>	CE#	PWM	V <sub>SYS</sub>	Q4	Q5	GATE	POK_B
<b>BUS Disconnected</b>									
OFF	< V <sub>BAT</sub> OR < V <sub>IN(MIN)2</sub>	> V <sub>SHORT</sub>	X	OFF	≤ V <sub>BAT</sub>	ON	ON	LOW	HIGH
<b>VBUS Plug in with Battery Protection Switch Open</b>									
PWM	Valid	OPEN	1	ON	V <sub>OREG</sub>	OFF	OFF	HIGH	HIGH
			0						Indeterminate <sup>(8)</sup>
30 mA Linear Charging <sup>(9)</sup>	Valid	< V <sub>SHORT</sub>	0	ON	3.55	OFF	OFF	HIGH	HIGH
<b>Charge Mode</b>									
Precharge	Valid	> V <sub>SHORT</sub> and < V <sub>BATMIN</sub>	0	ON	3.55	Linear	OFF	HIGH	HIGH
Precharge: I <sub>SYS</sub> + I <sub>pp</sub> > I <sub>PWM</sub> , I <sub>BAT</sub> < I <sub>PP</sub>	Valid	< V <sub>BATMIN</sub>	0	ON	< 3.55	Linear	OFF	HIGH	HIGH
Fast Charge	Valid	> V <sub>BATMIN</sub> and < V <sub>LOWV</sub>	0	ON	> V <sub>BAT</sub>	ON	OFF	HIGH	HIGH
		> V <sub>LOWV</sub>							LOW
<b>Battery Voltage Falling from Fast Charge</b>									
Precharge	Valid	V <sub>BATFALL</sub>	0	ON	3.55	ON	OFF	HIGH	HIGH
<b>Battery Supplementing SYS</b>									
Supplemental Mode : I <sub>SYS</sub> > I <sub>PWM</sub>	Valid	> V <sub>SHORT</sub>	1	ON	< V <sub>BAT</sub>	X	ON	LOW	X
		> V <sub>BATMIN</sub> and > V <sub>SYS</sub> + V <sub>THSYS</sub>	0	ON	< V <sub>BAT</sub>	X	ON	LOW	X

**Note:**

- When V<sub>BAT</sub> is open it can float to V<sub>SYS</sub>, and POK\_B = HIGH when V<sub>BAT</sub> < V<sub>LOWV</sub> and POK\_B = LOW when V<sub>BAT</sub> > V<sub>LOWV</sub>.
- 30 mA Linear Charging operating mode assumes the host has programmed CE# = "0" during PWM Operating Mode.

**Charger Status / Fault Status**

The STAT pin indicates the operating condition of the IC and provides a fault indicator for interrupt driven systems.

**Table 5. STAT Pin Function**

EN_STAT	Charge State	STAT Pin
0	X	OPEN
X	Normal Conditions	OPEN
1	Charging	LOW
X	Fault (Charging or Boost)	128 μs Pulse, then OPEN

The FAULT bits (REG00h[2:0]) indicate the type of fault in Charge Mode.

**Monitor Registers (REG10h, REG11h)**

Additional status monitoring bits enable the host processor to have more visibility into the status of the IC. The monitor bits are real-time status indicators and are not internally debounced or otherwise time qualified.

The state of the MONITOR register bits listed in High-Impedance Mode is valid only when V<sub>BUS</sub> is valid.

**Charge Mode Control Bits**

The CE# (REG01h[2]) bit is set to "1" by default, therefore, charging is disabled.

Setting the RESET (REG04h[7]) bit clears all registers (except SAFETY). The CE# bit will only be cleared if RESET occurs with a valid V<sub>BUS</sub> and V<sub>BAT</sub> < V<sub>LOWV</sub>. If HZ\_MODE or the WD\_DIS bit was set when the RESET bit is set, this bit is also cleared. Refer to the Register Bit Definitions section for more details.

The HZ\_MODE (REG01h[1]) and DIS pin will put the device in High-Impedance Mode. If HZ\_MODE = "1" or DIS pin is HIGH, so as to prevent the system from crashing, Q4 and Q5 are enabled.

The functionality of the HZ\_MODE (REG01h[1]) bit and DIS pin has a dependence upon V<sub>BAT</sub> voltage level and the WD\_DIS (REG13h[1]) bit state. Refer to Table 5 for details.

**Table 6. DIS Pin, HZ\_MODE and WD\_DIS bits Operation**

Conditions	Functionality
WD_DIS = 1 and $V_{BAT} > V_{LOWV}$	Setting either the HZ_MODE bit through I <sup>2</sup> C or the DIS pin to HIGH will disable the charger and put the IC into High-Impedance Mode. Resetting the HZ_MODE bit or the DIS pin to LOW will allow charging to resume. While in High-Impedance mode, if $V_{BAT}$ drops below $V_{LOWV}$ , all registers (except SAFETY), including HZ_MODE and CE# are reset. Note that charge parameters will need to be reprogrammed in order to completely charge the battery.
WD_DIS = 1 and $V_{BAT} < V_{LOWV}$	Setting either the HZ_MODE bit through I <sup>2</sup> C or the DIS pin to HIGH will reset all registers (except SAFETY), including HZ_MODE and CE#.
WD_DIS = 0 and $V_{BAT} > V_{LOWV}$	Setting either the HZ_MODE bit through I <sup>2</sup> C or the DIS pin to HIGH will stop the $t_{32S}$ timer from advancing (does not reset it), disable the charger, and put the IC into High-Impedance Mode. Resetting the HZ_MODE bit or the DIS pin to LOW will allow charging to resume.
WD_DIS = 0 and $V_{BAT} < V_{LOWV}$	Setting either the HZ_MODE bit through I <sup>2</sup> C or the DIS pin to HIGH will disable the charger and put the IC into High-Impedance Mode. The $T_{32S}$ timer will continue to run. If the $T_{32S}$ timer is allowed to overflow, all registers (except SAFETY) are reset, including WD_DIS, HZ_MODE and CE#.

**Flow Charts**

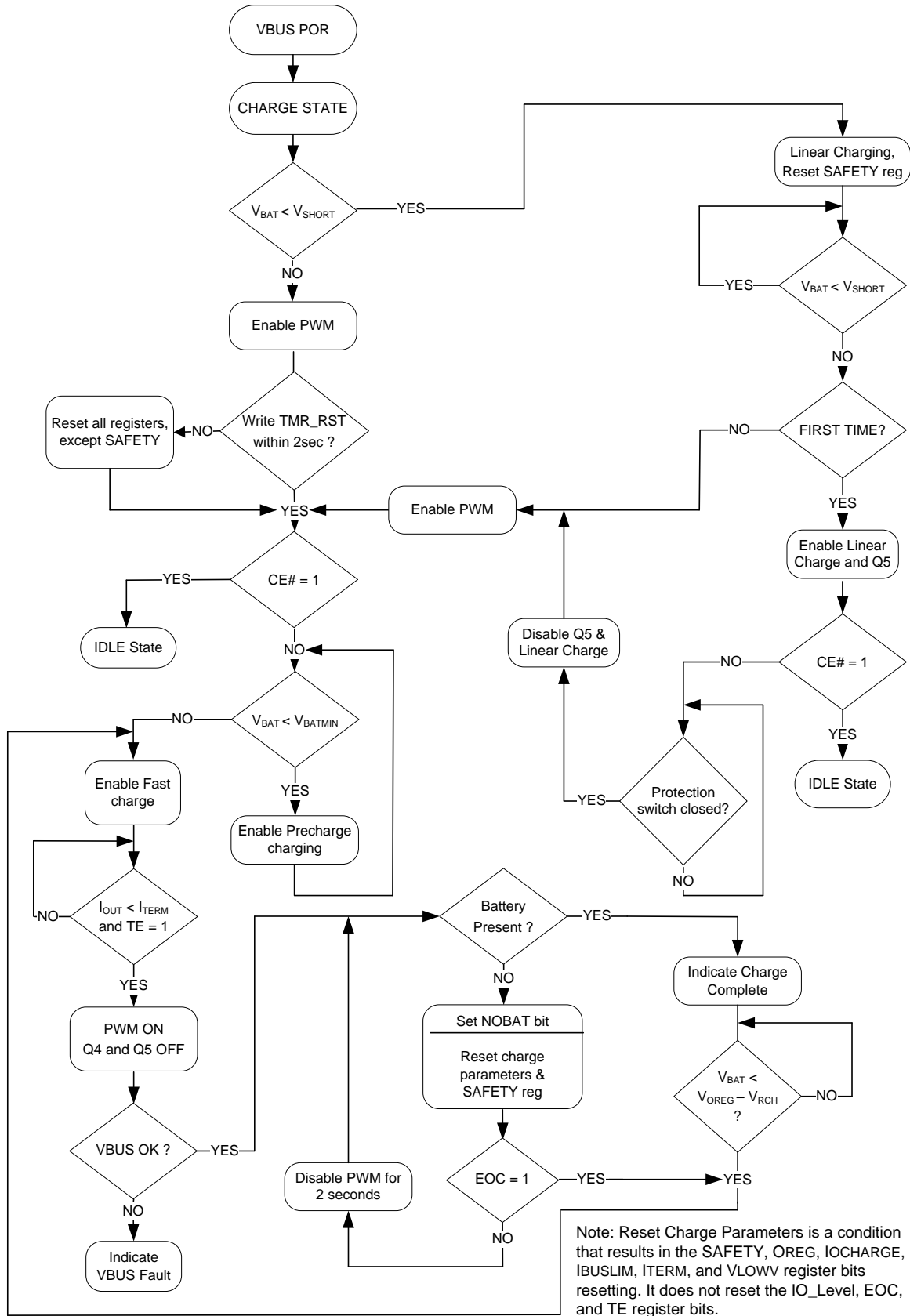

**Figure 35. Charge State Flow Chart**

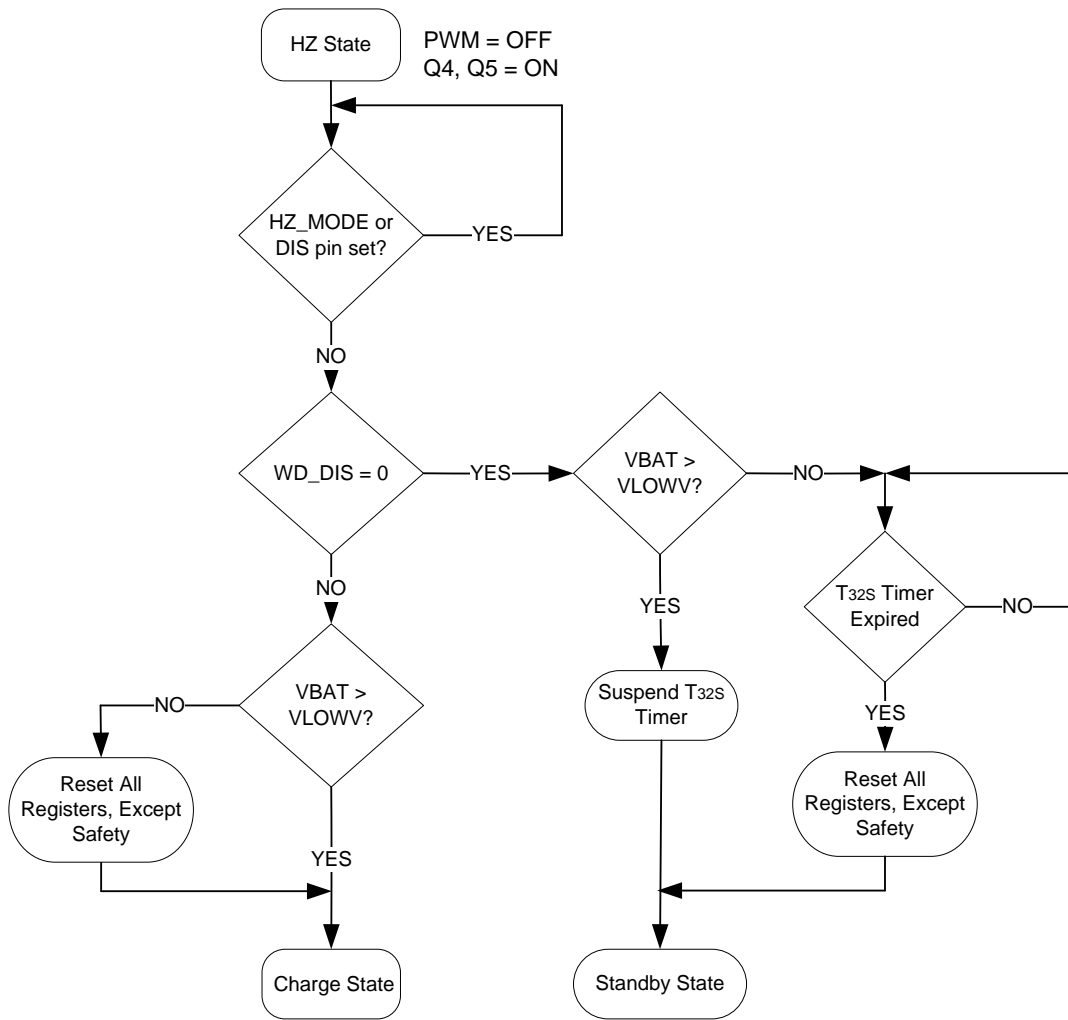

Figure 36. HZ State Flow Chart

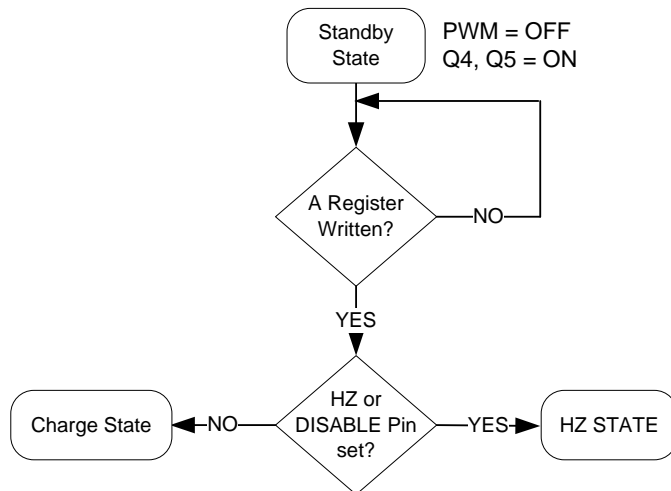

Figure 37. Standby State



## Non-Charging States

### Sleep Mode

When  $V_{BUS}$  falls below  $V_{BAT} + V_{SLP}$  and  $V_{BUS}$  is above  $V_{IN(MIN)2}$ , the IC enters Sleep Mode to prevent the battery from draining into  $V_{BUS}$ . During Sleep Mode, reverse current is disabled by body switching Q1.

### Idle State

The Idle State is related to the condition of the battery. During Idle mode the Switch Mode Power Supply (SMPS) is operating, but the battery is not being charged for one or more of the following conditions exists: the Safety Timer expires, charging is complete, or the BATFET is disabled by the Charge Enable bit,  $CE\# = "1"$ .

The PWM Buck continues to supply power to the system, but the Battery is no longer being charged and the BATFET is disabled.

### Standby State

The Standby State is an intermediate state where the switch mode supply is off due to either bad input power, the device has been put in High-Impedance Mode, or the die temperature is too hot.

## Charger Protection

### Battery Temperature (NTC) Monitor

The FAN54053 reduces the maximum charge current and termination voltage if an NTC measuring battery temperature ( $T_{BAT}$ ) indicates that it is outside the fast-charging limits (T2 to T3), as described in the JEITA specification<sup>1</sup>. There are four temperature thresholds that change battery charger operation: T1, T2, T3, and T4, shown in Table 7.

**Table 7. Battery Temperature Thresholds**

For use with 10 k $\Omega$  NTC,  $\beta = 3380$ , and  $R_{REF} = 10$  k $\Omega$ .

Threshold	Temperature	% of $V_{REF}$
T1	0°C	73.9
T2	10°C	64.6
T3	45°C	32.9
T4	60°C	23.3

**Table 8. Charge Parameters vs.  $T_{BAT}$**

$T_{BAT}$ (°C)	$I_{CHARGE}$	$V_{FLOAT}$
Below T1	Charging to $V_{BAT}$ Disabled	
Between T1 and T2	$I_{CHARGE} / 2^{(10)}$	4.0 V
Between T2 and T3	$I_{CHARGE}$	$V_{OREG}$
Between T3 and T4	$I_{CHARGE} / 2^{(10)}$	4.0 V
Above T4	Charging to $V_{BAT}$ Disabled	

#### Note:

10. If  $I_{CHARGE}$  is programmed to less than 650 mA, the charge current is limited to 340 mA.

<sup>1</sup> Japan Electronics and Information Technology Industries Association (JEITA) and Battery Association of Japan. "A Guide to the Safe Use of Secondary Lithium Ion Batteries in Notebook-type Personal Computers," April 28, 2007.

Thermistors with other  $\beta$  values can be used, with some shift in the corresponding temperature threshold, as shown in Table 9.

**Table 9. Thermistor Temperature Thresholds**

$R_{REF} = R_{THRM}$  at 25°C.

Parameter	Various Thermistors			
$R_{THRM(25^\circ C)}$	10 k $\Omega$	10 k $\Omega$	47 k $\Omega$	100 k $\Omega$
$\beta$	3380	3940	4050	4250
T1	0°C	3°C	6	8
T2	10°C	12°C	13	14
T3	45°C	42°C	41	40
T4	60°C	55°C	53	51

The host processor can disable temperature-driven control of charging parameters by writing "1" to the TEMP\_DIS bit. Since TEMP\_DIS is reset whenever the IC resets its registers, the temperature controls are enforced whenever the IC is auto-charging, since auto-charge is always preceded by a reset of registers.

To disable the thermistor circuit, tie the NTC pin to GND. Before enabling the charger, the IC tests to see if NTC is shorted to GND. If NTC is shorted to GND, no thermistor readings occur and the NTC\_OK and NTC1-NTC4 is reset.

The IC first measures the NTC immediately prior to entering any PWM charging state, then measures the NTC once per second, updating the result in NTC1-NTC4 bits (REG 12h[3:0]).

**Table 10. NTC1-NTC4 Decoding**

$T_{BAT}$ (°C)	NTC4	NTC3	NTC2	NTC1
Above T4	1	1	1	1
Between T3 and T4	0	1	1	1
Between T2 and T3	0	0	1	1
Between T1 and T2	0	0	0	1
Below T1	0	0	0	0

### Safety Register Settings

The IC contains a SAFETY register (REG06h) that prevents the values in OREG (REG02h[7:2]) and IOCHARGE (REG04h[7:4]) from exceeding the values of VSAFE (REG06h[3:0]) and ISAFE (REG06h[7:4]) in the SAFETY register.

After  $V_{BAT}$  rises above  $V_{SHORT}$ , the SAFETY register is loaded with its default value and may be written to only before writing to any other register. The same 8-bit value should be written to the SAFETY register twice to set the register value. After writing to any other register, the SAFETY register is locked until  $V_{BAT}$  falls below  $V_{SHORT}$ .

If the host attempts to write a value higher than VSAFE or ISAFE to OREG or  $I_{CHARGE}$ , respectively; the VSAFE, ISAFE value appears as the OREG,  $I_{CHARGE}$  register value, respectively.

The Safety register is reset when the battery is below 3.0 V and power is removed from the  $V_{BUS}$  if  $CE\# = "1"$ . The

Safety register can be re-written to if it is the first I2C write anytime after the VBUS removal.

See VSAFE and ISAFE Register Bit Definitions

## Thermal Regulation and Shutdown

When the IC's junction temperature reaches TCF (about 120°C), the charger reduces its output current to 550 mA to prevent overheating. If the temperature increases beyond T<sub>SHUTDOWN</sub>; charging is suspended, the FAULT bits are set to 101, and STAT is pulsed high. In Suspend Mode, all timers stop and the state of the IC's logic is preserved. Charging resumes at programmed current after the die cools to about 120°C.

Note that as power dissipation increases, the effective  $\theta_{JA}$  decreases due to the larger difference between the die temperature and ambient.

## Charge Mode Input Supply Protection

### Input Supply Low-Voltage Detection

The IC continuously monitors V<sub>BUS</sub> during charging. If V<sub>BUS</sub> falls below V<sub>IN(MIN)2</sub>, the IC:

1. Terminates charging
2. Pulses the STAT pin, sets the STAT bits to "11", and sets the FAULT bits to "011".

If V<sub>BUS</sub> recovers above the V<sub>IN(MIN)1</sub> rising threshold after time t<sub>INT</sub> (about two seconds), the charging process is repeated. This function prevents the USB power bus from collapsing or oscillating when the IC is connected to a suspended USB port or a low-current-capable OTG device.

### Input Over-Voltage Detection

When the V<sub>BUS</sub> exceeds VBUS<sub>OVp</sub>, the IC:

1. Turns off Q3
2. Suspends charging
3. Sets the FAULT bits to "001", sets the STAT bits to "11", and pulses the STAT pin.

When VBUS falls about 100 mV below VBUS<sub>OVp</sub>, the fault is cleared and charging resumes after VBUS is revalidated.

## SYS Short During Discharge / Supplemental Mode

Caution should be taken to ensure the SYS pin is not shorted when connected to a battery. This condition can induce high current flow through the BATFET (Q4) and the external FET (Q5) until the battery's own safety circuit trips. The resulting high current can damage the IC.

## Charge Mode Battery Detection & Protection

### V<sub>BAT</sub> Over-Voltage Protection

The OREG voltage regulation loop prevents V<sub>BAT</sub> from overshooting V<sub>OREG</sub> by more than 50 mV when the battery is removed. When the PWM charger runs with no battery, the TE bit is not set and a battery is inserted that is charged to a voltage higher than V<sub>OREG</sub>; PWM pulses stop. If no further pulses occur for 30 ms, the IC sets the FAULT bits to "100", sets the STAT bits to "11", and pulses the STAT pin

### Battery Detection during Charging

The IC can detect the presence, absence, or removal of a battery if the termination bit (TE) is set to "1" and CE# = "0". During normal charging, once V<sub>BAT</sub> is close to V<sub>OREG</sub> and the charge current falls below I<sub>TERM</sub>; the PWM charger continues to provide power to SYS and Q4 is turned off. It then turns on a discharge current, I<sub>DETECT</sub>, for t<sub>DETECT</sub>. If V<sub>BAT</sub> is still above V<sub>OREG</sub> - V<sub>RCH</sub>, the battery is present and the IC sets the STAT bits to "10" (Charge Done). If V<sub>BAT</sub> is below V<sub>OREG</sub> - V<sub>RCH</sub>, the battery is absent and the IC:

1. Sets the charging parameters to their default values.
2. Sets the FAULT bits to "111" (Battery Absent) and sets the NOBAT bit.
3. If EOC = "0", the IC turns off the PWM for t<sub>INT</sub>, then resumes charging and retries Battery Detection. If the battery is still absent, the process repeats with the "No Battery" fault re-enunciated.
4. If EOC = "1", the PWM remains on to provide power to SYS, but charge termination and the battery absent test are performed every t<sub>INT</sub>.

### Linear Charging

If the battery voltage is below the short-circuit threshold (V<sub>SHORT</sub>); a linear current source, I<sub>SHORT</sub>, charges V<sub>BAT</sub> until V<sub>BAT</sub> > V<sub>SHORT</sub>.

## Production Test Mode (PTM)

PTM provides 4.20 V at up to 2.3 A to VBAT when V<sub>BUS</sub> = 5.5 V ±5%.

The IC enters PTM when the PROD (REG05h[6]) bit is set after the NOBAT (REG11h[3]) bit has been set. The NOBAT bit indicates that the IC has detected battery absence. A battery absence detection test is performed automatically at current termination. The steps for entering PTM should include: set the TE (REG01h[3]) bit high, set the CE# (REG01h[2]) bit low, wait for the NOBAT bit to set HIGH, then set the PROD bit to "1" to enter PTM. Battery absence detection is completed within 500 ms from the time that CE# is set.

In PTM, the GATE bit (REG11h[7]) is LOW, Q5 is on, and all auxiliary control loops are disabled. Only the OREG loop is active, which controls V<sub>BAT</sub> to 4.20 V, regardless of the OREG register setting. Thermal shutdown remains active.

During PTM, high current pulses (load currents greater than 1.5 A) must be limited to 20% duty cycle with a minimum period of 10 ms.

## Boost Mode

Boost Mode can be enabled if the IC is in 32-Second Mode by setting the OPA\_MODE REG01h[0]) bit HIGH and clearing the HZ\_MODE bit.

**Table 11. Enabling Boost**

HZ_MODE	OPA_MODE	BOOST
0	1	Enabled
1	X	Disabled
X	0	Disabled

To remain in Boost Mode, the TMR\_RST must be set by the host before the t<sub>32S</sub> timer times out. If t<sub>32S</sub> times out in Boost Mode; the IC resets all registers, pulses the STAT pin, sets the FAULT bits to 110, and resets the BOOST bit. VBUS POR or reading R0 clears the fault condition.

## Boost PWM Control

The IC uses a minimum on-time and computed minimum off-time to regulate V<sub>BUS</sub>. The regulator achieves excellent transient response by employing current-mode modulation. This technique causes the regulator to exhibit a load line. During fast charging, the output voltage drops slightly as the input current rises. With a constant V<sub>BAT</sub>, this appears as a constant output resistance.

The “droop” caused by the output resistance when a load is applied allows the regulator to respond smoothly to load transients with no undershoot from the load line. This can be seen in Figure 31 and Figure 38.

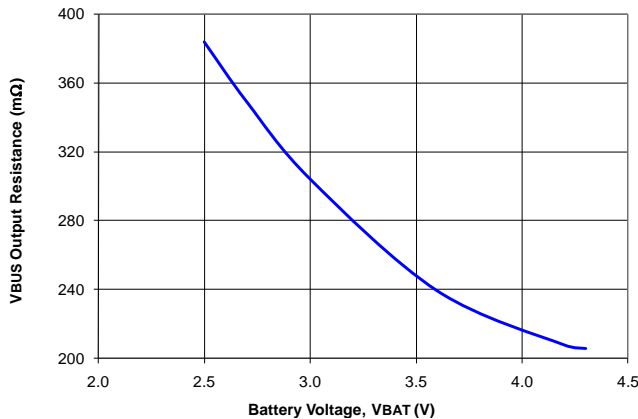

**Figure 38. Output Resistance (R<sub>OUT</sub>)**

V<sub>BUS</sub> as a function of I<sub>LOAD</sub> can be computed when the regulator is in PWM Mode (continuous conduction) as:

$$V_{OUT} = 5.07 - R_{OUT} \cdot I_{LOAD} \quad \text{EQ. 1}$$

At V<sub>BAT</sub>=3.0 V and I<sub>LOAD</sub>=300 mA, V<sub>BUS</sub> drops to:

$$V_{OUT} = 5.07 - 0.30 \cdot 0.3 = 4.98V \quad \text{EQ. 2}$$

At V<sub>BAT</sub>=3.6 V and I<sub>LOAD</sub>=500 mA, V<sub>BUS</sub> drops to:

$$V_{OUT} = 5.07 - 0.24 \cdot 0.5 = 4.95V \quad \text{EQ. 3}$$

## PFM Mode

If V<sub>BUS</sub> > VREF<sub>BOOST</sub> (nominally 5.07 V) when the minimum off-time ends, the regulator enters PFM Mode. Boost pulses are inhibited until V<sub>BUS</sub> < VREF<sub>BOOST</sub>. The minimum on-time is increased to enable the output to pump up sufficiently with each PFM boost pulse. Therefore, the regulator behaves like a constant on-time regulator, with the bottom of its output voltage ripple at 5.07 V in PFM Mode.

**Table 12. Boost PWM Operating States**

Mode	Description	Invoked When
LIN	Linear Startup	V <sub>BAT</sub> > V <sub>BUS</sub>
SS	Boost Soft-Start	V <sub>BUS</sub> < V <sub>BST</sub>
BST	Boost Operating Mode	V <sub>BAT</sub> > UVLO <sub>BST</sub> and SS Completed

## Startup

When the boost regulator is shut down, current flow is prevented from VBAT to VBUS, as well as reverse flow from VBUS to VBAT.

## LIN State

When EN rises, if VBAT > UVLOBST; the regulator first attempts to bring PMID within 400 mV of VBAT using an internal 450 mA current limited source from VBAT (LIN State). If PMID has not achieved VBAT – 400 mV after 560 μs, a fault state is initiated.

## SS State

When PMID > V<sub>BAT</sub> – 400 mV, the boost regulator begins switching with a reduced peak current limit of about 50% of its normal current limit. The output slews up until V<sub>BUS</sub> is within 5% of its setpoint; at which time, the regulation loop is closed and the current limit is set to 100%.

If the output fails to achieve 95% of its setpoint (V<sub>BST</sub>) within 128 μs, the current limit is increased to 100%. If the output fails to achieve 95% of its setpoint after this second 384 μs period, a fault state is initiated.

## BST State

This is the normal operating mode of the regulator. The regulator uses a minimum t<sub>OFF</sub>-minimum t<sub>ON</sub> modulation scheme. The minimum t<sub>OFF</sub> is proportional to  $\frac{V_{IN}}{V_{OUT}}$ , which

keeps the regulator’s switching frequency reasonably constant in CCM. t<sub>ON(MIN)</sub> is proportional to V<sub>BAT</sub> and is a higher value if the inductor current reached 0 before t<sub>OFF(MIN)</sub> in the prior cycle.

To ensure V<sub>BUS</sub> does not overshoot the regulation point, the boost switch remains off as long as V<sub>FB</sub> > V<sub>REF(BST)</sub>.

## Boost Faults

If a BOOST fault occurs:

1. The STAT pin pulses.
2. OPA\_MODE bit is reset.
3. The power stage is in High-Impedance Mode.
4. The FAULT bits (REG0[2:0]) are set per Table 13.

### Restart After Boost Faults

OPA\_MODE is reset on boost faults. Boost Mode can only be re-enabled by setting the OPA\_MODE bit.

**Table 13. Fault Bits During Boost Mode**

Fault Bit			Fault (REG00h[2:0]) Description
B2	B1	B0	
0	0	0	Normal (no fault)
0	0	1	$V_{BUS} > V_{BUS_{OVP}}$
0	1	0	$V_{BUS}$ fails to achieve the voltage required to advance to the next state during soft-start or sustained ( $>50 \mu s$ ) current limit during the BST state.
0	1	1	$V_{BAT} < UVLO_{BST}$
1	0	0	NA: This code does not appear.
1	0	1	Thermal shutdown
1	1	0	Timer fault; all registers reset.
1	1	1	NA: This code does not appear.

### I<sup>2</sup>C Interface

The FAN54053's serial interface is compatible with Standard, Fast, Fast Plus, and High-Speed Mode I<sup>2</sup>C bus specifications. The FAN54053 SCL line is an input and the SDA line is a bi-directional open-drain output; it can only pull down the bus when active. The SDA line only pulls LOW during data reads and when signaling ACK. All data is shifted in MSB (bit 7) first.

### Slave Address

**Table 14. I<sup>2</sup>C Slave Address Byte**

7	6	5	4	3	2	1	0
1	1	0	1	0	1	1	R/W

In hex notation, the slave address assumes a 0 LSB. The hex slave address is D6h for all parts in the family. Other slave addresses can be accommodated upon request. Contact a Fairchild Semiconductor representative.

### Bus Timing

Shown in Figure 39, data is normally transferred when SCL is LOW. Data is clocked in on the rising edge of SCL. Typically, data transitions shortly at or after the falling edge of SCL to allow ample time for the data to set up before the next SCL rising edge.

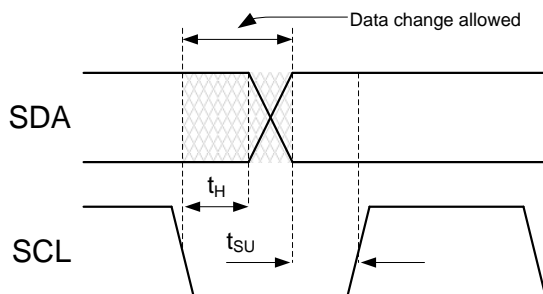

**Figure 39. Data Transfer Timing**

Each bus transaction begins and ends with SDA and SCL HIGH. A transaction begins with a START condition, which is defined as SDA transitioning from 1 to 0 with SCL HIGH, as shown in Figure 40.

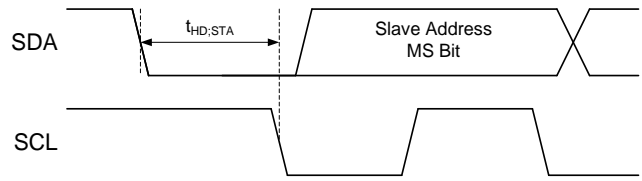

**Figure 40. Start Bit**

Transactions end with a STOP condition, which is SDA transitioning from 0 to 1 with SCL HIGH, as shown in Figure 41.

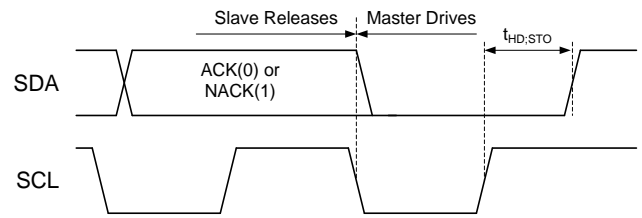

**Figure 41. Stop Bit**

During a read from the FAN54053 Figure 44 the master issues a Repeated Start after sending the register address and before resending the slave address. The Repeated Start is a 1-to-0 transition on SDA while SCL is HIGH, as shown in Figure 42.

## High-Speed (HS) Mode

The protocols for High-Speed (HS), Low-Speed (LS), and Fast-Speed (FS) Modes are identical except the bus speed for HS Mode is 3.4 MHz. HS Mode is entered when the bus master sends the HS master code 00001XXX after a start condition. The master code is sent in Fast or Fast Plus Mode (less than 1 MHz clock); slaves do not ACK the transmission.

The master then generates a repeated start condition that causes all slaves on the bus to switch to HS Mode. The master then sends I<sup>2</sup>C packets, as described above, using the HS Mode clock rate and timing.

The bus remains in HS Mode until a stop bit is sent by the master. While in HS Mode, packets are separated by repeated start conditions Figure 42.

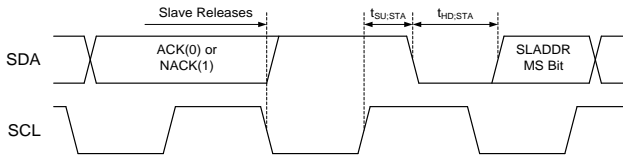

Figure 42. Repeated Start Timing

## Read and Write Transactions

The figures below outline the sequences for data read and write. Bus control is signified by the shading of the packet, defined as Master Drives Bus and Slave Drives Bus. All addresses and data are MSB first.

Table 15. Bit Definitions for Figure 43- Figure 46

Symbol	Definition
S	START, see Figure 40
A	ACK. The slave drives SDA to 0 to acknowledge the preceding packet.
$\bar{A}$	NACK. The slave sends a 1 to NACK the preceding packet.
R	Repeated START, see Figure 42
P	STOP, see Figure 41

## Multi-Byte (Sequential) Read and Write Transactions

### Sequential Write

The Slave Address, Reg Addr address, and the first data byte are transmitted to the FAN54053 in the same way as in a byte write Figure 43. However, instead of generating a Stop condition, the master transmits additional bytes that are written to consecutive sequential registers after the falling edge of the eighth bit. After the last byte written and its ACK bit received, the master issues a STOP bit. The IC contains an 8-bit counter that increments the address pointer after each byte is written.



## Register Descriptions

The Twelve user-accessible IC registers are defined in Table 17.

**Table 16. I<sup>2</sup>C Register Map**

Register		BIT NAME							
Name	REG#	7	6	5	4	3	2	1	0
CONTROL0	0H	TMR_RST	EN_STAT	STAT		BOOST	FAULT		
CONTROL1	1H	IBUSLIM		VLOWV		TE	CE#	HZ_MODE	OPA_MODE
OREG	2H	OREG						DBAT_B	EOC
IC_INFO	3H	Vendor Code		PN			REVISION		
IBAT	4H	RESET	IOCHARGE				ITERM		
VBUS_CONTROL	5H	Reserved	PROD	IO_LEVEL	VBUS_CON	SP	VBUSLIM		
SAFETY	6H	ISAFE				VSAFE			
POST_CHARGING	7H	Reserved	Reserved	VBUS_LOAD		PC_EN	PC_IT		
MONITOR0	10H	ITERM_CMP	VBAT_CMP	LINCHG	T_120	ICHG	IBUS	VBUS_VALID	CV
MONITOR1	11H	GATE	VBAT	POK_B	DIS_LEVEL	NOBAT	PC_ON	Reserved	Reserved
NTC	12H	Reserved		TEMP_DIS	NTC_OK	NTC4	NTC3	NTC2	NTC1
WD_CONTROL	13H	Reserved	Reserved	Reserved	Reserved	Reserved	EN_REG	WD_DIS	Reserved
RESTART	FA	RESTART							





Bit	Name	Value	Type	Description																	
<b>CONTROL1</b>				<b>Register Address: 01h(1)      Default Value=0011 0100 (34h)</b>																	
7:6	IBUSLIM	00	R/W	Input current limit																	
				<table border="1"> <thead> <tr> <th colspan="2">Bit</th> <th rowspan="2">I<sub>BUSLIM</sub> (mA)</th> </tr> <tr> <th>7</th> <th>6</th> </tr> </thead> <tbody> <tr> <td>0</td> <td>0</td> <td>475</td> </tr> <tr> <td>0</td> <td>1</td> <td>760</td> </tr> <tr> <td>1</td> <td>0</td> <td>1080</td> </tr> <tr> <td>1</td> <td>1</td> <td>No Limit</td> </tr> </tbody> </table>	Bit		I <sub>BUSLIM</sub> (mA)	7	6	0	0	475	0	1	760	1	0	1080	1	1	No Limit
				Bit		I <sub>BUSLIM</sub> (mA)															
				7	6																
				0	0	475															
0	1	760																			
1	0	1080																			
1	1	No Limit																			
5:4	VLOWV	11	R/W	Weak battery voltage threshold																	
				<table border="1"> <thead> <tr> <th colspan="2">Bit</th> <th rowspan="2">V<sub>LOWV</sub> (V)</th> </tr> <tr> <th>5</th> <th>4</th> </tr> </thead> <tbody> <tr> <td>0</td> <td>0</td> <td>3.4</td> </tr> <tr> <td>0</td> <td>1</td> <td>3.5</td> </tr> <tr> <td>1</td> <td>0</td> <td>3.6</td> </tr> <tr> <td>1</td> <td>1</td> <td>3.7</td> </tr> </tbody> </table>	Bit		V <sub>LOWV</sub> (V)	5	4	0	0	3.4	0	1	3.5	1	0	3.6	1	1	3.7
				Bit		V <sub>LOWV</sub> (V)															
				5	4																
				0	0	3.4															
0	1	3.5																			
1	0	3.6																			
1	1	3.7																			
3	TE	0	R/W	Setting the TE bit to a 1 will enable Charge Termination.																	
2	CE#	1	R/W	This is an active low bit and by setting the bit to a “0” will enable Charging. When the bit is reset, it will return to the “1” state and charging will be disabled.																	
1	HZ_MODE	0	R/W	Setting this bit to a “1” puts the device in High Impedance mode.																	
0	OPA_MODE	0	R/W	The device is in Charge Mode when the OPA_MODE bit = 0 and in Boost Operation when the bit = 1.																	
				<i>See Table 11</i>																	

Bit	Name	Value	Type	Description																																																																																																																																																									
<b>OREG</b> <span style="float: right;">Register Address: 02h(2)      Default Value=0000 1000 (08h)</span>																																																																																																																																																													
7:2	OREG	000010	R/W	Charger output “float” voltage; programmable from 3.51 to 4.45 V in 20 mV increments.																																																																																																																																																									
				<table border="1"> <thead> <tr> <th>Dec</th> <th>Hex</th> <th>V<sub>OREG</sub></th> <th>Dec</th> <th>Hex</th> <th>V<sub>OREG</sub></th> <th>Dec</th> <th>Hex</th> <th>V<sub>OREG</sub></th> </tr> </thead> <tbody> <tr><td>0</td><td>00</td><td>3.51</td><td>16</td><td>10</td><td>3.83</td><td>32</td><td>20</td><td>4.15</td></tr> <tr><td>1</td><td>01</td><td>3.53</td><td>17</td><td>11</td><td>3.85</td><td>33</td><td>21</td><td>4.17</td></tr> <tr><td><b>2</b></td><td><b>02</b></td><td><b>3.55</b></td><td>18</td><td>12</td><td>3.87</td><td>34</td><td>22</td><td>4.19</td></tr> <tr><td>3</td><td>03</td><td>3.57</td><td>19</td><td>13</td><td>3.89</td><td>35</td><td>23</td><td>4.21</td></tr> <tr><td>4</td><td>04</td><td>3.59</td><td>20</td><td>14</td><td>3.91</td><td>36</td><td>24</td><td>4.23</td></tr> <tr><td>5</td><td>05</td><td>3.61</td><td>21</td><td>15</td><td>3.93</td><td>37</td><td>25</td><td>4.25</td></tr> <tr><td>6</td><td>06</td><td>3.63</td><td>22</td><td>16</td><td>3.95</td><td>38</td><td>26</td><td>4.27</td></tr> <tr><td>7</td><td>07</td><td>3.65</td><td>23</td><td>17</td><td>3.97</td><td>39</td><td>27</td><td>4.29</td></tr> <tr><td>8</td><td>08</td><td>3.67</td><td>24</td><td>18</td><td>3.99</td><td>40</td><td>28</td><td>4.31</td></tr> <tr><td>9</td><td>09</td><td>3.69</td><td>25</td><td>19</td><td>4.01</td><td>41</td><td>29</td><td>4.33</td></tr> <tr><td>10</td><td>0A</td><td>3.71</td><td>26</td><td>1A</td><td>4.03</td><td>42</td><td>2A</td><td>4.35</td></tr> <tr><td>11</td><td>0B</td><td>3.73</td><td>27</td><td>1B</td><td>4.05</td><td>43</td><td>2B</td><td>4.37</td></tr> <tr><td>12</td><td>0C</td><td>3.75</td><td>28</td><td>1C</td><td>4.07</td><td>44</td><td>2C</td><td>4.39</td></tr> <tr><td>13</td><td>0D</td><td>3.77</td><td>29</td><td>1D</td><td>4.09</td><td>45</td><td>2D</td><td>4.41</td></tr> <tr><td>14</td><td>0E</td><td>3.79</td><td>30</td><td>1E</td><td>4.11</td><td>46</td><td>2E</td><td>4.43</td></tr> <tr><td>15</td><td>0F</td><td>3.81</td><td>31</td><td>1F</td><td>4.13</td><td>47-63</td><td>2F-3F</td><td>4.45</td></tr> </tbody> </table>	Dec	Hex	V <sub>OREG</sub>	Dec	Hex	V <sub>OREG</sub>	Dec	Hex	V <sub>OREG</sub>	0	00	3.51	16	10	3.83	32	20	4.15	1	01	3.53	17	11	3.85	33	21	4.17	<b>2</b>	<b>02</b>	<b>3.55</b>	18	12	3.87	34	22	4.19	3	03	3.57	19	13	3.89	35	23	4.21	4	04	3.59	20	14	3.91	36	24	4.23	5	05	3.61	21	15	3.93	37	25	4.25	6	06	3.63	22	16	3.95	38	26	4.27	7	07	3.65	23	17	3.97	39	27	4.29	8	08	3.67	24	18	3.99	40	28	4.31	9	09	3.69	25	19	4.01	41	29	4.33	10	0A	3.71	26	1A	4.03	42	2A	4.35	11	0B	3.73	27	1B	4.05	43	2B	4.37	12	0C	3.75	28	1C	4.07	44	2C	4.39	13	0D	3.77	29	1D	4.09	45	2D	4.41	14	0E	3.79	30	1E	4.11	46	2E	4.43	15	0F	3.81	31	1F	4.13	47-63	2F-3F	4.45
				Dec	Hex	V <sub>OREG</sub>	Dec	Hex	V <sub>OREG</sub>	Dec	Hex	V <sub>OREG</sub>																																																																																																																																																	
				0	00	3.51	16	10	3.83	32	20	4.15																																																																																																																																																	
				1	01	3.53	17	11	3.85	33	21	4.17																																																																																																																																																	
				<b>2</b>	<b>02</b>	<b>3.55</b>	18	12	3.87	34	22	4.19																																																																																																																																																	
				3	03	3.57	19	13	3.89	35	23	4.21																																																																																																																																																	
				4	04	3.59	20	14	3.91	36	24	4.23																																																																																																																																																	
				5	05	3.61	21	15	3.93	37	25	4.25																																																																																																																																																	
				6	06	3.63	22	16	3.95	38	26	4.27																																																																																																																																																	
				7	07	3.65	23	17	3.97	39	27	4.29																																																																																																																																																	
				8	08	3.67	24	18	3.99	40	28	4.31																																																																																																																																																	
				9	09	3.69	25	19	4.01	41	29	4.33																																																																																																																																																	
				10	0A	3.71	26	1A	4.03	42	2A	4.35																																																																																																																																																	
				11	0B	3.73	27	1B	4.05	43	2B	4.37																																																																																																																																																	
				12	0C	3.75	28	1C	4.07	44	2C	4.39																																																																																																																																																	
13	0D	3.77	29	1D	4.09	45	2D	4.41																																																																																																																																																					
14	0E	3.79	30	1E	4.11	46	2E	4.43																																																																																																																																																					
15	0F	3.81	31	1F	4.13	47-63	2F-3F	4.45																																																																																																																																																					
1	DBAT_B	0	R/W	Indicates that the IC detected a dead battery after VBUS_POR. Writing a 0 to this bit is ignored.																																																																																																																																																									
		1		The IC sets this bit to 1 if a dead battery ( $V_{BAT} < V_{SHORT}$ ) was not detected at VBUS_POR. If the host sets this bit while the IC is charging the battery and DBAT_B is LOW, normal Precharge or Fast charging proceeds.																																																																																																																																																									
0	EOC	0	R/W	If TE = “1”, and no battery is detected at I <sub>TERM</sub> , the IC turns off the PWM for T <sub>INT</sub> , then resumes charging and retries Battery Detection. If the battery is still absent, the process repeats with the “No Battery” fault re-enunciated, and sets the charging parameters to the default values (see Charge State Flow Chart)																																																																																																																																																									
		1		If no battery is detected when a full battery (end of charge) is reached, the PWM charger stays on, allowing the host processor to continue to run with no battery.																																																																																																																																																									
<b>IC_INFO</b> <span style="float: right;">Register Address: 03h(3)      Default Value=1001 0XXX (9Xh)</span>																																																																																																																																																													
7:6	Vendor Code	10	R	Identifies Fairchild Semiconductor as the IC supplier																																																																																																																																																									
5:3	PN	010	R	Part number bits, <i>see the Ordering Information</i>																																																																																																																																																									
2:0	REV		R	IC Revision, revision 1.X, where X is the decimal of these three bits																																																																																																																																																									

Bit	Name	Value	Type	Description																																																																
<b>IBAT</b>				<b>Register Address: 04h(4)</b> <b>Default Value=1000 0001 (81h)</b>																																																																
7	RESET	1	W	<table border="1"> <thead> <tr> <th>Conditions</th> <th>Functionality</th> </tr> </thead> <tbody> <tr> <td>Valid <math>V_{BUS}</math>, <math>V_{BAT} &gt; V_{LOWV}</math></td> <td>Setting the RESET bit clears all registers (except SAFETY and CE#) including WD_DIS and HZ_MODE.</td> </tr> <tr> <td>Valid <math>V_{BUS}</math>, <math>V_{BAT} &lt; V_{LOWV}</math></td> <td>Setting the RESET bit clears all registers (except SAFETY) including WD_DIS, HZ_MODE and CE#.</td> </tr> <tr> <td>Absent <math>V_{BUS}</math></td> <td>Setting the RESET bit resets all registers (except SAFETY and CE#) including WD_DIS and HZ_MODE.</td> </tr> </tbody> </table>	Conditions	Functionality	Valid $V_{BUS}$ , $V_{BAT} > V_{LOWV}$	Setting the RESET bit clears all registers (except SAFETY and CE#) including WD_DIS and HZ_MODE.	Valid $V_{BUS}$ , $V_{BAT} < V_{LOWV}$	Setting the RESET bit clears all registers (except SAFETY) including WD_DIS, HZ_MODE and CE#.	Absent $V_{BUS}$	Setting the RESET bit resets all registers (except SAFETY and CE#) including WD_DIS and HZ_MODE.																																																								
				Conditions	Functionality																																																															
				Valid $V_{BUS}$ , $V_{BAT} > V_{LOWV}$	Setting the RESET bit clears all registers (except SAFETY and CE#) including WD_DIS and HZ_MODE.																																																															
				Valid $V_{BUS}$ , $V_{BAT} < V_{LOWV}$	Setting the RESET bit clears all registers (except SAFETY) including WD_DIS, HZ_MODE and CE#.																																																															
Absent $V_{BUS}$	Setting the RESET bit resets all registers (except SAFETY and CE#) including WD_DIS and HZ_MODE.																																																																			
Writing a 0 has no effect; read returns 1																																																																				
6:3	IOCHARGE	0000	R/W	Programs the maximum charge current (550 mA default) <table border="1"> <thead> <tr> <th colspan="4">Bit</th> <th rowspan="2">IOCHARGE (mA)</th> </tr> <tr> <th>6</th> <th>5</th> <th>4</th> <th>3</th> </tr> </thead> <tbody> <tr> <td>0</td> <td>0</td> <td>0</td> <td>0</td> <td>550</td> </tr> <tr> <td>0</td> <td>0</td> <td>0</td> <td>1</td> <td>650</td> </tr> <tr> <td>0</td> <td>0</td> <td>1</td> <td>0</td> <td>750</td> </tr> <tr> <td>0</td> <td>0</td> <td>1</td> <td>1</td> <td>850</td> </tr> <tr> <td>0</td> <td>1</td> <td>0</td> <td>0</td> <td>950</td> </tr> <tr> <td>0</td> <td>1</td> <td>0</td> <td>1</td> <td>1,050</td> </tr> <tr> <td>0</td> <td>1</td> <td>1</td> <td>0</td> <td>1,150</td> </tr> <tr> <td>0</td> <td>1</td> <td>1</td> <td>1</td> <td>1,250</td> </tr> <tr> <td>1</td> <td>0</td> <td>0</td> <td>0</td> <td>1,350</td> </tr> <tr> <td>1</td> <td>0</td> <td>0</td> <td>1</td> <td>1,450</td> </tr> <tr> <td colspan="4">1010-1111</td> <td>1,550</td> </tr> </tbody> </table>	Bit				IOCHARGE (mA)	6	5	4	3	0	0	0	0	550	0	0	0	1	650	0	0	1	0	750	0	0	1	1	850	0	1	0	0	950	0	1	0	1	1,050	0	1	1	0	1,150	0	1	1	1	1,250	1	0	0	0	1,350	1	0	0	1	1,450	1010-1111				1,550
				Bit				IOCHARGE (mA)																																																												
				6	5	4	3																																																													
				0	0	0	0	550																																																												
				0	0	0	1	650																																																												
				0	0	1	0	750																																																												
				0	0	1	1	850																																																												
				0	1	0	0	950																																																												
				0	1	0	1	1,050																																																												
				0	1	1	0	1,150																																																												
				0	1	1	1	1,250																																																												
				1	0	0	0	1,350																																																												
				1	0	0	1	1,450																																																												
1010-1111				1,550																																																																
2:0	ITERM	001	R/W	Sets the current used for charging termination <table border="1"> <thead> <tr> <th colspan="3">Bit</th> <th rowspan="2">ITERM (mA)</th> </tr> <tr> <th>2</th> <th>1</th> <th>0</th> </tr> </thead> <tbody> <tr> <td>0</td> <td>0</td> <td>0</td> <td>50</td> </tr> <tr> <td>0</td> <td>0</td> <td>1</td> <td>100</td> </tr> <tr> <td>0</td> <td>1</td> <td>0</td> <td>150</td> </tr> <tr> <td>0</td> <td>1</td> <td>1</td> <td>200</td> </tr> <tr> <td>1</td> <td>0</td> <td>0</td> <td>250</td> </tr> <tr> <td>1</td> <td>0</td> <td>1</td> <td>300</td> </tr> <tr> <td>1</td> <td>1</td> <td>0</td> <td>350</td> </tr> <tr> <td>1</td> <td>1</td> <td>1</td> <td>400</td> </tr> </tbody> </table>	Bit			ITERM (mA)	2	1	0	0	0	0	50	0	0	1	100	0	1	0	150	0	1	1	200	1	0	0	250	1	0	1	300	1	1	0	350	1	1	1	400																									
				Bit			ITERM (mA)																																																													
				2	1	0																																																														
				0	0	0	50																																																													
				0	0	1	100																																																													
				0	1	0	150																																																													
				0	1	1	200																																																													
				1	0	0	250																																																													
				1	0	1	300																																																													
				1	1	0	350																																																													
1	1	1	400																																																																	

Bit	Name	Value	Type	Description																																																																										
<b>VBUS_CONTROL</b> <span style="float: right;">Register Address: 05h(5)      Default Value=001X X100</span>																																																																														
7	Reserved	0	R	This bit always returns 0																																																																										
6	PROD	0	R/W	Charger operates in Normal Mode.																																																																										
		1		Charger operates in Production Test Mode.																																																																										
5	IO_LEVEL	0	R/W	Battery current is controlled by I <sub>CHARGE</sub> and I <sub>BUSLIM</sub> bits while Fast Charging. During Precharge Mode, battery current is limited to 450 mA when I <sub>CHARGE</sub> ≤ 750 mA and 730 mA when I <sub>CHARGE</sub> > 750 mA. I <sub>BUSLIM</sub> bits must be set to “10” or “11” or IO_LEVEL current will remain at 200 mA.																																																																										
		1		Battery current control is set to 200 mA for Fast Charge and Precharge Mode.																																																																										
4	VBUS_CON		R	1 Indicates that V <sub>BUS</sub> is above 4.4 V (rising) or 3.8 V (falling). When VBUS_CON changes from 0 to 1, a STAT pulse occurs.																																																																										
3	VLIM	0	R	VBUS control loop is not active (V <sub>BUS</sub> is able to stay above V <sub>BUSLIM</sub> )																																																																										
		1		VBUS control loop is active and V <sub>BUS</sub> is being regulated to V <sub>BUSLIM</sub>																																																																										
2:0	VBUSLIM	100	R/W	VBUS control voltage reference																																																																										
				<table border="1" style="margin-left: auto; margin-right: auto;"> <thead> <tr> <th colspan="3">Bit</th> <th rowspan="2">V<sub>BUSLIM</sub> (V)</th> </tr> <tr> <th>2</th> <th>1</th> <th>0</th> </tr> </thead> <tbody> <tr><td>0</td><td>0</td><td>0</td><td>4.213</td></tr> <tr><td>0</td><td>0</td><td>1</td><td>4.293</td></tr> <tr><td>0</td><td>1</td><td>0</td><td>4.373</td></tr> <tr><td>0</td><td>1</td><td>1</td><td>4.453</td></tr> <tr><td>1</td><td>0</td><td>0</td><td>4.533</td></tr> <tr><td>1</td><td>0</td><td>1</td><td>4.613</td></tr> <tr><td>1</td><td>1</td><td>0</td><td>4.693</td></tr> <tr><td>1</td><td>1</td><td>1</td><td>4.773</td></tr> </tbody> </table>	Bit			V <sub>BUSLIM</sub> (V)	2	1	0	0	0	0	4.213	0	0	1	4.293	0	1	0	4.373	0	1	1	4.453	1	0	0	4.533	1	0	1	4.613	1	1	0	4.693	1	1	1	4.773																																			
				Bit			V <sub>BUSLIM</sub> (V)																																																																							
				2	1	0																																																																								
				0	0	0	4.213																																																																							
				0	0	1	4.293																																																																							
				0	1	0	4.373																																																																							
				0	1	1	4.453																																																																							
				1	0	0	4.533																																																																							
				1	0	1	4.613																																																																							
1	1	0	4.693																																																																											
1	1	1	4.773																																																																											
<b>SAFETY</b> <span style="float: right;">Register Address: 06h(6)      Default Value=0100 0000 (4Ah)</span>																																																																														
7:4	ISAFE	0110	R/W	Sets the maximum I <sub>CHARGE</sub> value used by the control circuit																																																																										
				<table border="1" style="margin-left: auto; margin-right: auto;"> <thead> <tr> <th colspan="4">Bit</th> <th rowspan="2">I<sub>CHARGE(MAX)</sub> (mA)</th> </tr> <tr> <th>7</th> <th>6</th> <th>5</th> <th>4</th> </tr> </thead> <tbody> <tr><td>0</td><td>0</td><td>0</td><td>0</td><td>550</td></tr> <tr><td>0</td><td>0</td><td>0</td><td>1</td><td>650</td></tr> <tr><td>0</td><td>0</td><td>1</td><td>0</td><td>750</td></tr> <tr><td>0</td><td>0</td><td>1</td><td>1</td><td>850</td></tr> <tr><td>0</td><td>1</td><td>0</td><td>0</td><td>950</td></tr> <tr><td>0</td><td>1</td><td>0</td><td>1</td><td>1,050</td></tr> <tr><td>0</td><td>1</td><td>1</td><td>0</td><td>1,050</td></tr> <tr><td>0</td><td>1</td><td>1</td><td>1</td><td>1,250</td></tr> <tr><td>1</td><td>0</td><td>0</td><td>0</td><td>1,350</td></tr> <tr><td>1</td><td>0</td><td>0</td><td>1</td><td>1,450</td></tr> <tr><td colspan="4">1010-1111</td><td>1,550</td></tr> </tbody> </table>	Bit				I <sub>CHARGE(MAX)</sub> (mA)	7	6	5	4	0	0	0	0	550	0	0	0	1	650	0	0	1	0	750	0	0	1	1	850	0	1	0	0	950	0	1	0	1	1,050	0	1	1	0	1,050	0	1	1	1	1,250	1	0	0	0	1,350	1	0	0	1	1,450	1010-1111				1,550										
				Bit				I <sub>CHARGE(MAX)</sub> (mA)																																																																						
				7	6	5	4																																																																							
				0	0	0	0	550																																																																						
				0	0	0	1	650																																																																						
				0	0	1	0	750																																																																						
				0	0	1	1	850																																																																						
				0	1	0	0	950																																																																						
				0	1	0	1	1,050																																																																						
				0	1	1	0	1,050																																																																						
				0	1	1	1	1,250																																																																						
1	0	0	0	1,350																																																																										
1	0	0	1	1,450																																																																										
1010-1111				1,550																																																																										
3:0	VSAFE	1010	R/W	Sets the maximum V <sub>OREG</sub> used by the control circuit																																																																										
				<table border="1" style="margin-left: auto; margin-right: auto;"> <thead> <tr> <th colspan="4">Bit</th> <th rowspan="2">V<sub>OREG(MAX)</sub> (V)</th> </tr> <tr> <th>3</th> <th>2</th> <th>1</th> <th>0</th> </tr> </thead> <tbody> <tr><td>0</td><td>0</td><td>0</td><td>0</td><td>4.21</td></tr> <tr><td>0</td><td>0</td><td>0</td><td>1</td><td>4.23</td></tr> <tr><td>0</td><td>0</td><td>1</td><td>0</td><td>4.25</td></tr> <tr><td>0</td><td>0</td><td>1</td><td>1</td><td>4.27</td></tr> <tr><td>0</td><td>1</td><td>0</td><td>0</td><td>4.29</td></tr> <tr><td>0</td><td>1</td><td>0</td><td>1</td><td>4.31</td></tr> <tr><td>0</td><td>1</td><td>1</td><td>0</td><td>4.33</td></tr> <tr><td>0</td><td>1</td><td>1</td><td>1</td><td>4.35</td></tr> <tr><td>1</td><td>0</td><td>0</td><td>0</td><td>4.37</td></tr> <tr><td>1</td><td>0</td><td>0</td><td>1</td><td>4.39</td></tr> <tr><td>1</td><td>0</td><td>1</td><td>0</td><td>4.41</td></tr> <tr><td>1</td><td>0</td><td>1</td><td>1</td><td>4.43</td></tr> <tr><td colspan="4">1100-1111</td><td>4.45</td></tr> </tbody> </table>	Bit				V <sub>OREG(MAX)</sub> (V)	3	2	1	0	0	0	0	0	4.21	0	0	0	1	4.23	0	0	1	0	4.25	0	0	1	1	4.27	0	1	0	0	4.29	0	1	0	1	4.31	0	1	1	0	4.33	0	1	1	1	4.35	1	0	0	0	4.37	1	0	0	1	4.39	1	0	1	0	4.41	1	0	1	1	4.43	1100-1111				4.45
				Bit				V <sub>OREG(MAX)</sub> (V)																																																																						
				3	2	1	0																																																																							
				0	0	0	0	4.21																																																																						
				0	0	0	1	4.23																																																																						
				0	0	1	0	4.25																																																																						
				0	0	1	1	4.27																																																																						
				0	1	0	0	4.29																																																																						
				0	1	0	1	4.31																																																																						
				0	1	1	0	4.33																																																																						
				0	1	1	1	4.35																																																																						
				1	0	0	0	4.37																																																																						
				1	0	0	1	4.39																																																																						
1	0	1	0	4.41																																																																										
1	0	1	1	4.43																																																																										
1100-1111				4.45																																																																										

Bit	Name	Value	Type	Description																																							
<b>POST_CHARGING</b> <span style="float: right;">Register Address: 07h(7)      Default Value=0000 0001 (01h)</span>																																											
7:6	Reserved	00	R	These bits always return 0																																							
5:4	VBUS_LOAD	00	R/W	<p>After charger termination, in the charge done state, these bits control VBUS loading to improve detection of AC power removal from the AC adapter.</p> <table border="1" style="margin-left: 20px;"> <thead> <tr> <th>[5:4]</th> <th>VBUS Loading in Charge Done State:</th> </tr> </thead> <tbody> <tr> <td>00</td> <td>None</td> </tr> <tr> <td>01</td> <td>Load VBUS for 4 ms every two seconds</td> </tr> <tr> <td>10</td> <td>Load VBUS for 131 ms every two seconds</td> </tr> <tr> <td>11</td> <td>Load VBUS for 135 ms every two seconds</td> </tr> </tbody> </table>	[5:4]	VBUS Loading in Charge Done State:	00	None	01	Load VBUS for 4 ms every two seconds	10	Load VBUS for 131 ms every two seconds	11	Load VBUS for 135 ms every two seconds																													
[5:4]	VBUS Loading in Charge Done State:																																										
00	None																																										
01	Load VBUS for 4 ms every two seconds																																										
10	Load VBUS for 131 ms every two seconds																																										
11	Load VBUS for 135 ms every two seconds																																										
3	PC_EN	0	R/W	Post charging or background charging feature is disabled																																							
		1		Post charging or background charging feature is enabled																																							
2:0	PC_IT	001	R/W	<p>Sets the termination current for post charging</p> <table border="1" style="margin-left: 20px;"> <thead> <tr> <th colspan="3">Bit</th> <th rowspan="2">PC_IT (mA)</th> </tr> <tr> <th>2</th> <th>1</th> <th>0</th> </tr> </thead> <tbody> <tr> <td>0</td> <td>0</td> <td>0</td> <td>50</td> </tr> <tr> <td><b>0</b></td> <td><b>0</b></td> <td><b>1</b></td> <td><b>100</b></td> </tr> <tr> <td>0</td> <td>1</td> <td>0</td> <td>150</td> </tr> <tr> <td>0</td> <td>1</td> <td>1</td> <td>200</td> </tr> <tr> <td>1</td> <td>0</td> <td>0</td> <td>250</td> </tr> <tr> <td>1</td> <td>0</td> <td>1</td> <td>300</td> </tr> <tr> <td>1</td> <td>1</td> <td>0</td> <td>350</td> </tr> <tr> <td>1</td> <td>1</td> <td>1</td> <td>400</td> </tr> </tbody> </table>	Bit			PC_IT (mA)	2	1	0	0	0	0	50	<b>0</b>	<b>0</b>	<b>1</b>	<b>100</b>	0	1	0	150	0	1	1	200	1	0	0	250	1	0	1	300	1	1	0	350	1	1	1	400
Bit			PC_IT (mA)																																								
2	1	0																																									
0	0	0	50																																								
<b>0</b>	<b>0</b>	<b>1</b>	<b>100</b>																																								
0	1	0	150																																								
0	1	1	200																																								
1	0	0	250																																								
1	0	1	300																																								
1	1	0	350																																								
1	1	1	400																																								
<b>MONITOR0</b> <span style="float: right;">Register Address: 10h (16)      Default Value=XXX0 XXXX (XXh)</span>																																											
7	ITERM_CMP		R	ITERM comparator output, 1 when $I_{CHARGE} > I_{TERM}$ reference																																							
6	VBAT_CMP		R	Output of VBAT comparator, 1 when $V_{BAT} < V_{BUS}$																																							
5	LINCHG		R	1 when 30 mA linear charger ON ( $V_{BAT} < V_{SHORT}$ )																																							
4	T_120		R	Thermal regulation comparator, 1 when the die temperature is greater than 120°C. If battery is being charged in Precharge mode, the charge current is limited to 200 mA and in Fast Charge, 550 mA.																																							
3	ICHG		R	0 indicates the ICHARGE loop is controlling the battery charge current.																																							
2	IBUS		R	0 indicates the IBUS (input current) loop is controlling the battery charge current.																																							
1	VBUS_VALID		R	1 indicates $V_{BUS}$ has passed validation and is capable of charging.																																							
0	CV		R	1 indicates the constant-voltage loop (OREG) is controlling the charger and all current limiting loops have released.																																							
<b>MONITOR1</b> <span style="float: right;">Register Address: 11h (17)      Default Value=XX1X XXX0</span>																																											
7	GATE		R	The GATE bit indicates the state of the GATE pin. If the bit is "0", the pin is low, driving the PFET, Q5 on. A "1" will disable Q5, but current can still flow from battery to the system through Q5's body diode.																																							
6	VBAT		R	A "1" indicates $V_{BAT} > V_{BATMIN}$ in PP charging or $V_{BAT} > V_{LOWV}$ in PWM charging. A "0" indicates $V_{BAT} < V_{BATMIN}$ in PP charging or $V_{BAT} < V_{LOWV}$ in PWM charging.																																							
5	POK_B	1	R/W	POK_B indicates the state of the POK_B pin (see section on POK_B). This bit can be set to a 1 if VBAT has fallen below $V_{LOWV}$ , in turn the open drain POK_B pin will be Hi-Z.																																							
4	DIS_LEVEL		R	This pin indicates the state of the DIS pin. A "1" indicates the DIS pin is high and the device is in a Hi-Z state on the input and the PWM controller is not running.																																							
3	NOBAT		R	A "1" on this bit indicates that the device has determined there is no battery connected.																																							
2	PC_ON		R	A "1" on this bit indicates that Post charging (background charging) is in progress.																																							
1:0	Reserved	0	R	These bits always return 0.																																							

Bit	Name	Value	Type	Description
<b>NTC</b> <span style="float: right;"><b>Register Address: 12H (18)</b> <b>Default Value=000X XXXX</b></span>				
7:6	Reserved	00	R	These bits always return 0.
5	TEMP_DIS	0	R/W	NTC Temperature measurement results affect charge parameters.
		1		NTC Temperature measurement results do not affect charge. Temperature measurements continue to be updated every second in the NTC1-4 monitor bits.
4	NTC_OK		R	0 if NTC is either shorted to GND, open, or shorted to REF.
3	NTC4		R	1 indicates that NTC is above the T4 threshold.
2	NTC3		R	1 indicates that NTC is above the T3 threshold.
1	NTC2		R	1 indicates that NTC is above the T2 threshold.
0	NTC1		R	1 indicates that NTC is above the T1 threshold.
<b>WD_CONTROL</b> <span style="float: right;"><b>Register Address: 13h (19)</b> <b>Default Value = 0110 1110 (6Eh)</b></span>				
7	Reserved	0	R	This bit always returns 0
6	Reserved	1	R	This bit always returns 1
5	Reserved	1	R	This bit always returns 1
4	Reserved	0	R	This bit always returns 0
3	Reserved	1	R	This bit always returns 1
2	EN_VREG	1	R/W	The EN_VREG defaults to a "1" enabling the regulator. To disable the regulator, set the bit to a "0".
1	WD_DIS	1	R/W	A "1" disables the Watchdog ( $t_{32s}$ ) and $t_{15MIN}$ timers. Setting the bit to a "0" will enable the timers (See Safety Timer Section for further information).
0	Reserved	0	R	This bit always returns 0
<b>RESTART</b> <span style="float: right;"><b>Register Address: FAh (250)</b> <b>Default Value = 1111 1111 (FFh)</b></span>				
7:0	RESTART		W	Writing B5h restarts charging when the IC is in the charge done state. This register reads back FF.

## PCB Layout Recommendation

Bypass capacitors should be placed as close to the IC as possible. In particular, the total loop length for CMID should be minimized to reduce overshoot and ringing on the SW, PMID, and VBUS pins. Power and ground pins should be

routed directly to their bypass capacitors using the top copper layer. The copper area connecting to the IC should be maximized to improve thermal performance.

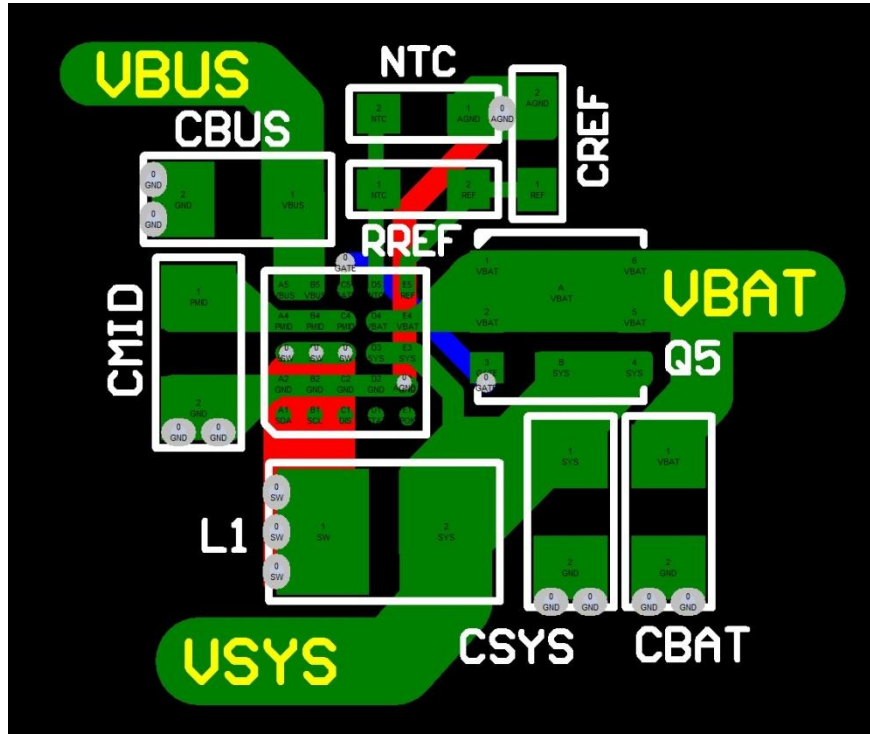
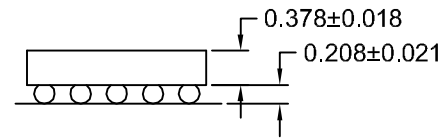
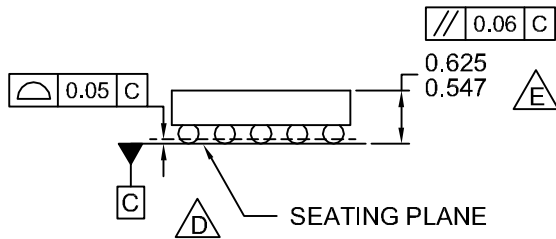
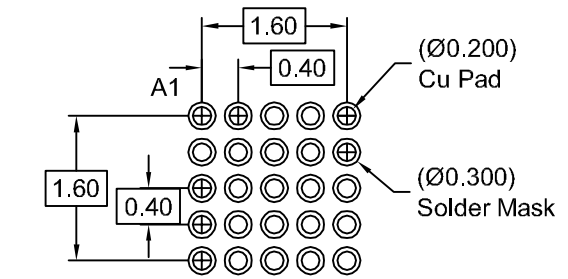
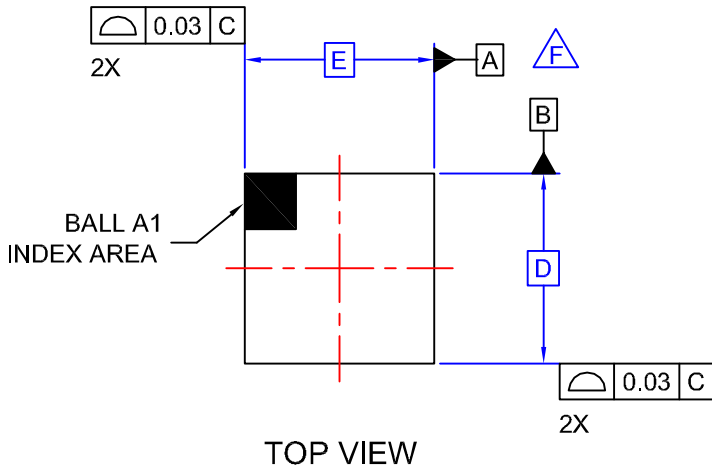

Figure 47. PCB Layout Recommendation

## Product-Specific Dimensions

Product	D	E	X	Y
FAN54053UCX	2.40 ±0.030	2.00 ±0.030	0.180	0.380



SIDE VIEWS

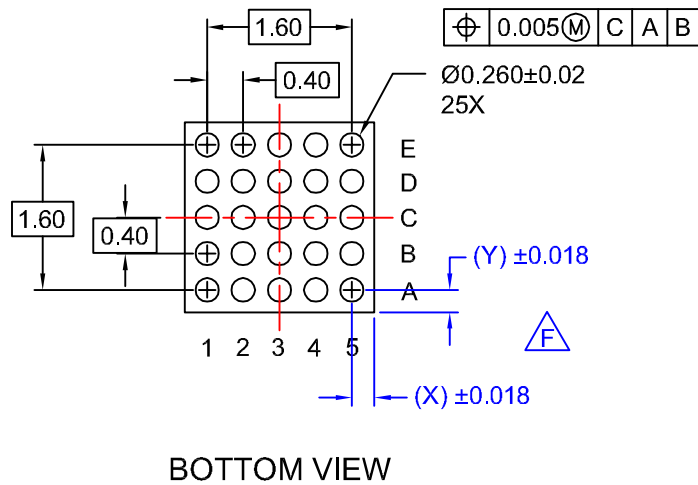

NOTES:

- A. NO JEDEC REGISTRATION APPLIES.
- B. DIMENSIONS ARE IN MILLIMETERS.
- C. DIMENSIONS AND TOLERANCE PER ASMEY14.5M, 1994.
- D. DATUM C IS DEFINED BY THE SPHERICAL CROWNS OF THE BALLS.
- E. PACKAGE NOMINAL HEIGHT IS 586 MICRONS ±39 MICRONS (547-625 MICRONS).
- F. FOR DIMENSIONS D, E, X, AND Y SEE PRODUCT DATASHEET.
- G. DRAWING FILNAME: MKT-UC025AArev2.





<b>APPROVALS</b>		<b>DATE</b>		 <b>25BALL WL-CSP, 5X5 ARRAY</b> <b>0.4MM PITCH, 250UM BALL</b>	
DRAWN L. England		2-16-10			
DFTG. CHK. S. Martin		3-1-10			
ENGR. CHK.					
 INCH [MM]		SCALE	SIZE	DRAWING NUMBER	REV
		N/A	N/A	MKT-UC025AA	2
DO NOT SCALE DRAWING				SHEET 1 of 1	





**TRADEMARKS**

The following includes registered and unregistered trademarks and service marks, owned by Fairchild Semiconductor and/or its global subsidiaries, and is not intended to be an exhaustive list of all such trademarks.

- |   |  |   |   |
|---|--|---|---|
| AccuPower™  | F-PFS™   | OPTOPLANAR®   |  |
| AttitudeEngine™   | FRFET®   |  | TinyBoost®  |
| Awinda®   | Global Power Resource™                         | PowerTrench®  | TinyBuck®   |
| AX-CAP®*  | GreenBridge™                                   | PowerXS™  | TinyCalc™   |
| BitSiC™   | Green FPS™                                     | Programmable Active Droop™  | TinyLogic®  |
| Build it Now™   | Green FPS™ e-Series™                           | QFET®   | TINYOPTO™   |
| CorePLUS™   | Gmax™  | QS™   | TinyPower™  |
| CorePOWER™  | GTO™   | Quiet Series™   | TinyPWM™  |
| CROSSVOLT™  | IntelliMAX™                                    | RapidConfigure™   | TinyWire™   |
| CTL™  | ISOPLANAR™                                     |  | TranSiC™  |
| Current Transfer Logic™   | Making Small Speakers Sound Louder and Better™ | Saving our world, 1mW/W/kW at a time™   | TriFault Detect™  |
| DEUXPEED®   | MegaBuck™                                      | SignalWise™   | TRUECURRENT®*   |
| Dual Cool™  | MICROCOUPLER™                                  | SmartMax™   | μSerDes™  |
| EcoSPARK®   | MicroFET™                                      | SMART START™  |  |
| EfficientMax™   | MicroPak™                                      | Solutions for Your Success™   | UHC®  |
| ESBC™   | MicroPak2™                                     | SPM®  | Ultra FRFET™  |
|  | MillerDrive™                                   | STEALTH™  | UniFET™   |
| Fairchild®  | MotionMax™                                     | SuperFET®   | VCX™  |
| Fairchild Semiconductor®  | MotionGrid®                                    | SuperSOT™-3   | VisualMax™  |
| FACT Quiet Series™  | MTI®   | SuperSOT™-6   | VoltagePlus™  |
| FACT®   | MTX®   | SuperSOT™-8   | XS™   |
| FAST®   | MVN®   | SupreMOS®   | Xsens™  |
| FastvCore™  | mWSaver®                                       | SyncFET™  | 仙童™   |
| FETBench™   | OptoHiT™                                       | Sync-Lock™  |   |
| FPS™  | OPTOLOGIC®                                     |   |   |

\* Trademarks of System General Corporation, used under license by Fairchild Semiconductor.

**DISCLAIMER**

FAIRCHILD SEMICONDUCTOR RESERVES THE RIGHT TO MAKE CHANGES WITHOUT FURTHER NOTICE TO ANY PRODUCTS HEREIN TO IMPROVE RELIABILITY, FUNCTION, OR DESIGN. TO OBTAIN THE LATEST, MOST UP-TO-DATE DATASHEET AND PRODUCT INFORMATION, VISIT OUR WEBSITE AT [HTTP://WWW.FAIRCHILDSEMI.COM](http://www.fairchildsemi.com). FAIRCHILD DOES NOT ASSUME ANY LIABILITY ARISING OUT OF THE APPLICATION OR USE OF ANY PRODUCT OR CIRCUIT DESCRIBED HEREIN; NEITHER DOES IT CONVEY ANY LICENSE UNDER ITS PATENT RIGHTS, NOR THE RIGHTS OF OTHERS. THESE SPECIFICATIONS DO NOT EXPAND THE TERMS OF FAIRCHILD'S WORLDWIDE TERMS AND CONDITIONS, SPECIFICALLY THE WARRANTY THEREIN, WHICH COVERS THESE PRODUCTS.

**LIFE SUPPORT POLICY**

FAIRCHILD'S PRODUCTS ARE NOT AUTHORIZED FOR USE AS CRITICAL COMPONENTS IN LIFE SUPPORT DEVICES OR SYSTEMS WITHOUT THE EXPRESS WRITTEN APPROVAL OF FAIRCHILD SEMICONDUCTOR CORPORATION.

As used herein:

1. Life support devices or systems are devices or systems which, (a) are intended for surgical implant into the body or (b) support or sustain life, and (c) whose failure to perform when properly used in accordance with instructions for use provided in the labeling, can be reasonably expected to result in a significant injury of the user.
2. A critical component in any component of a life support, device, or system whose failure to perform can be reasonably expected to cause the failure of the life support device or system, or to affect its safety or effectiveness.

**ANTI-COUNTERFEITING POLICY**

Fairchild Semiconductor Corporation's Anti-Counterfeiting Policy. Fairchild's Anti-Counterfeiting Policy is also stated on our external website, [www.fairchildsemi.com](http://www.fairchildsemi.com), under Sales Support.

Counterfeiting of semiconductor parts is a growing problem in the industry. All manufacturers of semiconductor products are experiencing counterfeiting of their parts. Customers who inadvertently purchase counterfeit parts experience many problems such as loss of brand reputation, substandard performance, failed applications, and increased cost of production and manufacturing delays. Fairchild is taking strong measures to protect ourselves and our customers from the proliferation of counterfeit parts. Fairchild strongly encourages customers to purchase Fairchild parts either directly from Fairchild or from Authorized Fairchild Distributors who are listed by country on our web page cited above. Products customers buy either from Fairchild directly or from Authorized Fairchild Distributors are genuine parts, have full traceability, meet Fairchild's quality standards for handling and storage and provide access to Fairchild's full range of up-to-date technical and product information. Fairchild and our Authorized Distributors will stand behind all warranties and will appropriately address any warranty issues that may arise. Fairchild will not provide any warranty coverage or other assistance for parts bought from Unauthorized Sources. Fairchild is committed to combat this global problem and encourage our customers to do their part in stopping this practice by buying direct or from authorized distributors.

**PRODUCT STATUS DEFINITIONS**

**Definition of Terms**

Datasheet Identification	Product Status	Definition
Advance Information	Formative / In Design	Datasheet contains the design specifications for product development. Specifications may change in any manner without notice.
Preliminary	First Production	Datasheet contains preliminary data; supplementary data will be published at a later date. Fairchild Semiconductor reserves the right to make changes at any time without notice to improve design.
No Identification Needed	Full Production	Datasheet contains final specifications. Fairchild Semiconductor reserves the right to make changes at any time without notice to improve the design.
Obsolete	Not In Production	Datasheet contains specifications on a product that is discontinued by Fairchild Semiconductor. The datasheet is for reference information only.

Rev. I73