



FSA8028

Audio Jack Detection and Configuration Switch

Features

Detection	Accessory Plug-In 3- or 4-Pole Audio Jack Send/End Key Pressed
Functionality	Decreased Timing for Sensitive Send/End Keys
Switch Type	MIC
V _{DD}	2.5 to 4.4 V
V _{IO}	1.6 to V _{DD}
THD (MIC)	0.01% Typical
ESD (Air Gap)	15 kV
Operating Temperature	-40°C to 85°C

Description

The FSA8028 is an audio jack detector and switch for 3- or 4-pole accessories. In addition to detection, the FSA8028 features an integrated MIC switch that allows the processor to configure the audio jack. The architecture is designed to allow common third-party headphones to be used for listening to music from mobile handsets, personal media players, and portable peripheral devices.

- Determines 3- or 4-Pole Audio Jacks
- Removes Audio Jack Pop-n-Click Caused by MIC Bias
- Detects Audio Jack Accessories:
 - Standard Headphones
 - Headsets with MIC
 - Send / End Button Presses
- Integrates a MIC Switch for 4-Pole Configuration

Applications

- 3.5 mm and 2.5 mm Audio Jacks
- Cellular Phones, Smart Phones
- MP3 and PMP

Ordering Information

Part Number	Operating Temperature Range	Top Mark	Package
FSA8028UMX	-40 to +85°C	KZ	10-Lead, 1.4 x 1.8 x 0.55 mm, 0.4 mm Pitch, Ultrathin Molded Leadless Package (UMLP)

Typical Application

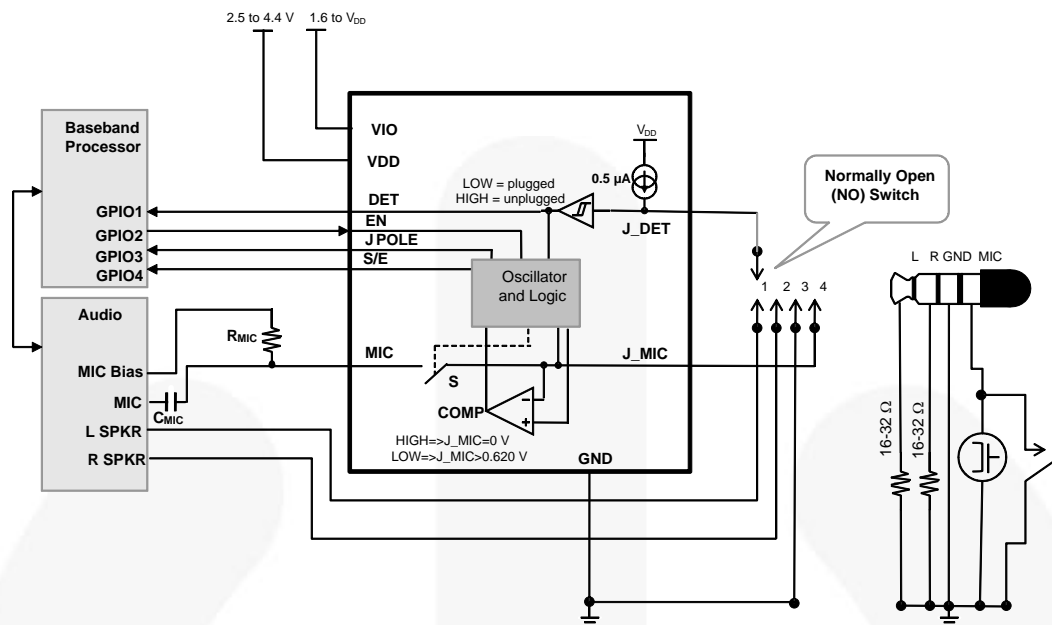

Figure 1. Mobile Phone Example

Pin Configuration

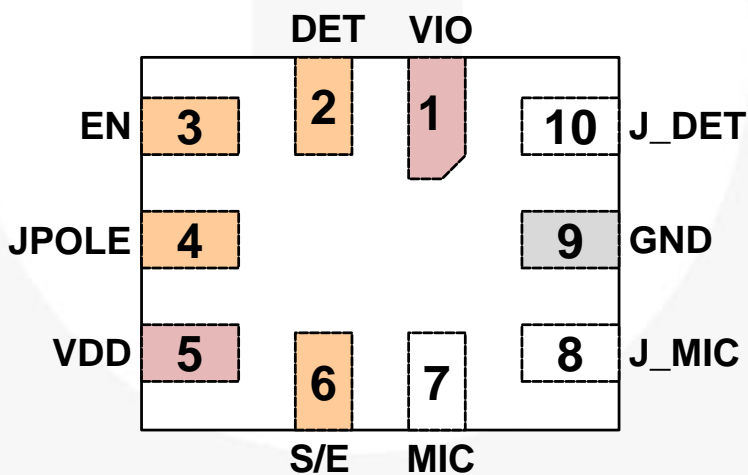

Figure 2. 10-Lead UMLP Pin Assignment (Through View)

Pin Descriptions

Name	Pin #	Type	Description	Function	
DET	2	Output	Indicates if an accessory is plugged into the audio jack, as detected on the J_DET pin	0	Plugged
				1	Unplugged
JPOLE	4	Output	Indicates if an accessory plugged into the audio jack is 3 pole or 4 pole	0	4-pole jack
				1	3-pole jack
S/E	6	Output	Indicates state of SEND/END for a 4-pole accessory when a key has been pressed	0	No key press
				1	Key press
EN	3	Input	Controls internal microphone switch between the J_MIC and MIC pins	0	MIC / J_MIC switch open
				1	MIC / J_MIC switch closed
J_DET	10	Input	Input from a pin of the audio jack socket tied to a mechanical switch that typically closes whenever an audio jack is inserted into that socket	0	Plugged
				1	Unplugged
MIC	7	Switch	Microphone switch path that goes to the microphone preamplifier	See EN pin	
J_MIC	8	Switch	Microphone switch path that connects to the microphone and SEND/END key audio jack pole		
VDD	5	Power	Core supply voltage		
VIO	1	Power	Baseband I/O supply voltage		
GND	9	Ground	Ground for both the audio jack and the PCB		

Note:

1. 0 = V_{OL} or V_{IL} ; 1 = V_{OH} or V_{IH}

Functional Diagram

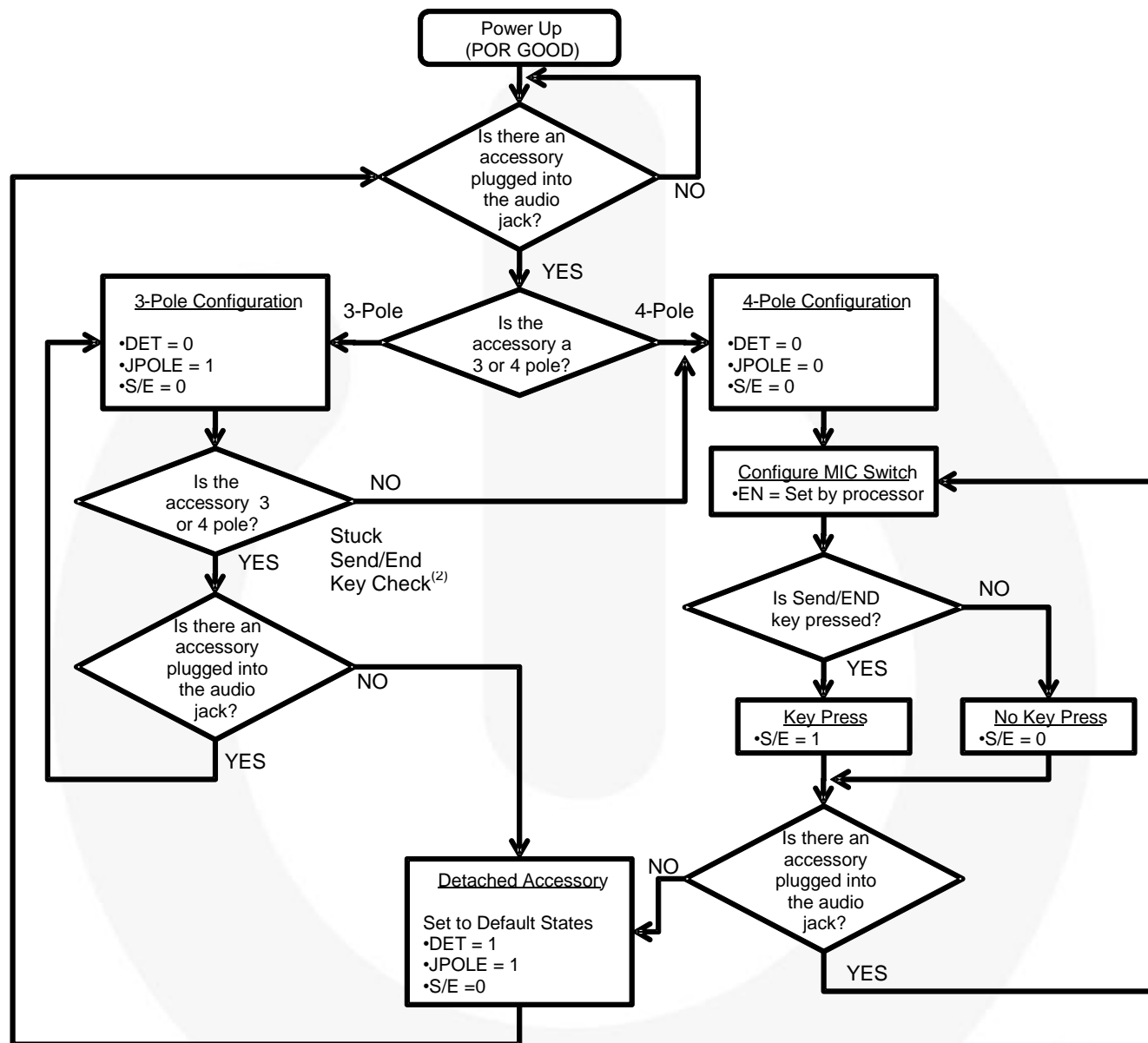

Figure 3. Functional Flow Diagram

Note:

2. Stuck Send/End key function is only available if EN=HIGH.

Table 1. FSA8028 Stuck Send/End Key

EN	FSA8028
HIGH	Stuck Send / End Key Active
LOW	Stuck Send / End Key Disabled

Table 2. States During Power Good and OFF

State Description	VDD	VIO	DET	EN	JPOLE	S/E	J-DET	MIC Switch
Active	1	1	Active					
OFF	0	0	1 (unplugged)	3-State	1 (3 Pole)	0 (No Press)	HIGH (unplugged)	Open
	1	0						
	0	1						

Table 3. FSA8028 I/O States During Detection⁽³⁾

J_DET	J_MIC	EN	S/E		JPOLE		DET
			3 Pole	4 Pole	3 Pole	4 Pole	
0	1	1	0 (no press)	0 (no press)	0 (4 Pole)	0 (4 Pole)	0
0	0	0	0 (no press)	1 (press)	1 (3 Pole)	0 (4 Pole)	0
0	1	0	0 (no press)	0 (no press)	1 (3 Pole)	0 (4 Pole)	0
0	0	1	0 (no press)	1 (press)	1 (3 Pole)	0 (4 Pole)	0
1	X	X	0 (no press)	0 (no press)	1 (3 Pole)	1 (3 Pole)	1

Note:

- State detected after initial plug-in.

Absolute Maximum Ratings

Stresses exceeding the absolute maximum ratings may damage the device. The device may not function or be operable above the recommended operating conditions and stressing the parts to these levels is not recommended. In addition, extended exposure to stresses above the recommended operating conditions may affect device reliability. The absolute maximum ratings are stress ratings only.

Symbol	Parameter	Min.	Max.	Units	
V_{DD} & V_{IO}	Supply Voltage from Battery	-0.5	6.0	V	
V_{SW}	Switch I/O Voltage for "S" Switch and All Input Voltages Except J_DET	-0.5	$V_{DD}+0.5$	V	
V_{JD}	Input Voltage for J_DET Input	-1.5	$V_{DD}+0.5$	V	
I_{IK}	Input Clamp Diode Current	-50		mA	
I_{SW}	Switch I/O Current (Continuous)		50	mA	
T_{STG}	Storage Temperature Range	-65	+150	°C	
T_J	Maximum Junction Temperature		+150	°C	
T_L	Lead Temperature (Soldering, 10 Seconds)		+260	°C	
ESD	IEC 61000-4-2 System ESD	Air Gap	15.0		kV
		Contact	8.0		
	JEDEC JESD22-A114, Human Body Model	All Pins	7.5		
		J_DET, J_MIC, V_{DD} , V_{IO}	12.0		
	JEDEC JESD22-C101, Charged Device Model	All Pins	2.0		

Note:

- The input and output negative ratings may be exceeded if the input and output diode current ratings are observed.

Recommended Operating Conditions

The Recommended Operating Conditions table defines the conditions for actual device operation. Recommended operating conditions are specified to ensure optimal performance to the datasheet specifications. Fairchild does not recommend exceeding them or designing to Absolute Maximum Ratings.

Symbol	Parameter	Min.	Max.	Units
V_{DD}	Battery Supply Voltage	2.5	4.4	V
V_{IO}	Parallel I/O Supply Voltage	1.6	V_{DD}	V
T_A	Operating Temperature	-40	+85	°C

DC Electrical Characteristics

All typical values are at $T_A=25^\circ\text{C}$ unless otherwise specified.

Symbol	Parameter	V_{DD} (V)	Conditions	$T_A = -40$ to $+85^\circ\text{C}$			Units
				Min.	Typ.	Max.	
MIC Switch							
R_{ON}	MIC Switch On Resistance	2.5	$I_{OUT} = 30\text{ mA}$, $V_{IN} = 2.0\text{ V}$		0.9	2.9	Ω
		2.8			0.8	2.5	
		3.8			0.6	2.0	
$R_{FLAT(ON)}$	On Resistance Flatness	2.5	$I_{OUT} = 30\text{ mA}$, $V_{IN} = 1.6, 2.0, 2.5\text{ V}$		1.50		Ω
		2.8	$I_{OUT} = 30\text{ mA}$, $V_{IN} = 1.6, 2.0, 2.8\text{ V}$		0.70		
		3.8	$I_{OUT} = 30\text{ mA}$, $V_{IN} = 1.6, 2.0, 2.8\text{ V}$		0.25		
V_{IN}	Switch Input Voltage Range	2.5 to 4.4		0		V_{DD}	V
C_{ON}	MIC and J_MIC Switch ON Capacitance	3.8	$f = 1\text{ MHz}$		76		pF
C_{OFF}	MIC and J_MIC Switch OFF Capacitance	3.8	$f = 1\text{ MHz}$		24		pF
J_DET							
J_DET_{AudioV}	Audio Voltage Range on J_DET Pin	2.5 to 4.4	DET = LOW	-1		1	V
J_DET_{Audiof}	Audio Frequency on J_DET Pin	2.5 to 4.4	DET = LOW	20		20000	Hz
J_DET_{RGND}	Detection Resistance to Ground	2.5 to 4.4	Audio Jack Inserted	0		500	K Ω
J_DET_{HYS}	Hysteresis of J_DET				230		mV
Parallel I/O							
V_{IH}	Input High Voltage			$0.7 \times V_{IO}$		V_{IO}	V
V_{IL}	Input Low Voltage					$0.3 \times V_{IO}$	V
V_{OH}	Output High Voltage		$I_{OH} = -100\ \mu\text{A}$	$0.8 \times V_{IO}$			V
V_{OL}	Output Low Voltage		$I_{OL} = +100\ \mu\text{A}$			$0.2 \times V_{IO}$	V
Comparator							
V_{COMP}	Comparator Threshold for SEND/END Sensing	2.5-3.8	J_DET, EN = LOW		620		mV
Current							
I_{OFF}	Power Off Leakage Current Through Switch	0	MIC and J_MIC Ports $V_{IN} = 4.4\text{ V}$			1.5	μA
I_{IN}	Input Leakage Current	0 to 4.4	Inputs 0 = 4.4 V			1	μA
$I_{CC-SLNA}$	Battery Supply Sleep Mode Current No Accessory Attached	2.5 to 4.4	Static Current During Sleep Mode (EN = LOW)		1	3	μA
$I_{CC-SLWA}$	Battery Supply Sleep Mode Current with Accessory Attached	2.5 to 4.4	Active Current (EN = LOW and/or DET = HIGH)		15	25	μA

AC Electrical Characteristics

All typical values are for $V_{CC}=3.3$ V at $T_A=25^\circ\text{C}$ unless otherwise specified.

Symbol	Parameter	V_{DD} (V)	Conditions	$T_A = -40$ to $+85^\circ\text{C}$			Unit
				Min.	Typ.	Max.	
MIC Switch							
THD	Total Harmonic Distortion	3.8	$R_T = 600 \Omega$, $V_{SW} = 0.5 V_{PP}$, $f = 20$ Hz to 20 kHz, $V_{IN} = 2.0$ V		0.01		%
O_{IRR}	Off Isolation	3.8	$f = 20$ kHz, $R_S = 32 \Omega$, $C_L = 0$ pF, $R_T = 32 \Omega$		-90		dB
Parallel I/O							
t_R, t_F	Output Edge Rates (DET, S/E, JPOLE)	2.5	$C_L = 5$ pF, 20% to 80%		19		ns
		3.8			15		
t_{POLL}	On Time of MIC Switch for Sensing SEND/END Button Press Oscillator Stable Time	2.5 to 4.4			1		ms
t_{PER}	Period of MIC Switching Time for Sensing SEND/END Button Press	2.5 to 4.4			10		ms
t_{DET-IN}	Debounce Time after J-DET Changes State from High to Low	2.5 to 4.4			422		ms
$t_{DET-REM}$	Debounce Time after J_DET Changes State from Low to High	2.5 to 4.4			30		μs
t_{DET}	Detection Timeout for Sensing 3-Pole or 4-Pole Audio Jack Plugged In	2.5 to 4.4			4.5		ms
t_{KBK}	Debounce Time for Sensing SEND/END Key Press / Release	2.5 to 4.4			27		ms
Power							
PSRR	Power Supply Rejection Ratio	3.8	Power Supply Noise 300 mV _{PP} , Measured 10/90%, $f = 217$ Hz		-90		dB

Table 4. Package Nominal Values

JEDEC Symbol	Description	Nominal Values (mm)
A	Overall Height	0.5
A1	Package Standoff	0.072
A3	Lead Thickness	0.152
b	Lead Width	0.4
L	Lead Length	0.2
e	Lead Pitch	0.4
D	Body Length (Y)	1.8
E	Body Width (X)	1.4

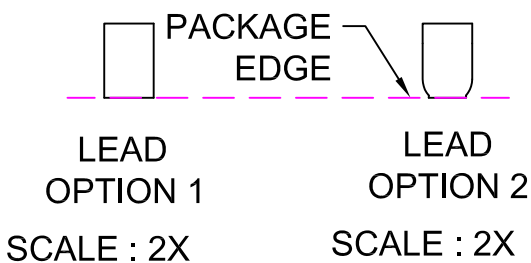
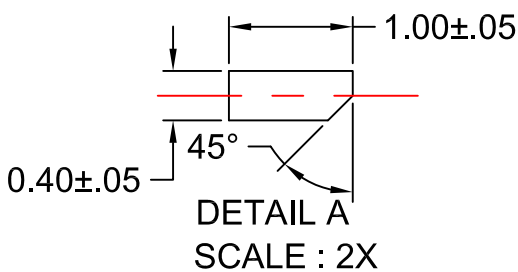
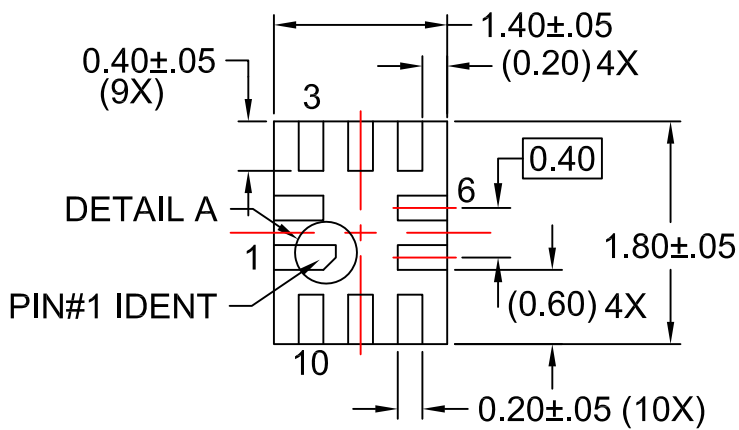
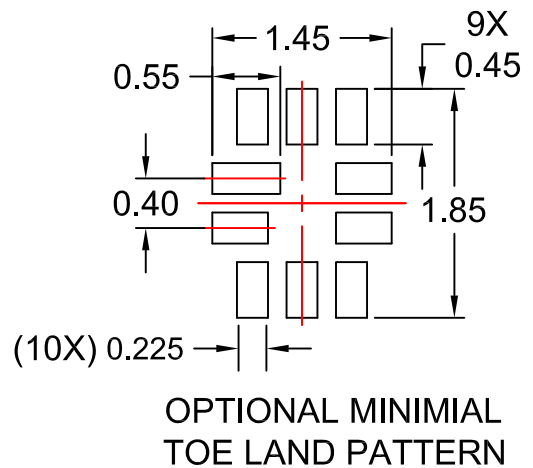
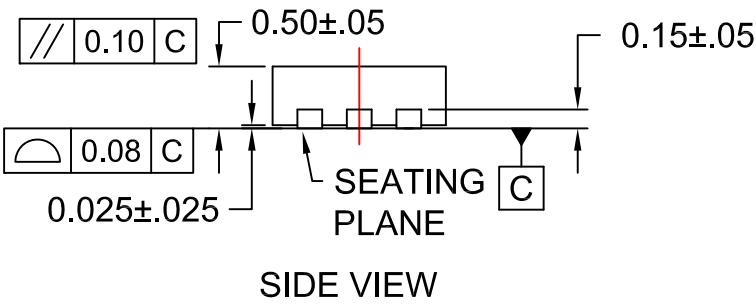
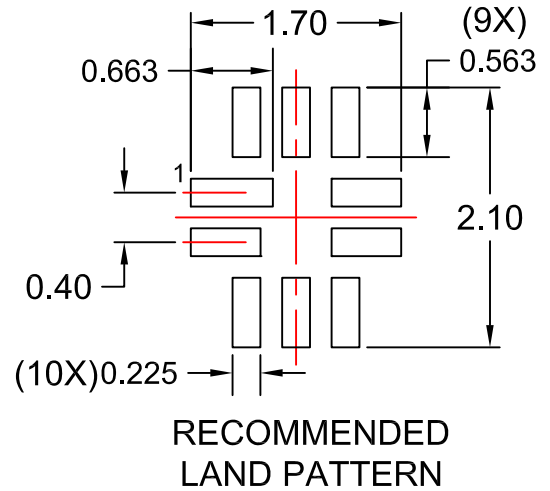
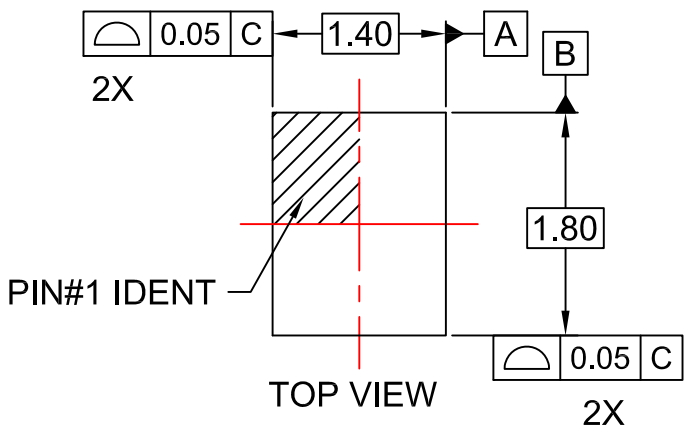

NOTES:

- A. PACKAGE DOES NOT CONFORM TO ANY JEDEC STANDARD.
- B. DIMENSIONS ARE IN MILLIMETERS.
- C. DIMENSIONS AND TOLERANCES PER ASME Y14.5M, 2009.
- D. LAND PATTERN RECOMMENDATION IS EXISTING INDUSTRY LAND PATTERN.
- E. DRAWING FILENAME: MKT-UMLP10Arev6.





TRADEMARKS

The following includes registered and unregistered trademarks and service marks, owned by Fairchild Semiconductor and/or its global subsidiaries, and is not intended to be an exhaustive list of all such trademarks.

- | | | | |
|--------------------------|--|---------------------------------------|------------------|
| AccuPower™ | F-PFS™ | OPTOPLANAR® | SYSTEM GENERAL® |
| AttitudeEngine™ | FRFET® | Power Supply WebDesigner™ | TinyBoost® |
| Awinda® | Global Power Resource SM | PowerTrench® | TinyBuck® |
| AX-CAP®* | GreenBridge™ | PowerXS™ | TinyCalc™ |
| BitSiC™ | Green FPS™ | Programmable Active Droop™ | TinyLogic® |
| Build it Now™ | Green FPS™ e-Series™ | QFET® | TINYOPTO™ |
| CorePLUS™ | Gmax™ | QS™ | TinyPower™ |
| CorePOWER™ | GTO™ | Quiet Series™ | TinyPWM™ |
| CROSSVOL™ | IntelliMAX™ | RapidConfigure™ | TinyWire™ |
| CTL™ | ISOPLANAR™ | Saving our world, 1mW/W/kW at a time™ | TranSiC™ |
| Current Transfer Logic™ | Making Small Speakers Sound Louder and Better™ | SignalWise™ | TriFault Detect™ |
| DEUXPEED® | MegaBuck™ | SmartMax™ | TRUECURRENT®* |
| Dual Cool™ | MICROCOUPLER™ | SMART START™ | μSerDes™ |
| EcoSPARK® | MicroFET™ | Solutions for Your Success™ | UHC® |
| EfficientMax™ | MicroPak™ | SPM® | Ultra FRFET™ |
| ESBC™ | MicroPak2™ | STEALTH™ | UniFET™ |
| F [®] | MillerDrive™ | SuperFET® | VCX™ |
| Fairchild® | MotionMax™ | SuperSOT™-3 | VisualMax™ |
| Fairchild Semiconductor® | MotionGrid® | SuperSOT™-6 | VoltagePlus™ |
| FACT Quiet Series™ | MTi® | SuperSOT™-8 | XST™ |
| FACT® | MTx® | SupreMOS® | Xsens™ |
| FastvCore™ | MVN® | SyncFET™ | 仙童® |
| FETBench™ | mWSaver® | Sync-Lock™ | |
| FPS™ | OptoHiT™ | | |
| | OPTOLOGIC® | | |

* Trademarks of System General Corporation, used under license by Fairchild Semiconductor.

DISCLAIMER

FAIRCHILD SEMICONDUCTOR RESERVES THE RIGHT TO MAKE CHANGES WITHOUT FURTHER NOTICE TO ANY PRODUCTS HEREIN TO IMPROVE RELIABILITY, FUNCTION, OR DESIGN. TO OBTAIN THE LATEST, MOST UP-TO-DATE DATASHEET AND PRODUCT INFORMATION, VISIT OUR WEBSITE AT [HTTP://WWW.FAIRCHILDSEMI.COM](http://www.fairchildsemi.com). FAIRCHILD DOES NOT ASSUME ANY LIABILITY ARISING OUT OF THE APPLICATION OR USE OF ANY PRODUCT OR CIRCUIT DESCRIBED HEREIN; NEITHER DOES IT CONVEY ANY LICENSE UNDER ITS PATENT RIGHTS, NOR THE RIGHTS OF OTHERS. THESE SPECIFICATIONS DO NOT EXPAND THE TERMS OF FAIRCHILD'S WORLDWIDE TERMS AND CONDITIONS, SPECIFICALLY THE WARRANTY THEREIN, WHICH COVERS THESE PRODUCTS.

AUTHORIZED USE

Unless otherwise specified in this data sheet, this product is a standard commercial product and is not intended for use in applications that require extraordinary levels of quality and reliability. This product may not be used in the following applications, unless specifically approved in writing by a Fairchild officer: (1) automotive or other transportation, (2) military/aerospace, (3) any safety critical application – including life critical medical equipment – where the failure of the Fairchild product reasonably would be expected to result in personal injury, death or property damage. Customer's use of this product is subject to agreement of this Authorized Use policy. In the event of an unauthorized use of Fairchild's product, Fairchild accepts no liability in the event of product failure. In other respects, this product shall be subject to Fairchild's Worldwide Terms and Conditions of Sale, unless a separate agreement has been signed by both Parties.

ANTI-COUNTERFEITING POLICY

Fairchild Semiconductor Corporation's Anti-Counterfeiting Policy. Fairchild's Anti-Counterfeiting Policy is also stated on our external website, www.fairchildsemi.com, under Terms of Use

Counterfeiting of semiconductor parts is a growing problem in the industry. All manufacturers of semiconductor products are experiencing counterfeiting of their parts. Customers who inadvertently purchase counterfeit parts experience many problems such as loss of brand reputation, substandard performance, failed applications, and increased cost of production and manufacturing delays. Fairchild is taking strong measures to protect ourselves and our customers from the proliferation of counterfeit parts. Fairchild strongly encourages customers to purchase Fairchild parts either directly from Fairchild or from Authorized Fairchild Distributors who are listed by country on our web page cited above. Products customers buy either from Fairchild directly or from Authorized Fairchild Distributors are genuine parts, have full traceability, meet Fairchild's quality standards for handling and storage and provide access to Fairchild's full range of up-to-date technical and product information. Fairchild and our Authorized Distributors will stand behind all warranties and will appropriately address any warranty issues that may arise. Fairchild will not provide any warranty coverage or other assistance for parts bought from Unauthorized Sources. Fairchild is committed to combat this global problem and encourage our customers to do their part in stopping this practice by buying direct or from authorized distributors.

PRODUCT STATUS DEFINITIONS

Definition of Terms

Datasheet Identification	Product Status	Definition
Advance Information	Formative / In Design	Datasheet contains the design specifications for product development. Specifications may change in any manner without notice.
Preliminary	First Production	Datasheet contains preliminary data; supplementary data will be published at a later date. Fairchild Semiconductor reserves the right to make changes at any time without notice to improve design.
No Identification Needed	Full Production	Datasheet contains final specifications. Fairchild Semiconductor reserves the right to make changes at any time without notice to improve the design.
Obsolete	Not In Production	Datasheet contains specifications on a product that is discontinued by Fairchild Semiconductor. The datasheet is for reference information only.

Rev. I77