

FSQ100

Green Mode Fairchild Power Switch (FPS™)

Features

- Internal Avalanche-Rugged SenseFET
- Precision Fixed Operating Frequency: 67KHz
- Burst-Mode Operation
- Internal Startup Circuit
- Pulse-by-Pulse Current Limiting
- Over-Voltage Protection (OVP)
- Overload Protection (OLP)
- Internal Thermal Shutdown Function (TSD)
- Auto-Restart Mode
- Under-Voltage Lockout (UVLO) with Hysteresis
- Built-in Soft-Start
- Secondary-Side Regulation

Applications

- Charger & Adapter for Mobile Phone, PDA, MP3
- Auxiliary Power for White Goods, PC, C-TV, Monitor

Related Application Notes

- [AN-4137 — Design Guidelines for Off-line Flyback Converters using FPS™](#)
- [AN-4141 — Troubleshooting and Design Tips for Fairchild Power Switch \(FPS™\) Flyback Applications](#)
- [AN-4147 — Design Guidelines for RCD Snubber of Flyback](#)
- [AN-4134 — Design Guidelines for Off-line Forward Converters using FPS™](#)
- [AN-4138 — Design Considerations for Battery Charger Using Green Mode Fairchild Power Switch \(FPS™\)](#)

Description

The FSQ100 consists of an integrated Pulse Width Modulator (PWM) and SenseFET, specifically designed for high-performance, off-line, Switch-Mode Power Supplies (SMPS) with minimal external components. This device is an integrated high-voltage power switching regulator that combines a VDMOS SenseFET with a voltage mode PWM control block. The integrated PWM controller features include a fixed oscillator, Under-Voltage Lockout (UVLO) protection, Leading Edge Blanking (LEB), an optimized gate turn-on/turn-off driver, Thermal Shutdown (TSD) protection, and temperature-compensated precision-current sources for loop compensation and fault protection circuitry.

When compared to a discrete MOSFET and controller or RCC solution, the FSQ100 device reduces total component count and design size and weight, while increasing efficiency, productivity, and system reliability. This device provides a basic platform well suited for cost-effective flyback converters.

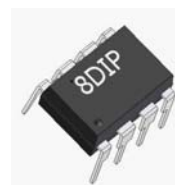

Ordering Information

Product Number	Package	Marking Code	BV _{DSS}	f _{osc}	R _{DS(ON)}
FSQ100	8-DIP	Q100	650V	67KHz	16Ω

FPS™ is a trademark of Fairchild Semiconductor Corporation.

Typical Application

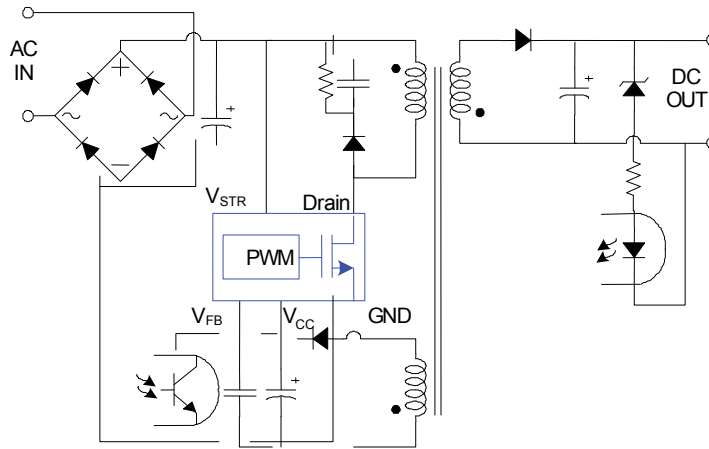

Figure 1. Typical Flyback Application

Table 1. Output Power Table

Product	Open Frame ⁽¹⁾	
	230V _{AC} ±15% ⁽²⁾	85~265V _{AC}
FSQ100	13W	8W

Notes:

1. Maximum practical continuous power in an open-frame design with sufficient drain pattern as a heat sinker, at 50°C ambient.
2. 230V_{AC} or 100/115V_{AC} with doubler.

Internal Block Diagram

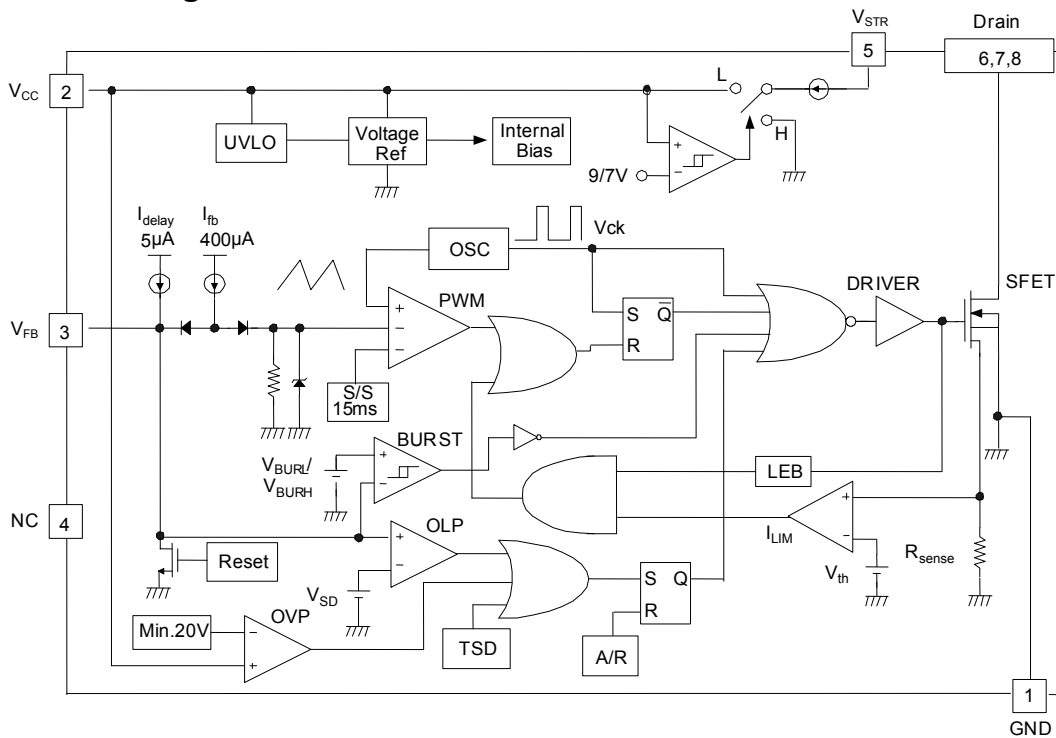

Figure 2. Functional Block Diagram

Pin Assignments

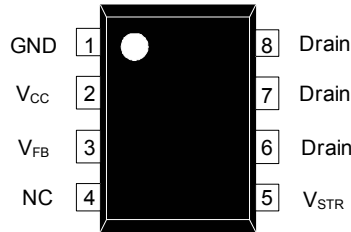

Figure 3. Pin Configuration (Top View)

Pin Definitions

Pin #	Name	Description
1	GND	Ground. SenseFET source terminal on primary-side and internal control ground.
2	V _{CC}	Positive Supply Voltage Input. Although connected to an auxiliary transformer winding, current is supplied from pin 5 (V _{STR}) via an internal switch during startup (see Figure 2). When V _{CC} reaches the UVLO upper threshold (9V), the internal startup switch opens and device power is supplied via the auxiliary transformer winding.
3	V _{FB}	Feedback. Inverting input to the PWM comparator with its normal input level lies between 0.5V and 2.5V. It has a 0.4mA current source connected internally, while a capacitor and optocoupler are typically connected externally. A feedback voltage of 4.5V triggers overload protection (OLP). There is a time delay while charging external capacitor C _{fb} from 3V to 4.5V using an internal 5μA current source. This time delay prevents false triggering under transient conditions, but still allows the protection mechanism to operate in true overload conditions.
4	NC	No Connection.
5	V _{STR}	Startup. This pin connects directly to the rectified AC line voltage source. At startup, the internal switch supplies internal bias and charges an external storage capacitor placed between the V _{CC} pin and ground. Once the V _{CC} reaches 9V, the internal switch stops charging the capacitor.
6,7,8	Drain	SenseFET Drain. The drain pins are designed to connect directly to the primary lead of the transformer and are capable of switching a maximum of 650V. Minimizing the length of the trace connecting these pins to the transformer decreases leakage inductance.

Absolute Maximum Ratings

Stresses exceeding the absolute maximum ratings may damage the device. The device may not function or be operable above the recommended operating conditions and stressing the parts to these levels is not recommended. In addition, extended exposure to stresses above the recommended operating conditions may affect device reliability. The absolute maximum ratings are stress ratings only. $T_A = 25^\circ\text{C}$, unless otherwise specified.

Symbol	Parameter	Value	Unit
V_{DRAIN}	Drain Pin Voltage	650	V
V_{STR}	VSTR Pin Voltage	650	V
V_{DG}	Drain-Gate Voltage	650	V
V_{GS}	Gate-Source Voltage	± 20	V
V_{CC}	Supply Voltage	20	V
V_{FB}	Feedback Voltage Range	-0.3 to V_{STOP}	V
P_{D}	Total Power Dissipation	1.40	W
T_{J}	Operating Junction Temperature	Internally limited	$^\circ\text{C}$
T_{A}	Operating Ambient Temperature	-25 to +85	$^\circ\text{C}$
T_{STG}	Storage Temperature	-55 to +150	$^\circ\text{C}$

Notes:

1. Repetitive rating: Pulse width is limited by maximum junction temperature.
2. $L = 24\text{mH}$, starting $T_{\text{J}} = 25^\circ\text{C}$.

Thermal Impedance

$T_A = 25^\circ\text{C}$, unless otherwise specified. All items are tested with the JEDEC standards JESD 51-2 and 51-10 (DIP).

Symbol	Parameter	Value	Unit
θ_{JA}	Junction-to-Ambient Thermal Impedance ⁽³⁾	88.84	$^\circ\text{C/W}$
θ_{JC}	Junction-to-Case Thermal Impedance ⁽⁴⁾	13.94	$^\circ\text{C/W}$

Notes:

3. Free-standing with no heatsink; without copper clad. Measurement condition; just before junction temperature T_{J} enters into OTP.
4. Measured on the DRAIN pin close to plastic interface.

Electrical Characteristics

$T_A = 25^\circ\text{C}$, unless otherwise specified.

Symbol	Parameter	Conditions	Min.	Typ.	Max.	Unit
SenseFET Section						
I_{DSS}	Zero-Gate-Voltage Drain Current	$V_{DS}=650\text{V}, V_{GS}=0\text{V}$			25	μA
		$V_{DS}=520\text{V}, V_{GS}=0\text{V}, T_C=125^\circ\text{C}$			200	
$R_{DS(ON)}$	Drain-Source On-State Resistance ⁽⁵⁾	$V_{GS}=10\text{V}, I_D=0.5\text{A}$		16	22	Ω
g_{fs}	Forward Trans-Conductance	$V_{DS}=50\text{V}, I_D=0.5\text{A}$	1.0	1.3		S
C_{ISS}	Input Capacitance	$V_{GS}=0\text{V}, V_{DS}=25\text{V}, f=1\text{MHz}$		162		pF
C_{OSS}	Output Capacitance			18		
C_{RSS}	Reverse Transfer Capacitance			3.8		
Control Section						
f_{OSC}	Switching Frequency		61	67	73	kHz
Δf_{OSC}	Switching Frequency Variation ⁽⁶⁾	$-25^\circ\text{C} \leq T_A \leq 85^\circ\text{C}$		± 5	± 10	%
D_{MAX}	Maximum Duty Cycle		60	67	74	%
V_{START}	UVLO Threshold Voltage	$V_{FB}=\text{GND}$	8	9	10	V
V_{STOP}		$V_{FB}=\text{GND}$	6	7	8	V
I_{FB}	Feedback Source Current	$0\text{V} \leq V_{FB} \leq 3\text{V}$	0.35	0.40	0.45	mA
$t_{S/S}$	Internal Soft Start Time		10	15	20	ms
Burst Mode Section						
V_{BURH}	Burst Mode Voltage	$T_J=25^\circ\text{C}$	0.6	0.7	0.8	V
V_{BURL}			0.45	0.55	0.65	V
$V_{BUR(HYS)}$		Hysteresis		150		mV
Protection Section						
I_{LIM}	Peak Current Limit		0.475	0.550	0.650	A
T_{SD}	Thermal Shutdown Temperature ⁽⁷⁾		125	145		$^\circ\text{C}$
V_{SD}	Shutdown Feedback Voltage		4.0	4.5	5.0	V
V_{OVP}	Over-Voltage Protection		20			V
I_{DELAY}	Shutdown Delay Current	$3\text{V} \leq V_{FB} \leq V_{SD}$	4	5	6	μA
Total Device Section						
I_{OP}	Operating Supply Current ⁽⁸⁾	$V_{CC} \leq 16\text{V}$		1.5	3.0	mA
I_{CH}	Startup Charging Current	$V_{CC}=0\text{V}, V_{STR}=50\text{V}$	450	550	650	μA

Notes:

- Pulse test: Pulse width $\leq 300\mu\text{s}$, duty $\leq 2\%$.
- These parameters, although guaranteed, are tested in EDS (wafer test) process.
- These parameters, although guaranteed, are not 100% tested in production.
- Control part only.

Typical Performance Characteristics

These characteristic graphs are normalized at $T_A = 25^\circ\text{C}$.

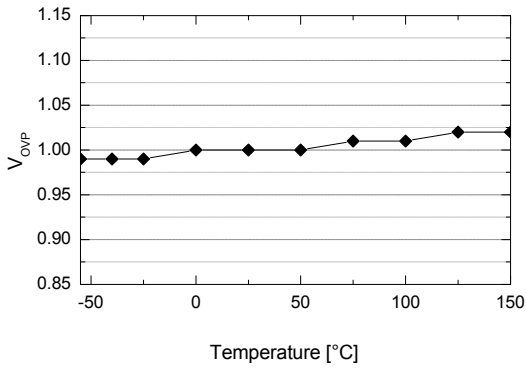

Figure 4. Over-Voltage Protection (V_{OVP}) vs. T_A

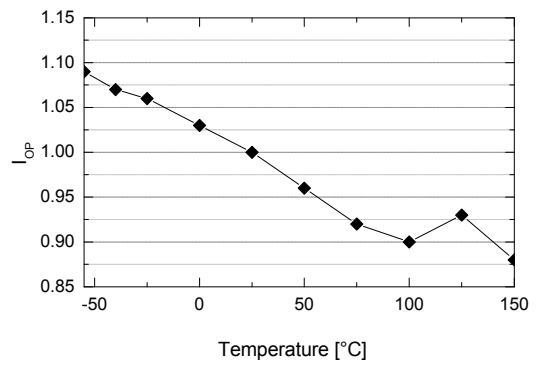

Figure 5. Operating Supply Current (I_{OP}) vs. T_A

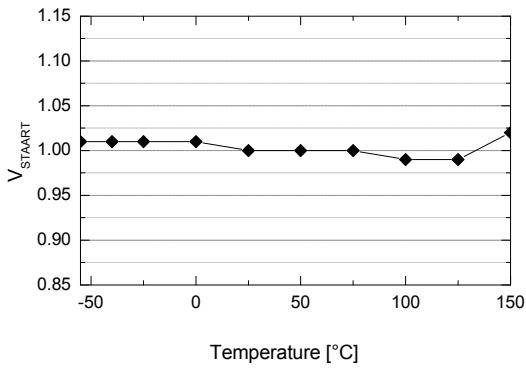

Figure 6. Start Threshold Voltage (V_{START}) vs. T_A

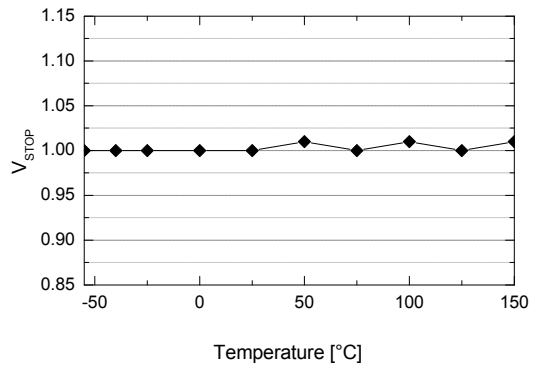

Figure 7. Stop Threshold Voltage (V_{STOP}) vs. T_A

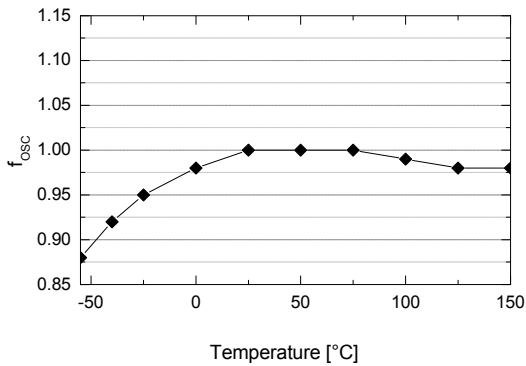

Figure 8. Operating Frequency (f_{OSC}) vs. T_A

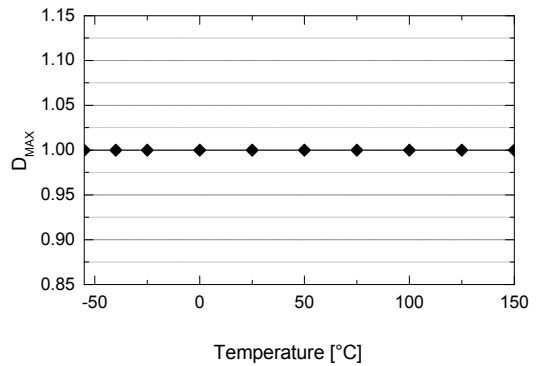

Figure 9. Maximum Duty Cycle (D_{MAX}) vs. T_A

Typical Performance Characteristics (Continued)

These characteristic graphs are normalized at $T_A = 25^\circ\text{C}$.

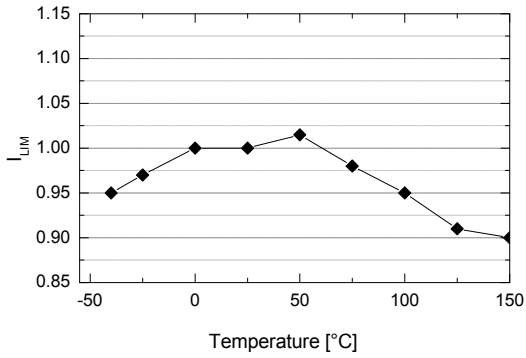

Figure 10. Peak Current Limit (I_{LIM}) vs. T_A

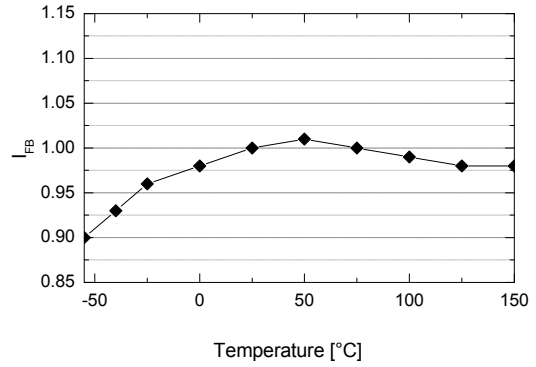

Figure 11. Feedback Source Current (I_{FB}) vs. T_A

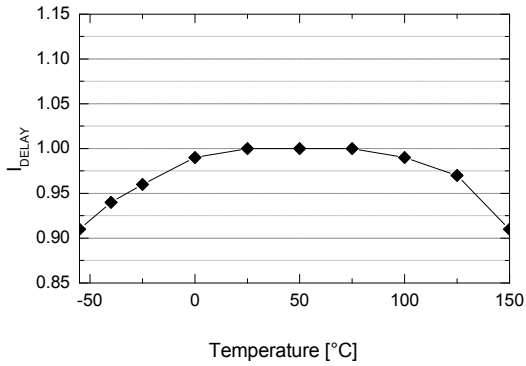

Figure 12. Shutdown Delay Current (I_{DELAY}) vs. T_A

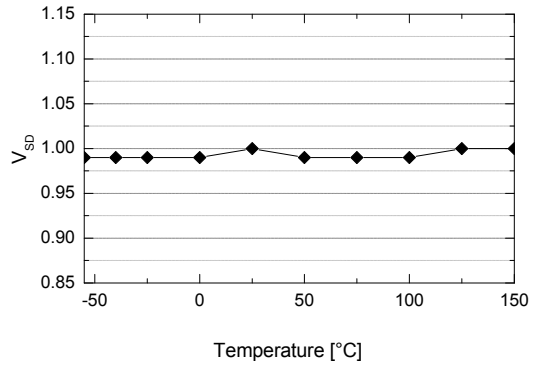

Figure 13. Shutdown Feedback Voltage (V_{SD}) vs. T_A

Functional Description

1. Startup: At startup, the internal high-voltage current source supplies the internal bias and charges the external V_{CC} capacitor, as shown in Figure 14. When V_{CC} reaches 9V, the device starts switching and the internal high-voltage current source stops charging the capacitor. The device is in normal operation provided V_{CC} does not drop below 7V. After startup, the bias is supplied from the auxiliary transformer winding.

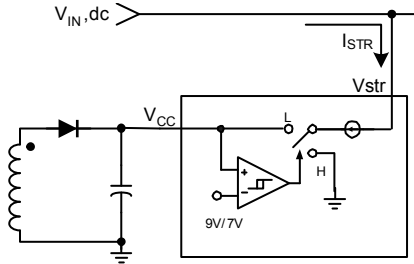

Figure 14. Internal Startup Circuit

Calculating the V_{CC} capacitor is an important step to design with the FSQ100. At initial startup, the maximum value of start operating current I_{START} is about $100\mu A$, which supplies current to UVLO and V_{REF} blocks. The charging current I_{VCC} of the V_{CC} capacitor is equal to $I_{STR} - 100\mu A$. After V_{CC} reaches the UVLO start voltage, only the bias winding supplies V_{CC} current to the device. When the bias winding voltage is not sufficient, the V_{CC} level decreases to the UVLO stop voltage and the internal current source is activated again to charge the V_{CC} capacitor. To prevent this V_{CC} fluctuation (charging/discharging), the V_{CC} capacitor should be chosen to have a value between $10\mu F$ and $47\mu F$.

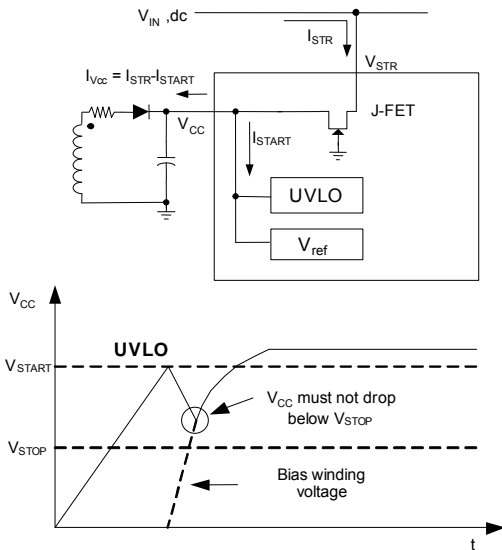

Figure 15. Charging V_{CC} Capacitor through V_{str}

2. Feedback Control: The FSQ100 is a voltage mode controlled device, as shown in Figure 16. Usually, an opto-coupler and shunt regulator, like KA431 are used to implement the feedback network. The feedback voltage is compared with an internally generated sawtooth waveform. This directly controls the duty cycle.

When the shunt regulator reference pin voltage exceeds the internal reference voltage of 2.5V, the opto-coupler LED current increases, the feedback voltage V_{FB} is pulled down, and it reduces the duty cycle. This happens when the input voltage increases or the output load decreases.

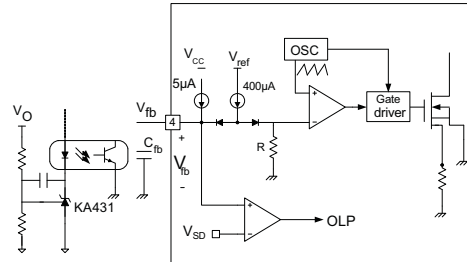

Figure 16. PWM and Feedback Circuit

3. Leading Edge Blanking (LEB): At the instant the internal SenseFET is turned on, the primary-side capacitance and secondary-side rectifier diode reverse recovery typically causes a high-current spike through the SenseFET. Excessive voltage across the R_{SENSE} resistor lead to incorrect pulse-by-pulse current limit protection. To avoid this, a leading edge blanking (LEB) circuit disables pulse-by-pulse current-limit protection block for a fixed time (t_{LEB}) after the SenseFET turns on.

4. Protection Circuit: The FSQ100 has protective functions, such as overload protection (OLP), over voltage protection (OVP), under-voltage lockout (UVLO), and thermal shutdown (TSD). Because these protection circuits are fully integrated inside the IC without external components, reliability is improved without increasing costs. Once a fault condition occurs, switching is terminated and the SenseFET remains off. This causes V_{CC} to fall. When V_{CC} reaches the UVLO stop voltage V_{STOP} (7V), the protection is reset and the internal high-voltage current source charges the V_{CC} capacitor via the V_{STR} pin. When V_{CC} reaches the UVLO start voltage V_{START} (9V), the device resumes normal operation. In this manner, the auto-restart can alternately enable and disable the switching of the power SenseFET until the fault condition is eliminated.

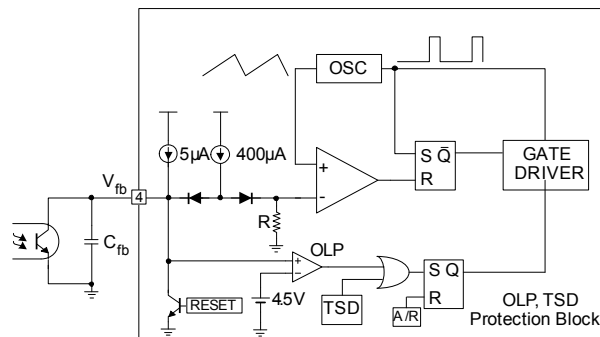

Figure 17. Protection Block

4.1 Overload Protection (OLP): Overload is defined as the load current exceeding a pre-set level due to an unexpected event. In this situation, the protection circuit should be activated to protect the SMPS. However, even when the SMPS is operating normally, the overload protection (OLP) circuit can be activated during the load transition. To avoid this undesired operation, the OLP circuit is designed to be activated after a specified time to determine whether it is a transient situation or a true overload situation. If the output consumes more than the maximum power determined by I_{LIM} , the output voltage (V_O) decreases below its rating voltage. This reduces the current through the opto-coupler LED, which also reduces the opto-coupler transistor current, thus increasing the feedback voltage (V_{FB}). If V_{FB} exceeds 3V, the feedback input diode is blocked and the $5\mu A$ current source (I_{DELAY}) starts to charge C_{FB} slowly up to V_{CC} . In this condition, V_{FB} increases until it reaches 4.5V, when the switching operation is terminated, as shown in Figure 18. The shutdown delay time is the time required to charge C_{FB} from 3V to 4.5V with a $5\mu A$ current source.

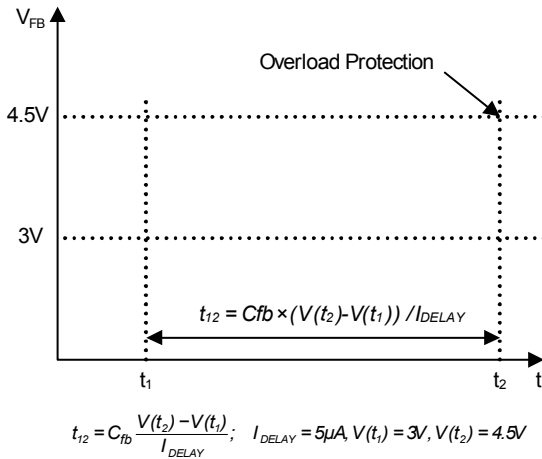

Figure 18. Overload Protection (OLP)

4.2 Thermal Shutdown (TSD): The SenseFET and the control IC are integrated, making it easier for the control IC to detect the temperature of the SenseFET. When the temperature exceeds approximately 145°C, thermal shutdown is activated.

5. Soft-Start: The FPS has an internal soft-start circuit that slowly increases the feedback voltage, together with the SenseFET current, right after it starts. The typical soft-start time is 15ms, as shown in Figure 19, where progressive increment of the SenseFET current is allowed during the startup phase. Soft-start circuit progressively increases current limits to establish proper working conditions for transformers, inductors, capacitors, and switching devices. It also helps to prevent transformer saturation and reduces the stress on the secondary diode.

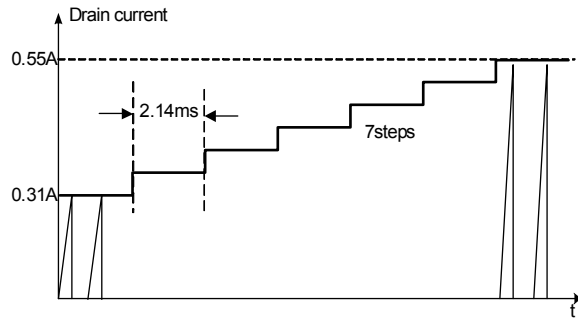

Figure 19. Internal Soft-Start

6. Burst Operation: To minimize the power dissipation in standby mode, the FSQ100 enters burst-mode operation. As the load decreases, the feedback voltage decreases. The device automatically enters burst mode when the feedback voltage drops below V_{BURL} (0.55V). At this point, switching stops and the output voltages start to drop. This causes the feedback voltage to rise. Once it passes V_{BURH} (0.70V), switching starts again. The feedback voltage falls and the process repeats. Burst-mode operation alternately enables and disables switching of the power MOSFET to reduce the switching loss in standby mode.

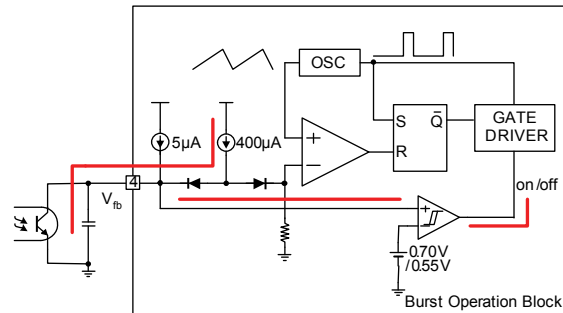

Figure 20. Burst Operation Block

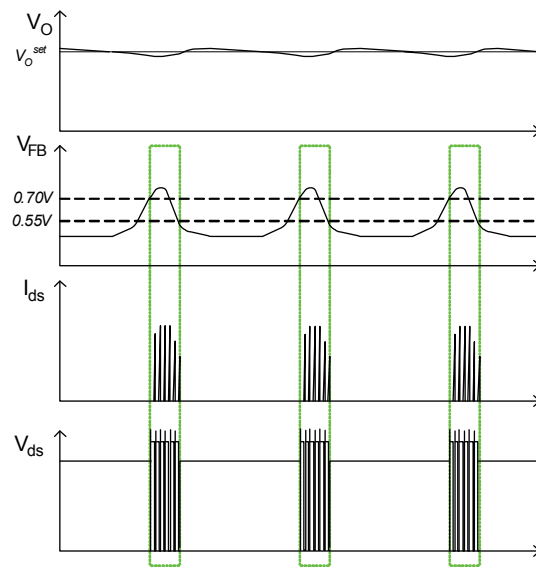
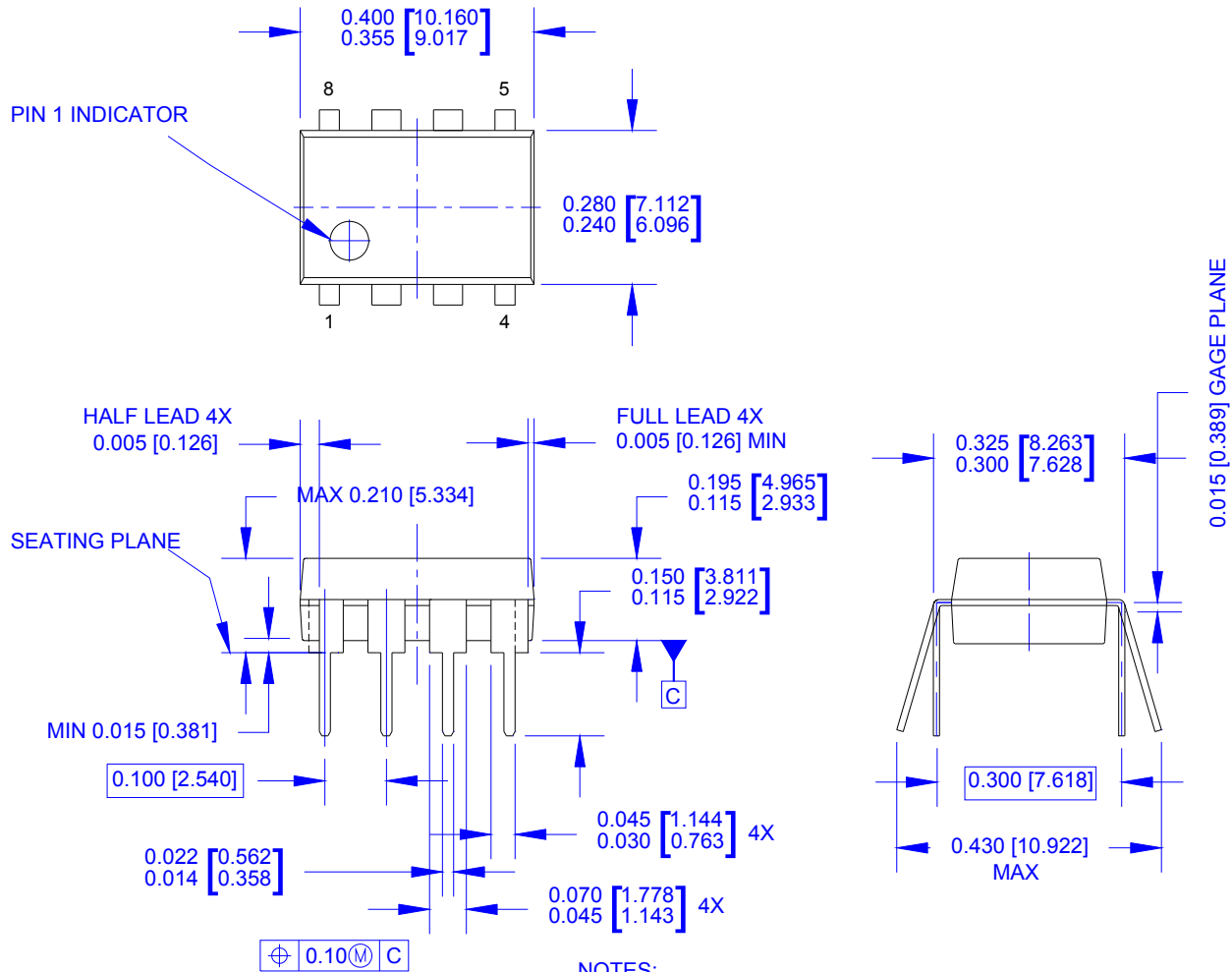

Figure 21. Burst Operation Function

Physical Dimensions



NOTES:







- A) THIS PACKAGE CONFORMS TO JEDEC MS-001 VARIATION BA
- B) CONTROLLING DIMS ARE IN INCHES
- C) DIMENSIONS ARE EXCLUSIVE OF BURRS, MOLD FLASH, AND TIE BAR EXTRUSIONS.
- D) DIMENSIONS AND TOLERANCES PER ASME Y14.5M-1982
- E) DRAWING FILENAME AND REVISION: MKT-N08MREV1.

Figure 24. 8-Pin Dual Inline Package (DIP)



TRADEMARKS

The following includes registered and unregistered trademarks and service marks, owned by Fairchild Semiconductor and/or its global subsidiaries, and is not intended to be an exhaustive list of all such trademarks.

- | | | | |
|---|---|---|---|
| AccuPower™ | F-PFS™ | Power-SPM™ | The Power Franchise® |
| Auto-SPM™ | FRFET® | PowerTrench® | The Right Technology for Your Success™ |
| AX-CAP™* | Global Power Resource™ | PowerXS™ |  |
| Build it Now™ | Green FPS™ | Programmable Active Droop™ | TinyBoost™ |
| CorePLUS™ | Green FPS™ e-Series™ | QFET® | TinyBuck™ |
| CorePOWER™ | Gmax™ | QS™ | TinyCalc™ |
| CROSSVOLT™ | GTO™ | Quiet Series™ | TinyLogic® |
| CTL™ | IntelliMAX™ | RapidConfigure™ | TINYOPTO™ |
| Current Transfer Logic™ | ISOPLANAR™ |  | TinyPower™ |
| DEUXPEED® | MegaBuck™ | Saving our world, 1mW/kW at a time™ | TinyPWM™ |
| Dual Cool™ | MICROCOUPLER™ | SignalWise™ | TinyWire™ |
| EcoSPARK® | MicroFET™ | SmartMax™ | TrnFault Detect™ |
| EfficientMax™ | MicroPak™ | SMART START™ | TRUECURRENT®* |
| ESBC™ | MicroPak2™ | SPM® | μSerDes™ |
|  | MillerDrive™ | STEALTH™ |  |
| Fairchild® | MotionMax™ | SuperFET® | UHC® |
| Fairchild Semiconductor® | Motion-SPM™ | SuperSOT™-3 | Ultra FRFET™ |
| FACT Quiet Series™ | mWSaver™ | SuperSOT™-6 | UniFET™ |
| FACT® | OptoHiT™ | SuperSOT™-8 | Vcx™ |
| FAST® | OPTOLOGIC® | SupreMOS® | VisualMax™ |
| FastvCore™ | OPTOPLANAR® | SynCFET™ | XST™ |
| FETBench™ |  | Syn-Lock™ | |
| FlashWriter®* | PDP SPM™ |  | |
| FPS™ | | | |

* Trademarks of System General Corporation, used under license by Fairchild Semiconductor.

DISCLAIMER

FAIRCHILD SEMICONDUCTOR RESERVES THE RIGHT TO MAKE CHANGES WITHOUT FURTHER NOTICE TO ANY PRODUCTS HEREIN TO IMPROVE RELIABILITY, FUNCTION, OR DESIGN. FAIRCHILD DOES NOT ASSUME ANY LIABILITY ARISING OUT OF THE APPLICATION OR USE OF ANY PRODUCT OR CIRCUIT DESCRIBED HEREIN; NEITHER DOES IT CONVEY ANY LICENSE UNDER ITS PATENT RIGHTS, NOR THE RIGHTS OF OTHERS. THESE SPECIFICATIONS DO NOT EXPAND THE TERMS OF FAIRCHILD'S WORLDWIDE TERMS AND CONDITIONS, SPECIFICALLY THE WARRANTY THEREIN, WHICH COVERS THESE PRODUCTS.

LIFE SUPPORT POLICY

FAIRCHILD'S PRODUCTS ARE NOT AUTHORIZED FOR USE AS CRITICAL COMPONENTS IN LIFE SUPPORT DEVICES OR SYSTEMS WITHOUT THE EXPRESS WRITTEN APPROVAL OF FAIRCHILD SEMICONDUCTOR CORPORATION.

As used herein:

1. Life support devices or systems are devices or systems which, (a) are intended for surgical implant into the body or (b) support or sustain life, and (c) whose failure to perform when properly used in accordance with instructions for use provided in the labeling, can be reasonably expected to result in a significant injury of the user.
2. A critical component in any component of a life support, device, or system whose failure to perform can be reasonably expected to cause the failure of the life support device or system, or to affect its safety or effectiveness.

ANTI-COUNTERFEITING POLICY

Fairchild Semiconductor Corporation's Anti-Counterfeiting Policy. Fairchild's Anti-Counterfeiting Policy is also stated on our external website, www.fairchildsemi.com, under Sales Support.

Counterfeiting of semiconductor parts is a growing problem in the industry. All manufacturers of semiconductor products are experiencing counterfeiting of their parts. Customers who inadvertently purchase counterfeit parts experience many problems such as loss of brand reputation, substandard performance, failed applications, and increased cost of production and manufacturing delays. Fairchild is taking strong measures to protect ourselves and our customers from the proliferation of counterfeit parts. Fairchild strongly encourages customers to purchase Fairchild parts either directly from Fairchild or from Authorized Fairchild Distributors who are listed by country on our web page cited above. Products customers buy either from Fairchild directly or from Authorized Fairchild Distributors are genuine parts, have full traceability, meet Fairchild's quality standards for handling and storage and provide access to Fairchild's full range of up-to-date technical and product information. Fairchild and our Authorized Distributors will stand behind all warranties and will appropriately address any warranty issues that may arise. Fairchild will not provide any warranty coverage or other assistance for parts bought from Unauthorized Sources. Fairchild is committed to combat this global problem and encourage our customers to do their part in stopping this practice by buying direct or from authorized distributors.

PRODUCT STATUS DEFINITIONS

Definition of Terms

Datasheet Identification	Product Status	Definition
Advance Information	Formative / In Design	Datasheet contains the design specifications for product development. Specifications may change in any manner without notice.
Preliminary	First Production	Datasheet contains preliminary data; supplementary data will be published at a later date. Fairchild Semiconductor reserves the right to make changes at any time without notice to improve design.
No Identification Needed	Full Production	Datasheet contains final specifications. Fairchild Semiconductor reserves the right to make changes at any time without notice to improve the design.
Obsolete	Not In Production	Datasheet contains specifications on a product that is discontinued by Fairchild Semiconductor. The datasheet is for reference information only.

Rev. 153