

# 6-Channel EMI Filter with Integrated ESD Protection

## NUF6401

The NUF6401MN is a six-channel (C–R–C) Pi-style EMI filter array with integrated ESD protection. Its typical component values of  $R = 100 \Omega$  and  $C = 17 \text{ pF}$  deliver a cutoff frequency of 110 MHz and stop band attenuation greater than  $-30 \text{ dB}$  from 800 MHz to 3.0 GHz.

This performance makes the part ideal for parallel interfaces with data rates up to 74 Mbps in applications where wireless interference must be minimized. The specified attenuation range is very effective in minimizing interference from 2G/3G, GPS, Bluetooth® and WLAN signals.

The NUF6401MN is available in low-profile 12-lead 1.35 mm x 3.0 mm DFN12/DFNW12 surface mount packages.

### Features/Benefits

- $\pm 15 \text{ kV}$  ESD Protection on each channel (IEC61000-4-2 Contact Discharge)
- R/C Values of  $100 \Omega$  and  $17 \text{ pF}$  deliver Exceptional S21 Performance Characteristics of 110 MHz  $f_{3\text{dB}}$  and  $-30 \text{ dB}$  Stop Band Attenuation from 800 MHz to 3.0 GHz
- Integrated EMI/ESD System Solution in DFN/DFNW Packages Offer Exceptional Cost, System Reliability and Space Savings
- SZNUF6401MNWT1G – Wettable Flank Package for optimal Automated Optical Inspection (AOI)
- S & SZ Prefix for Automotive and Other Applications Requiring Unique Site and Control Change Requirements; AEC-Q101 Qualified and PPAP Capable
- These Devices are Pb-Free, Halogen Free/BFR Free and are RoHS Compliant

### Applications

- EMI Filtering for LCD and Camera Data Lines
- EMI Filtering and Protection for I/O Ports and Keypads



ON Semiconductor®

[www.onsemi.com](http://www.onsemi.com)

### MARKING DIAGRAMS

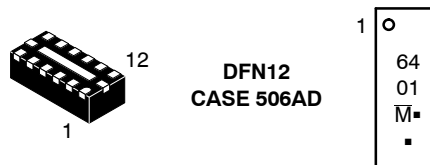

6401 = Specific Device Code

M = Month

▪ = Pb-Free Package

(Note: Microdot may be in either location)

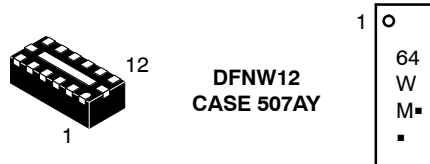

64W = Specific Device Code

M = Date Code

▪ = Pb-Free Package

(Note: Microdot may be in either location)

### ORDERING INFORMATION

Device	Package	Shipping†
NUF6401MNT1G	DFN12 (Pb-Free)	3000 / Tape & Reel
SNUF6401MNT1G	DFN12 (Pb-Free)	3000 / Tape & Reel
SZNUF6401MNWT1G	DFNW12 (Pb-Free)	3000 / Tape & Reel

†For information on tape and reel specifications, including part orientation and tape sizes, please refer to our Tape and Reel Packaging Specifications Brochure, BRD8011/D.

# NUF6401

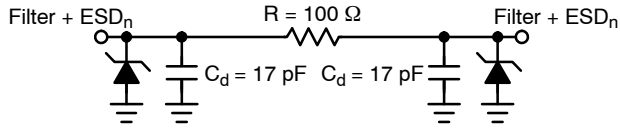

See Table 1 for pin description

Figure 1. Electrical Schematic

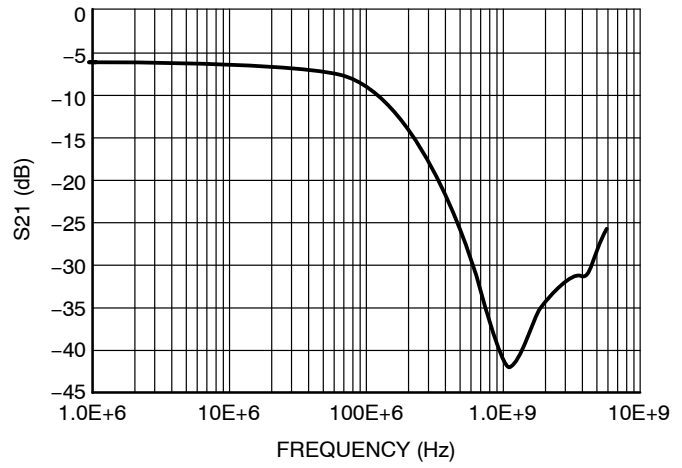

Figure 2. Typical Insertion Loss Characteristic

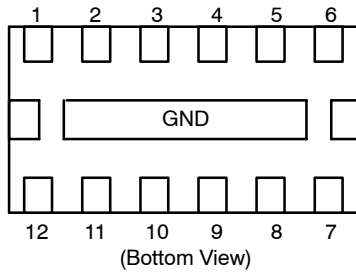

Figure 3. Pin Diagram

Table 1. FUNCTIONAL PIN DESCRIPTION

Filter	Device Pins	Description
Filter 1	1 & 12	Filter + ESD Channel 1
Filter 2	2 & 11	Filter + ESD Channel 2
Filter 3	3 & 10	Filter + ESD Channel 3
Filter 4	4 & 9	Filter + ESD Channel 4
Filter 5	5 & 8	Filter + ESD Channel 4
Filter 6	6 & 7	Filter + ESD Channel 4
Ground Pad	GND	Ground

# NUF6401

## MAXIMUM RATINGS

Parameter	Symbol	Value	Unit
ESD Discharge IEC61000-4-2 Contact Discharge	$V_{PP}$	15	kV
DC Power per Resistor	$P_R$	100	mW
DC Power per Package	$P_T$	600	mW
Operating Temperature Range	$T_{OP}$	-40 to 105	°C
Storage Temperature Range	$T_{STG}$	-55 to 150	°C
Maximum Lead Temperature for Soldering Purposes (1.8 in from case for 10 seconds)	$T_L$	260	°C

Stresses exceeding those listed in the Maximum Ratings table may damage the device. If any of these limits are exceeded, device functionality should not be assumed, damage may occur and reliability may be affected.

## ELECTRICAL CHARACTERISTICS ( $T_J = 25^\circ\text{C}$ unless otherwise noted)

Parameter	Symbol	Test Conditions	Min	Typ	Max	Unit
Maximum Reverse Working Voltage	$V_{RWM}$				5.0	V
Breakdown Voltage	$V_{BR}$	$I_R = 1.0 \text{ mA}$	6.0	7.0		V
Leakage Current	$I_R$	$V_{RWM} = 3.0 \text{ V}$ $V_{RWM} = 5.0 \text{ V}$		10 50	1000 1000	nA
Resistance	$R_A$	$I_R = 10 \text{ mA}$	85	100	115	$\Omega$
Diode Capacitance	$C_d$	$V_R = 2.5 \text{ V}, f = 1.0 \text{ MHz}$		17	20	pF
Line Capacitance	$C_L$	$V_R = 2.5 \text{ V}, f = 1.0 \text{ MHz}$		34	40	pF
3 dB Cut-Off Frequency (Note 1)	$f_{3dB}$	Above this frequency, appreciable attenuation occurs		110		MHz
6 dB Cut-Off Frequency (Note 1)	$f_{6dB}$	Above this frequency, appreciable attenuation occurs		175		MHz

1. 50  $\Omega$  source and 50  $\Omega$  load termination.

# NUF6401

## TYPICAL PERFORMANCE CURVES ( $T_A = 25^\circ\text{C}$ unless otherwise specified)

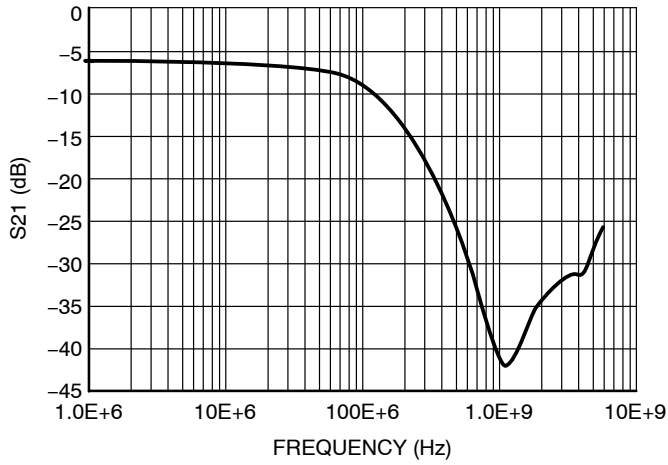

Figure 4. Typical Insertion Loss Characteristic

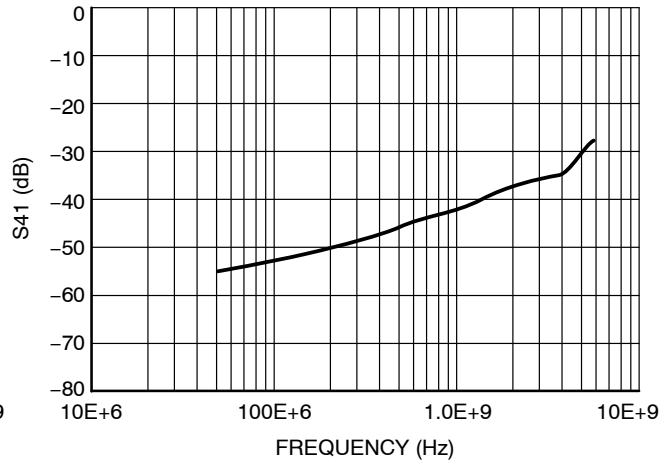

Figure 5. Typical Analog Crosstalk

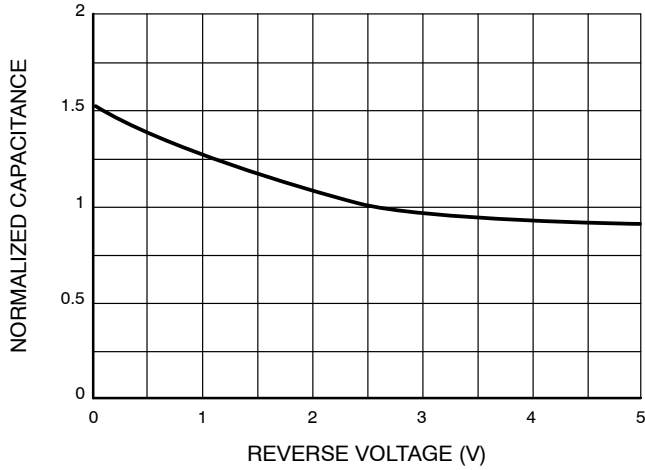

Figure 6. Typical Capacitance vs. Reverse Biased Voltage  
(Normalized Capacitance, Cd @ 2.5 V)

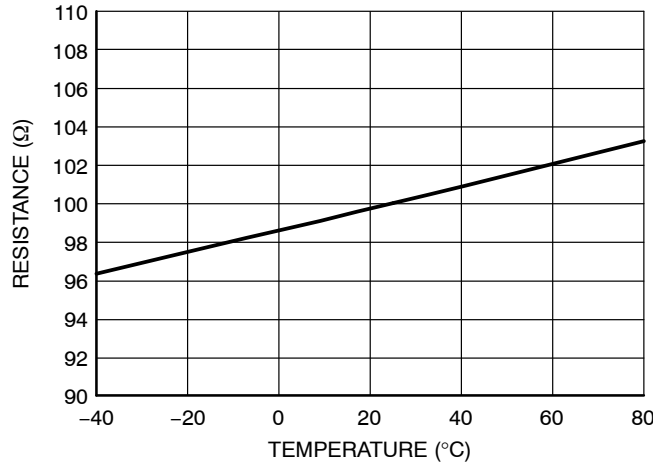

Figure 7. Typical Resistance over Temperature

**Theory of Operation**

The NUF6401MN combines ESD protection and EMI filtering conveniently into a small package for today’s size constrained applications. The capacitance inherent to a typical protection diode is utilized to provide the capacitance value necessary to create the desired frequency response based upon the series resistance in the filter. By combining this functionality into one device, a large number of discrete components are integrated into one small package saving valuable board space and reducing BOM count and cost in the application.

**Application Example**

The accepted practice for specifying bandwidth in a filter is to use the 3 dB cutoff frequency. Utilizing points such as the 6 dB or 9 dB cutoff frequencies results in signal degradation in an application. This can be illustrated in an application example. A typical application would include EMI filtering of data lines in a camera or display interface. In such an example it is important to first understand the signal and its spectral content. By understanding these things, an appropriate filter can be selected for the desired application. A typical data signal is pattern of 1’s and 0’s transmitted over a line in a form similar to a square wave. The maximum frequency of such a signal would be the pattern 1-0-1-0 such that for a signal with a data rate of 100 Mbps, the maximum frequency component would be 50 MHz. The next item to consider is the spectral content of the signal, which can be understood with the Fourier series

approximation of a square wave, shown below in Equations 1 and 2 in the Fourier series approximation.

From this it can be seen that a square wave consists of odd order harmonics and to fully construct a square wave n must go to infinity. However, to retain an acceptable portion of the waveform, the first two terms are generally sufficient. These two terms contain about 85% of the signal amplitude and allow a reasonable square wave to be reconstructed. Therefore, to reasonably pass a square wave of frequency x the minimum filter bandwidth necessary is 3x. All ON Semiconductor EMI filters are rated according to this principle. Attempting to violate this principle will result in significant rounding of the waveform and cause problems in transmitting the correct data. For example, take the filter with the response shown in Figure 8 and apply three different data waveforms. To calculate these three different frequencies, the 3 dB, 6 dB, and 9 dB bandwidths will be used.

**Equation 1:**

$$x(t) = \frac{1}{2} + \frac{2}{\pi} \sum_{n=1}^a \left[ \frac{1}{2n-1} \sin((2n-1)\omega_0 t) \right] \quad (\text{eq. 1})$$

**Equation 2 (simplified form of Equation 1):**

$$x(t) = \frac{1}{2} + \frac{2}{\pi} \left[ \frac{\sin(\omega_0 t)}{1} + \frac{\sin(3\omega_0 t)}{3} + \frac{\sin(5\omega_0 t)}{5} + \dots \right] \quad (\text{eq. 2})$$

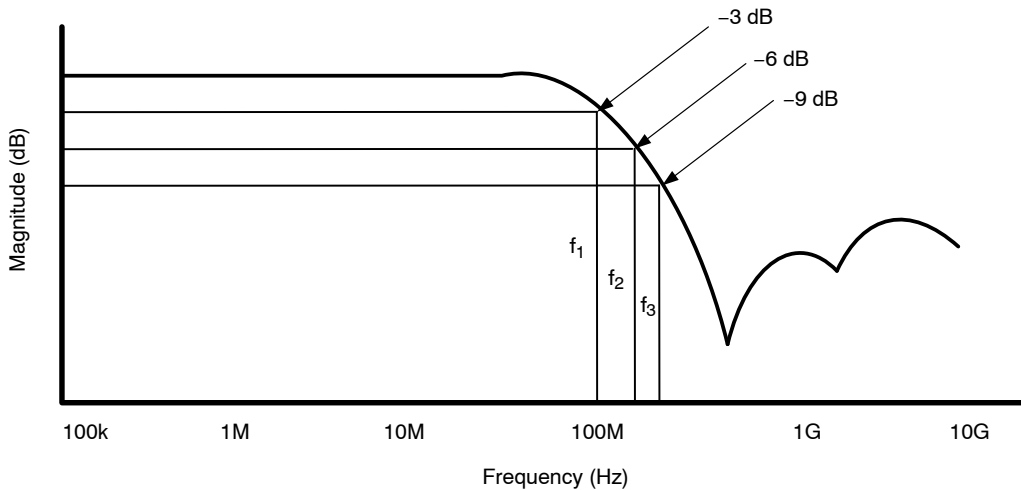

**Figure 8. Filter Bandwidth**

From the above paragraphs it is shown that the maximum supported frequency of a waveform that can be passed through the filter can be found by dividing the bandwidth by a factor of three (to obtain the corresponding data rate

multiply the result by two). The following table gives the bandwidth values and the corresponding maximum supported frequencies and the third harmonic frequencies.

**Table 2. Frequency Chart**

Bandwidth	Maximum Supported Frequency	Third Harmonic Frequency
3 dB – 100 MHz	33.33 MHz ( $f_1$ )	100 MHz
6 dB – 200 MHz	66.67 MHz ( $f_2$ )	200 MHz
9 dB – 300 MHz	100 MHz ( $f_3$ )	300 MHz

Considering that 85% of the amplitude of the square is in the first two terms of the Fourier series approximation most of the signal content is at the fundamental (maximum supported) frequency and the third harmonic frequency. If a signal with a frequency of 33.33 MHz is input to this filter, the first two terms are sufficiently passed such that the signal is only mildly affected, as is shown in Figure 9a. If a signal

with a frequency of 66.67 MHz is input to this same filter, the third harmonic term is significantly attenuated. This serves to round the signal edges and skew the waveform, as is shown in Figure 9b. In the case that a 100 MHz signal is input to this filter, the third harmonic term is attenuated even further and results in even more rounding of the signal edges as is shown in Figure 9c. The result is the degradation of the data being transmitted making the digital data (1's and 0's) more difficult to discern. This does not include effects of other components such as interconnect and other path losses which could further serve to degrade the signal integrity. While some filter products may specify the 6 dB or 9 dB bandwidths, actually using these to calculate supported frequencies (and corresponding data rates) results in significant signal degradation. *To ensure the best signal integrity possible, it is best to use the 3 dB bandwidth to calculate the achievable data rate.*

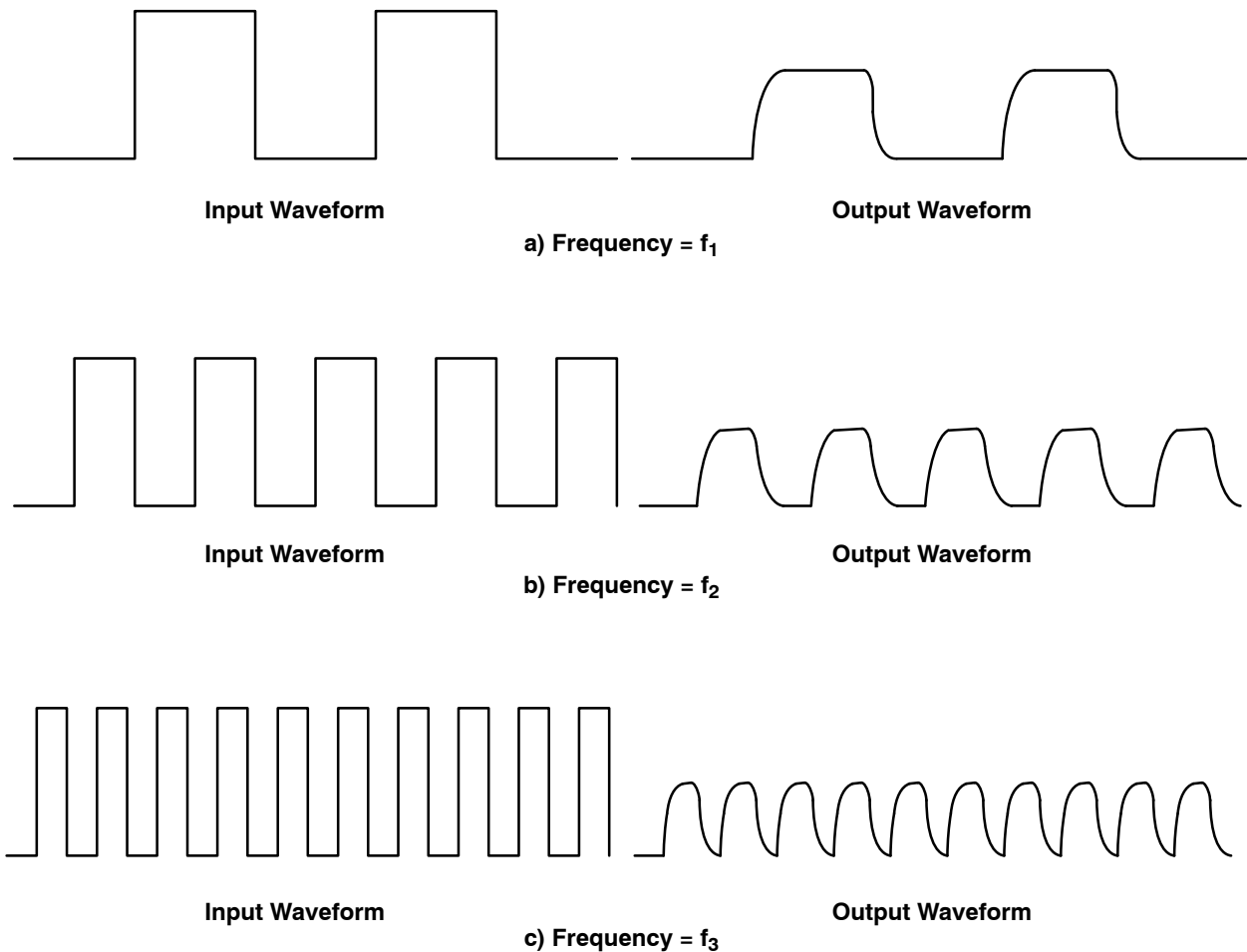

**Figure 9. Input and Output Waveforms of Filter**

# MECHANICAL CASE OUTLINE

## PACKAGE DIMENSIONS

ON Semiconductor®



**DFN12 3.0x1.35, 0.5P**  
CASE 506AD-01  
ISSUE J

DATE 09 JUL 2008

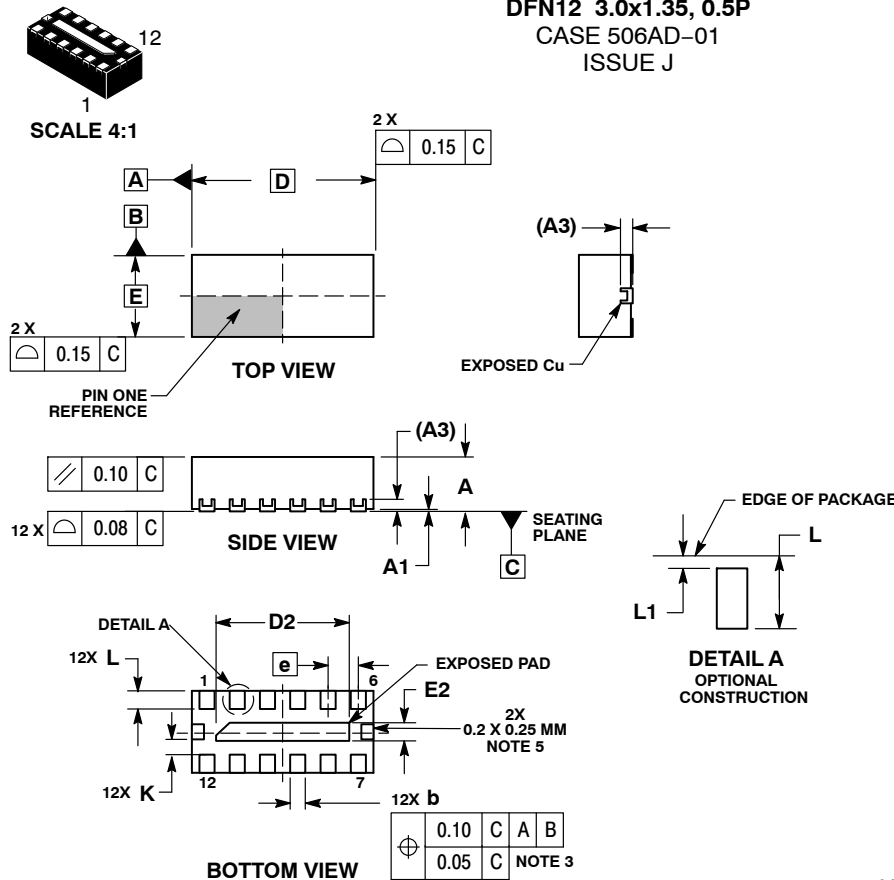

- NOTES:
- DIMENSIONING AND TOLERANCING PER ASME Y14.5M, 1994.
  - CONTROLLING DIMENSION: MILLIMETER.
  - DIMENSION b APPLIES TO PLATED TERMINAL AND IS MEASURED BETWEEN 0.25 AND 0.30 MM FROM TERMINAL.
  - COPLANARITY APPLIES TO THE EXPOSED PAD AS WELL AS THE TERMINALS.
  - EXPOSED PADS CONNECTED TO DIE FLAG. USED AS TEST CONTACTS.

DIM	MILLIMETERS	
	MIN	MAX
A	0.80	1.00
A1	0.00	0.05
A3	0.20	REF
b	0.18	0.30
D	3.00 BSC	
D2	2.10	2.30
E	1.35 BSC	
E2	0.20	0.40
e	0.50 BSC	
K	0.20	---
L	0.20	0.40
L1	0.00	0.15

### GENERIC MARKING DIAGRAM\*

- XXXX = Specific Device Code
- M = Month Code
- = Pb-Free Package

(Note: Microdot may be in either location)

\*This information is generic. Please refer to device data sheet for actual part marking.

Pb-Free indicator, "G" or microdot "▪", may or may not be present.

#### STYLE 1:

- PIN 1. ANODE 1
- 2. ANODE 2
- 3. ANODE 3
- 4. ANODE 4
- 5. ANODE 5
- 6. ANODE 6
- 7. ANODE 7
- 8. ANODE 8
- 9. ANODE 9
- 10. ANODE 10
- 11. ANODE 11
- 12. ANODE 12

### SOLDERING FOOTPRINT\*

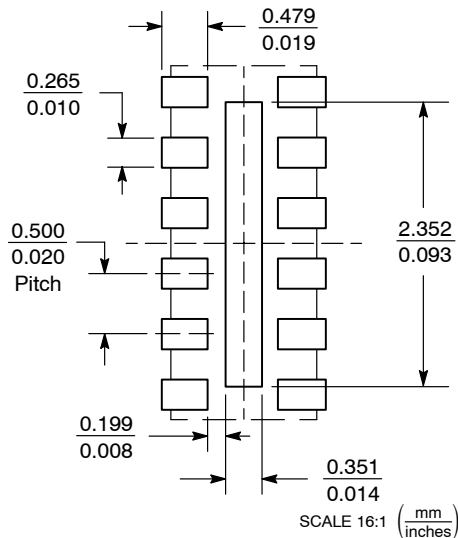

\*For additional information on our Pb-Free strategy and soldering details, please download the ON Semiconductor Soldering and Mounting Techniques Reference Manual, SOLDERRM/D.

<b>DOCUMENT NUMBER:</b>	<b>98AON19409D</b>	Electronic versions are uncontrolled except when accessed directly from the Document Repository. Printed versions are uncontrolled except when stamped "CONTROLLED COPY" in red.
<b>DESCRIPTION:</b>	<b>DFN12 3.0x1.35, 0.5 MM PITCH</b>	<b>PAGE 1 OF 1</b>

ON Semiconductor and ON are trademarks of Semiconductor Components Industries, LLC dba ON Semiconductor or its subsidiaries in the United States and/or other countries. ON Semiconductor reserves the right to make changes without further notice to any products herein. ON Semiconductor makes no warranty, representation or guarantee regarding the suitability of its products for any particular purpose, nor does ON Semiconductor assume any liability arising out of the application or use of any product or circuit, and specifically disclaims any and all liability, including without limitation special, consequential or incidental damages. ON Semiconductor does not convey any license under its patent rights nor the rights of others.

# MECHANICAL CASE OUTLINE

## PACKAGE DIMENSIONS

ON Semiconductor®

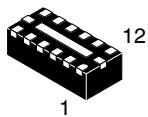

DFNW12 3x1.35, 0.5P  
CASE 507AY  
ISSUE O

DATE 13 JUN 2019

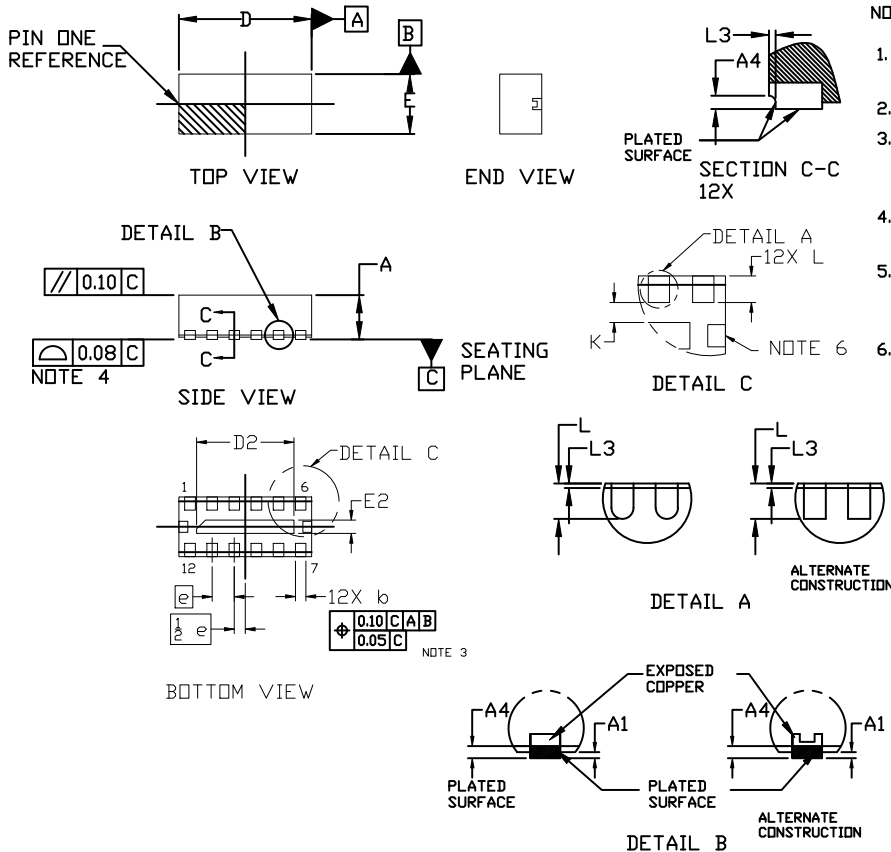

**NOTES:**

1. DIMENSIONING AND TOLERANCING PER ASME Y14.5M, 1994.
2. CONTROLLING DIMENSION: MILLIMETERS
3. DIMENSION *b* APPLIES TO PLATED TERMINALS AND IS MEASURED BETWEEN 0.15 AND 0.30MM FROM THE TERMINAL TIP.
4. COPLANARITY APPLIES TO THE EXPOSED PAD AS WELL AS THE TERMINALS.
5. THIS DEVICE CONTAINS WETTABLE FLANK DESIGN FEATURES TO AID IN FILLET FORMATION ON THE LEADS DURING MOUNTING.
6. EXPOSED PADS CONNECTED TO DIE FLAG USED AS TEST CONTACTS. SIZE (0.20 X 0.25mm)

DIM	MILLIMETERS		
	MIN.	NDM.	MAX.
A	0.80	0.90	1.00
A1	0.00	---	0.05
A3	0.20 REF		
A4	0.10	---	---
<i>b</i>	0.18	0.24	0.30
D	2.85	3.00	3.15
D2	2.10	2.20	2.30
E	1.20	1.35	1.50
E2	0.20	0.30	0.40
<i>e</i>	0.50 BSC		
K	0.20	---	---
L	0.20	0.30	0.40
L3	---	---	0.10

**GENERIC MARKING DIAGRAM\***

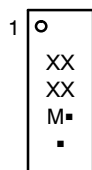

- XX = Specific Device Code
- M = Date Code
- = Pb-Free Package

(Note: Microdot may be in either location)

\*This information is generic. Please refer to device data sheet for actual part marking. Pb-Free indicator, "G" or microdot "▪", may or may not be present. Some products may not follow the Generic Marking.

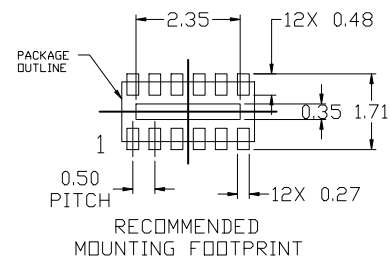

RECOMMENDED MOUNTING FOOTPRINT  
\* For additional information on our Pb-Free strategy and soldering details, please download the ON Semiconductor Soldering and Mounting Techniques Reference Manual, SOLDERRM/D.

<b>DOCUMENT NUMBER:</b>	<b>98AON08530H</b>	Electronic versions are uncontrolled except when accessed directly from the Document Repository. Printed versions are uncontrolled except when stamped "CONTROLLED COPY" in red.
<b>DESCRIPTION:</b>	<b>DFNW12 3x1.35, 0.5P</b>	<b>PAGE 1 OF 1</b>

ON Semiconductor and ON are trademarks of Semiconductor Components Industries, LLC dba ON Semiconductor or its subsidiaries in the United States and/or other countries. ON Semiconductor reserves the right to make changes without further notice to any products herein. ON Semiconductor makes no warranty, representation or guarantee regarding the suitability of its products for any particular purpose, nor does ON Semiconductor assume any liability arising out of the application or use of any product or circuit, and specifically disclaims any and all liability, including without limitation special, consequential or incidental damages. ON Semiconductor does not convey any license under its patent rights nor the rights of others.



**onsemi**, **Onsemi**, and other names, marks, and brands are registered and/or common law trademarks of Semiconductor Components Industries, LLC dba "**onsemi**" or its affiliates and/or subsidiaries in the United States and/or other countries. **onsemi** owns the rights to a number of patents, trademarks, copyrights, trade secrets, and other intellectual property. A listing of **onsemi**'s product/patent coverage may be accessed at [www.onsemi.com/site/pdf/Patent-Marking.pdf](http://www.onsemi.com/site/pdf/Patent-Marking.pdf). **onsemi** reserves the right to make changes at any time to any products or information herein, without notice. The information herein is provided "as-is" and **onsemi** makes no warranty, representation or guarantee regarding the accuracy of the information, product features, availability, functionality, or suitability of its products for any particular purpose, nor does **onsemi** assume any liability arising out of the application or use of any product or circuit, and specifically disclaims any and all liability, including without limitation special, consequential or incidental damages. Buyer is responsible for its products and applications using **onsemi** products, including compliance with all laws, regulations and safety requirements or standards, regardless of any support or applications information provided by **onsemi**. "Typical" parameters which may be provided in **onsemi** data sheets and/or specifications can and do vary in different applications and actual performance may vary over time. All operating parameters, including "Typicals" must be validated for each customer application by customer's technical experts. **onsemi** does not convey any license under any of its intellectual property rights nor the rights of others. **onsemi** products are not designed, intended, or authorized for use as a critical component in life support systems or any FDA Class 3 medical devices or medical devices with a same or similar classification in a foreign jurisdiction or any devices intended for implantation in the human body. Should Buyer purchase or use **onsemi** products for any such unintended or unauthorized application, Buyer shall indemnify and hold **onsemi** and its officers, employees, subsidiaries, affiliates, and distributors harmless against all claims, costs, damages, and expenses, and reasonable attorney fees arising out of, directly or indirectly, any claim of personal injury or death associated with such unintended or unauthorized use, even if such claim alleges that **onsemi** was negligent regarding the design or manufacture of the part. **onsemi** is an Equal Opportunity/Affirmative Action Employer. This literature is subject to all applicable copyright laws and is not for resale in any manner.

## PUBLICATION ORDERING INFORMATION

### LITERATURE FULFILLMENT:

Email Requests to: [orderlit@onsemi.com](mailto:orderlit@onsemi.com)

**onsemi Website:** [www.onsemi.com](http://www.onsemi.com)

### TECHNICAL SUPPORT

**North American Technical Support:**

Voice Mail: 1 800-282-9855 Toll Free USA/Canada

Phone: 011 421 33 790 2910

**Europe, Middle East and Africa Technical Support:**

Phone: 00421 33 790 2910

For additional information, please contact your local Sales Representative