

NB3N3002

3.3V, Crystal to 25MHz, 100MHz, 125MHz and 200MHz HCSL Clock Generator



ON Semiconductor®

www.onsemi.com

Description

The NB3N3002 is a precision, low phase noise clock generator that supports PCI-Express and Ethernet requirements. The device accepts a 25 MHz fundamental mode parallel resonant crystal and generates a differential HCSL output at 25 MHz, 100 MHz, 125 MHz or 200 MHz clock frequencies. Outputs can interface with LVDS with proper termination (See Figure 5).

This device is housed in 5.0 mm x 4.4 mm narrow body TSSOP 16 pin package.

Features

- Uses 25 MHz Fundamental Mode Parallel Resonant Crystal
- External Loop Filter is Not Required
- HCSL Differential Output or LVDS with Proper Termination
- For Selectable Multipliers of the Input Frequency
- Output Enable with Tri-State Outputs
- PCIe Gen1, Gen2, Gen3, Gen4, QPI, UPI Jitter Compliant
- Typical TIE RMS jitter of 2.5 ps
- Phase Noise: @ 100 MHz

Offset	Noise Power
100 Hz	-109.4 dBc
1 kHz	-127.8 dBc
10 kHz	-136.2 dBc
100 kHz	-138.8 dBc
1 MHz	-138.2 dBc
10 MHz	-161.4 dBc
20 MHz	-163.00 dBc
- Operating Range 3.3 V \pm 5%
- Industrial Temperature Range -40°C to +85°C
- These are Pb-Free Devices

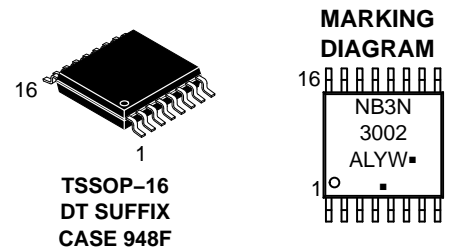

- A = Assembly Location
- L = Wafer Lot
- Y = Year
- W = Work Week
- = Pb-Free Package

(Note: Microdot may be in either location)

ORDERING INFORMATION

See detailed ordering and shipping information in the package dimensions section on page 6 of this data sheet.

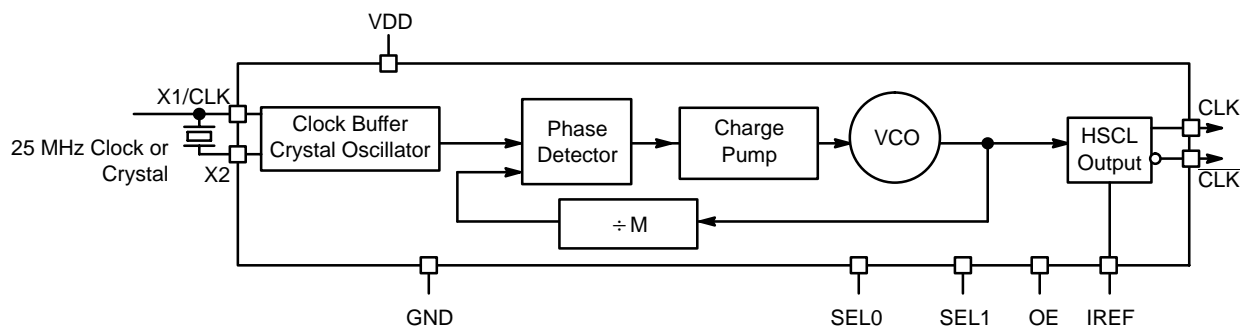

Figure 1. NB3N3002 Simplified Logic Diagram

NB3N3002

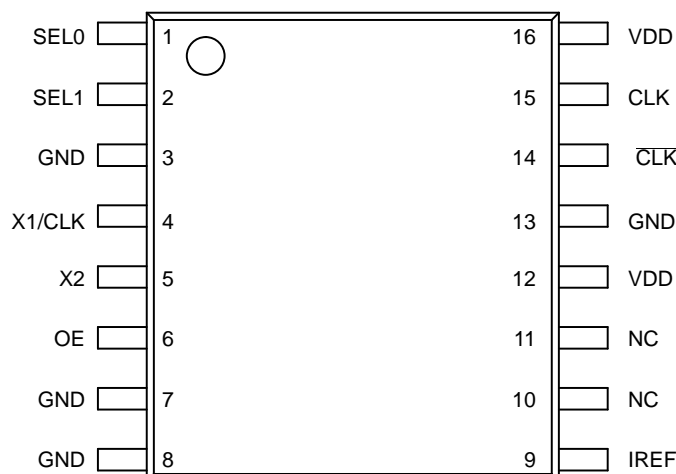

Figure 2. Pin Configuration (Top View)

Table 1. PIN DESCRIPTION

Pin	Symbol	I/O	Description
1	Sel0	Input	LVTTL/LVCMOS frequency select input 0. Internal pullup resistor to V_{DD} . See output select table 2 for details.
2	Sel1	Input	LVTTL/LVCMOS frequency select input 1. Internal pullup resistor to V_{DD} . See output select Table 2 for details.
12, 16	V_{DD}	Power Supply	Positive supply voltage pins are connected to +3.3 V supply voltage.
4	X1/CLK	Input	Crystal or Clock input. Connect to 25 MHz crystal source or single-ended clock.
5	X2	Input	Crystal input. Connect to a 25 MHz crystal or leave unconnected for clock input.
6	OE	Input	Output enable tri-states output when connected to GND. Internal pullup resistor to V_{DD} .
3, 7, 8, 13	GND	Power Supply	Ground 0 V. These pins provide GND return path for the devices.
9	I _{REF}	Output	Output current reference pin. Precision resistor (typ. 475 Ω) is connected from pin 9 to GND to set the output current.
15	CLK	HCSL or LVDS Output	Noninverted clock output. (For LVDS levels see Figure 5)
14	$\overline{\text{CLK}}$	HCSL or LVDS Output	Inverted clock output. (For LVDS levels see Figure 5)
10,11	NC		Do not connect

Table 2. OUTPUT FREQUENCY SELECT TABLE WITH 25MHz CRYSTALS

SEL1*	SEL0*	CLK Multiplier	f_{CLK} (MHz)
L	L	1x	25
L	H	4x	100
H	L	5x	125
H	H	8x	200

*Pins SEL1 and SEL0 default high when left open.

Recommended Crystal Parameters

Crystal	Fundamental AT-Cut
Frequency	25 MHz
Load Capacitance	16–20 pF
Shunt Capacitance, C_0	7 pF Max
Equivalent Series Resistance	50 Ω Max
Initial Accuracy at 25 °C	± 20 ppm
Temperature Stability	± 30 ppm
Aging	± 20 ppm

NB3N3002

Table 3. ATTRIBUTES

Characteristic	Value
ESD Protection Human Body Model	> 2 kV
RPU – OE, SEL0 and SEL1 Pull-up Resistor	100 kΩ
Moisture Sensitivity, Indefinite Time Out of Dry Pack (Note 1)	Level 1
Flammability Rating Oxygen Index: 28 to 34	UL 94 V-0 @ 0.125 in
Transistor Count	7623
Meets or exceeds JEDEC Spec EIA/JESD78 IC Latchup Test	

1. For additional information, see Application Note AND8003/D.

Table 4. MAXIMUM RATINGS (Note 2)

Symbol	Parameter	Condition 1	Condition 2	Rating	Units
V _{DD}	Positive Power Supply	GND = 0 V		4.6	V
V _I	Input Voltage (V _{IN})	GND = 0 V	GND ≤ V _I ≤ V _{DD}	-0.5 V to V _{DD} +0.5 V	V
T _A	Operating Temperature Range			-40 to +85	°C
T _{stg}	Storage Temperature Range			-65 to +150	°C
θ _{JA}	Thermal Resistance (Junction-to-Ambient)	0 lfpm 500 lfpm	TSSOP-16 TSSOP-16	138 108	°C/W °C/W
θ _{JC}	Thermal Resistance (Junction-to-Case)	(Note 3)	TSSOP-16	33 to 36	°C/W
T _{sol}	Wave Solder			265	°C

Stresses exceeding those listed in the Maximum Ratings table may damage the device. If any of these limits are exceeded, device functionality should not be assumed, damage may occur and reliability may be affected.

- Maximum ratings applied to the device are individual stress limit values (not normal operating conditions) and not valid simultaneously. If stress limits are exceeded device functional operation is not implied, damage may occur and reliability may be affected.
- JEDEC standard multilayer board – 2S2P (2 signal, 2 power).

Table 5. DC CHARACTERISTICS (V_{DD} = 3.3 V ±5%, GND = 0 V, T_A = -40°C to +85°C)

Symbol	Characteristic	Min	Typ	Max	Unit
I _{DD}	Power Supply Current (Note 4)	65		95	mA
I _{DDOE}	Power Supply Current when OE is Set Low	35		65	mA
V _{IH}	Input HIGH Voltage (X1/CLK, Sel0, Sel1, and OE)	0.7 * V _{DD}		V _{DD} + 300	mV
V _{IL}	Input LOW Voltage (X1/CLK, Sel0, Sel1, and OE)	GND – 300		0.3* V _{DD}	mV
V _{OH}	Output HIGH Voltage (See Figure 4)	660	700	850	mV
V _{OL}	Output LOW Voltage (See Figure 4)	-150	0	150	mV
V _{cross}	Crossing Voltage Magnitude (Absolute)	250		400	mV
ΔV _{cross}	Change in Magnitude of V _{cross}			150	mV

NOTE: Device will meet the specifications after thermal equilibrium has been established when mounted in a test socket or printed circuit board with maintained transverse airflow greater than 500 lfpm.

- NB3N circuits are designed to meet the DC specifications shown in the above table after thermal equilibrium has been established. The circuit is in a test socket or mounted on a printed circuit board and transverse airflow greater than 500 lfpm is maintained.
- Measurement taken with outputs terminated with R_S = 33.2 Ω, R_L = 49.9 Ω, with load capacitance of 2 pF and current biasing resistor, R_{REF} from I_{REF} (Pin 9) to GND of 475 Ω. See Figure 3.

NB3N3002

Table 6. AC CHARACTERISTICS ($V_{DD} = 3.3\text{ V} \pm 5\%$, $GND = 0\text{ V}$, $T_A = -40^\circ\text{C}$ to $+85^\circ\text{C}$; Note 7)

Symbol	Characteristic	Min	Typ	Max	Unit	
f_{CLKIN}	Clock/Crystal Input Frequency		25		MHz	
f_{CLKOUT}	Output Clock Frequency	25		200	MHz	
θ_{NOISE}	Phase-Noise Performance	$f_{CLK} = 200\text{ MHz}/100\text{ MHz}$			dBc/Hz	
		@ 100 Hz offset from carrier		-103/-109		
		@ 1 kHz offset from carrier		-118/-127.8		
		@ 10 kHz offset from carrier		-122/-136.2		
		@ 100 kHz offset from carrier		-130/-138.8		
		@ 1 MHz offset from carrier		-138/-138.2		
	@ 10 MHz offset from carrier		-149/-164			
$t_{jit(\phi)}$	RMS Phase Jitter (at 125 MHz @ 1 MHz – 40 MHz)		0.25	0.50	ps	
t_{jitter} (TIE)	TIE RMS Jitter (Note 8)	$f_{CLK} = 200\text{ MHz}$		2.5	ps	
	Cycle-to-Cycle RMS Jitter (Note 9)	$f_{CLK} = 200\text{ MHz}$		2		5
	Cycle-to-Cycle Peak to Peak Jitter (Note 9)	$f_{CLK} = 200\text{ MHz}$		20		35
	Period RMS Jitter (Note 9)	$f_{CLK} = 200\text{ MHz}$		1.5		3
	Period Peak-to-Peak Jitter (Note 9)	$f_{CLK} = 200\text{ MHz}$		10		20
OE	Output Enable/Disable Time			1.0	μs	
t_{DUTY_CYCLE}	Output Clock Duty Cycle (Measured at cross point)	45	50	55	%	
t_R	Output Risetime (Measured from 175 mV to 525 mV, Figure 4)	175	340	700	ps	
t_F	Output Falltime (Measured from 525 mV to 175 mV, Figure 4)	175	340	700	ps	
Δt_R	Output Risetime Variation (Single-Ended)			125	ps	
Δt_F	Output Falltime Variation (Single-Ended)			125	ps	

NOTE: Device will meet the specifications after thermal equilibrium has been established when mounted in a test socket or printed circuit board with maintained transverse airflow greater than 500 lfm.

6. NB3N circuits are designed to meet the DC specifications shown in the above table after thermal equilibrium has been established. The circuit is in a test socket or mounted on a printed circuit board and transverse airflow greater than 500 lfm is maintained.
7. Measurement taken from differential output on single-ended channel terminated with $R_S = 33.2\ \Omega$, $R_L = 49.9\ \Omega$, with load capacitance of 2 pF and current biasing resistor, R_{REF} , from I_{REF} (Pin 9) to GND of 475 Ω . See Figures 3 and 4.
8. Sampled with 20000 cycles to capture jitter component down to 100 kHz.
9. Sampled with 20000 cycles.

Table 7. AC ELECTRICAL CHARACTERISTICS – PCI EXPRESS JITTER SPECIFICATIONS,

$V_{DD} = 3.3 V \pm 5\%$, $T_A = -40^{\circ}C$ to $85^{\circ}C$

Symbol	Parameter	Conditions (Notes 10 and 11)	Min	Typ	Max	Industry Limit	Unit
$t_{jphPCleG1}$	RMS Phase Jitter	PCIe Gen 1 (Notes 12 and 13)		10	16	86	ps (p-p)
$t_{jphPCleG2}$		PCIe Gen 2 Lo Band 10 kHz < f < 1.5 MHz (Note 12)		0.2	0.25	3	ps (rms)
		PCIe Gen 2 High Band 1.5 MHz < f < Nyquist (50 MHz) (Note 12)		0.9	1.2	3.1	ps (rms)
$t_{jphPCleG3}$		PCIe Gen 3 (PLL BW of 2–4 MHz, CDR = 10 MHz) (Note 12)		0.2	0.3	1	ps (rms)
$t_{jphPCleG4}$		PCIe Gen 4 (PLL BW of 2–4 MHz, CDR = 10 MHz) (Note 12)		0.21	0.3	0.5	ps (rms)
t_{jphUPI}		UPI (9.6 Gb/s, 10.4 Gb/s or 11.2 Gb/s, 100 MHz, 12 UI)		0.62	0.7	1.0	ps (rms)
t_{jphQPI_SMI}		QPI & SMI (100.00 MHz or 133.33 MHz, 4.8 Gb/s, 6.4 Gb/s 12UI) (Note 14)		0.1	0.3	0.5	ps (rms)
		QPI & SMI (100.00 MHz, 8.0 Gb/s, 12UI) (Note 14)		0.1	0.15	0.3	ps (rms)
		QPI & SMI (100.00 MHz, 9.6 Gb/s, 12UI) (Note 14)		0.07	0.1	0.2	ps (rms)

Product parametric performance is indicated in the Electrical Characteristics for the listed test conditions, unless otherwise noted. Product performance may not be indicated by the Electrical Characteristics if operated under different conditions.

10. Applies to all outputs.

11. Guaranteed by design and characterization, not tested in production

12. See <http://www.pcisig.com> for complete specs

13. Sample size of at least 100K cycles. This figures extrapolates to 108 ps pk-pk @ 1M cycles for a BER of 1-12.

14. Calculated from Intel-supplied Clock Jitter Tool v 1.6.3.

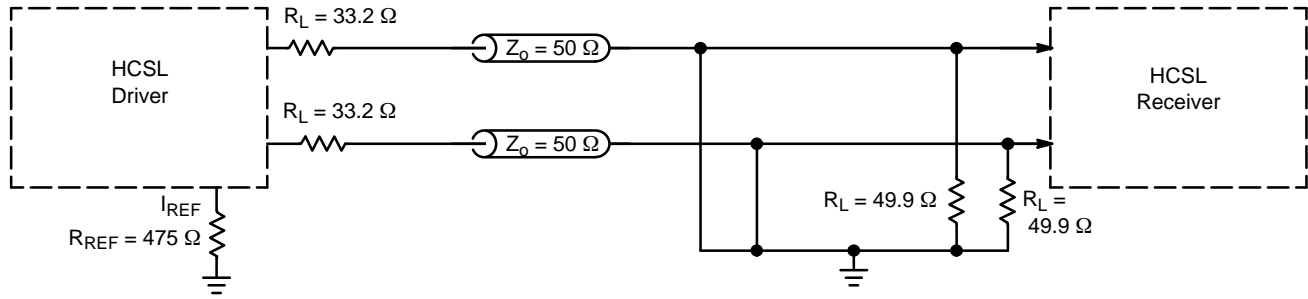

Figure 3. Typical Termination for Output Driver and Device Evaluation

NB3N3002

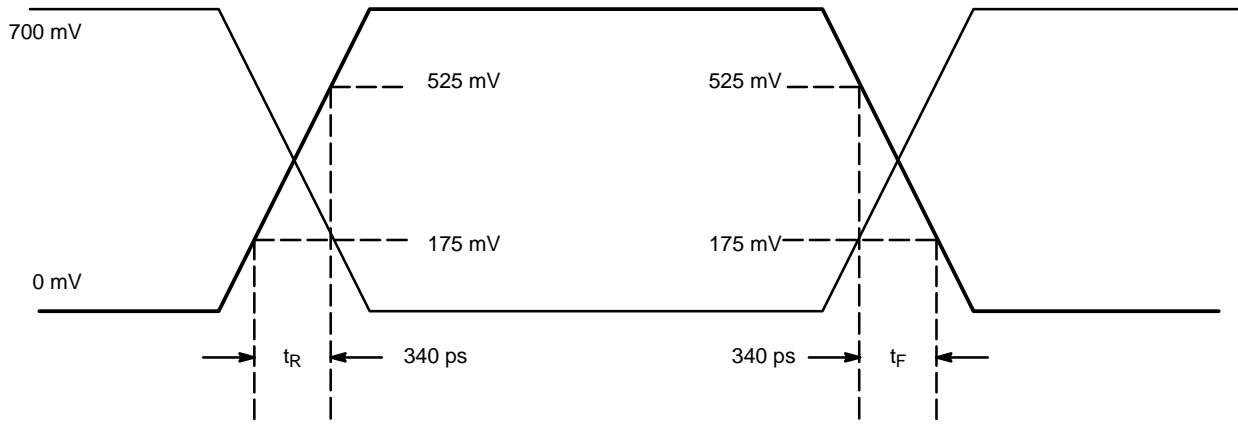

Figure 4. HCSL Output Parameter Characteristics

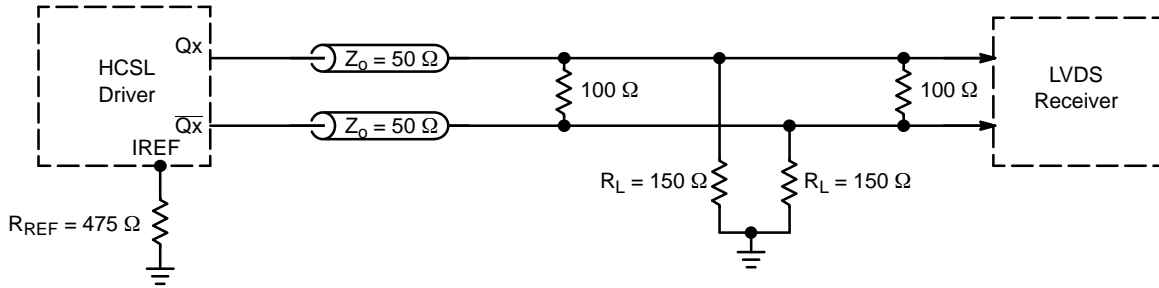

Figure 5. HCSL Interface Termination to LVDS

ORDERING INFORMATION

Device	Package	Shipping†
NB3N3002DTG	TSSOP-16 (Pb-Free)	96 Units / Rail
NB3N3002DTR2G	TSSOP-16 (Pb-Free)	2500 / Tape & Reel

†For information on tape and reel specifications, including part orientation and tape sizes, please refer to our Tape and Reel Packaging Specifications Brochure, BRD8011/D.

MECHANICAL CASE OUTLINE PACKAGE DIMENSIONS

ON Semiconductor®



TSSOP-16
CASE 948F-01
ISSUE B

DATE 19 OCT 2006



- NOTES:
1. DIMENSIONING AND TOLERANCING PER ANSI Y14.5M, 1982.
 2. CONTROLLING DIMENSION: MILLIMETER.
 3. DIMENSION A DOES NOT INCLUDE MOLD FLASH. PROTRUSIONS OR GATE BURRS. MOLD FLASH OR GATE BURRS SHALL NOT EXCEED 0.15 (0.006) PER SIDE.
 4. DIMENSION B DOES NOT INCLUDE INTERLEAD FLASH OR PROTRUSION. INTERLEAD FLASH OR PROTRUSION SHALL NOT EXCEED 0.25 (0.010) PER SIDE.
 5. DIMENSION K DOES NOT INCLUDE DAMBAR PROTRUSION. ALLOWABLE DAMBAR PROTRUSION SHALL BE 0.08 (0.003) TOTAL IN EXCESS OF THE K DIMENSION AT MAXIMUM MATERIAL CONDITION.
 6. TERMINAL NUMBERS ARE SHOWN FOR REFERENCE ONLY.
 7. DIMENSION A AND B ARE TO BE DETERMINED AT DATUM PLANE -W-.

DIM	MILLIMETERS		INCHES	
	MIN	MAX	MIN	MAX
A	4.90	5.10	0.193	0.200
B	4.30	4.50	0.169	0.177
C	---	1.20	---	0.047
D	0.05	0.15	0.002	0.006
F	0.50	0.75	0.020	0.030
G	0.65 BSC		0.026 BSC	
H	0.18	0.28	0.007	0.011
J	0.09	0.20	0.004	0.008
J1	0.09	0.16	0.004	0.006
K	0.19	0.30	0.007	0.012
K1	0.19	0.25	0.007	0.010
L	6.40 BSC		0.252 BSC	
M	0°	8°	0°	8°

SOLDERING FOOTPRINT

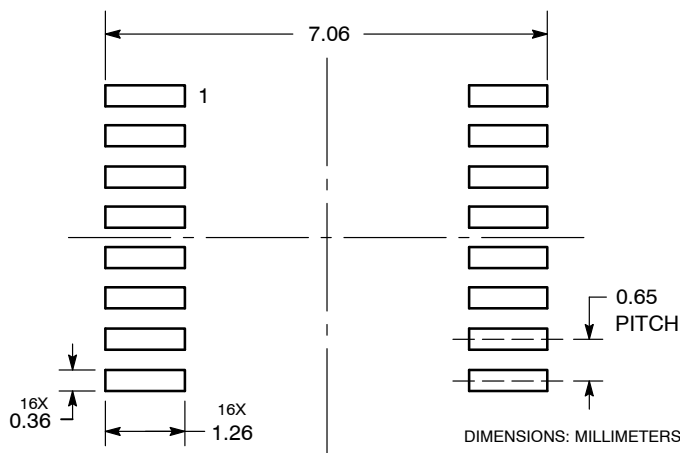

GENERIC MARKING DIAGRAM*

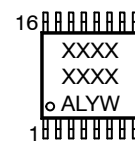

- XXXX = Specific Device Code
- A = Assembly Location
- L = Wafer Lot
- Y = Year
- W = Work Week
- G or ■ = Pb-Free Package

*This information is generic. Please refer to device data sheet for actual part marking. Pb-Free indicator, "G" or microdot "■", may or may not be present.

DOCUMENT NUMBER:	98ASH70247A	Electronic versions are uncontrolled except when accessed directly from the Document Repository. Printed versions are uncontrolled except when stamped "CONTROLLED COPY" in red.
DESCRIPTION:	TSSOP-16	PAGE 1 OF 1

ON Semiconductor and ON are trademarks of Semiconductor Components Industries, LLC dba ON Semiconductor or its subsidiaries in the United States and/or other countries. ON Semiconductor reserves the right to make changes without further notice to any products herein. ON Semiconductor makes no warranty, representation or guarantee regarding the suitability of its products for any particular purpose, nor does ON Semiconductor assume any liability arising out of the application or use of any product or circuit, and specifically disclaims any and all liability, including without limitation special, consequential or incidental damages. ON Semiconductor does not convey any license under its patent rights nor the rights of others.

onsemi, **Onsemi**, and other names, marks, and brands are registered and/or common law trademarks of Semiconductor Components Industries, LLC dba "**onsemi**" or its affiliates and/or subsidiaries in the United States and/or other countries. **onsemi** owns the rights to a number of patents, trademarks, copyrights, trade secrets, and other intellectual property. A listing of **onsemi**'s product/patent coverage may be accessed at www.onsemi.com/site/pdf/Patent-Marking.pdf. **onsemi** reserves the right to make changes at any time to any products or information herein, without notice. The information herein is provided "as-is" and **onsemi** makes no warranty, representation or guarantee regarding the accuracy of the information, product features, availability, functionality, or suitability of its products for any particular purpose, nor does **onsemi** assume any liability arising out of the application or use of any product or circuit, and specifically disclaims any and all liability, including without limitation special, consequential or incidental damages. Buyer is responsible for its products and applications using **onsemi** products, including compliance with all laws, regulations and safety requirements or standards, regardless of any support or applications information provided by **onsemi**. "Typical" parameters which may be provided in **onsemi** data sheets and/or specifications can and do vary in different applications and actual performance may vary over time. All operating parameters, including "Typicals" must be validated for each customer application by customer's technical experts. **onsemi** does not convey any license under any of its intellectual property rights nor the rights of others. **onsemi** products are not designed, intended, or authorized for use as a critical component in life support systems or any FDA Class 3 medical devices or medical devices with a same or similar classification in a foreign jurisdiction or any devices intended for implantation in the human body. Should Buyer purchase or use **onsemi** products for any such unintended or unauthorized application, Buyer shall indemnify and hold **onsemi** and its officers, employees, subsidiaries, affiliates, and distributors harmless against all claims, costs, damages, and expenses, and reasonable attorney fees arising out of, directly or indirectly, any claim of personal injury or death associated with such unintended or unauthorized use, even if such claim alleges that **onsemi** was negligent regarding the design or manufacture of the part. **onsemi** is an Equal Opportunity/Affirmative Action Employer. This literature is subject to all applicable copyright laws and is not for resale in any manner.

PUBLICATION ORDERING INFORMATION

LITERATURE FULFILLMENT:

Email Requests to: orderlit@onsemi.com

onsemi Website: www.onsemi.com

TECHNICAL SUPPORT

North American Technical Support:

Voice Mail: 1 800-282-9855 Toll Free USA/Canada

Phone: 011 421 33 790 2910

Europe, Middle East and Africa Technical Support:

Phone: 00421 33 790 2910

For additional information, please contact your local Sales Representative