

# 6-Pin DIP High Voltage Phototransistor Optocouplers

## 4N38M, H11D1M, H11D3M, MOC8204M

### Description

The 4N38M, H11D1M, H11D3M and MOC8204M are phototransistor-type optically coupled optoisolators. A gallium arsenide infrared emitting diode is coupled with a high voltage NPN silicon phototransistor. The device is supplied in a standard plastic six-pin dual-in-line package.

### Features

- High Voltage:
  - ◆ MOC8204M,  $BV_{CEO} = 400\text{ V}$
  - ◆ H11D1M,  $BV_{CEO} = 300\text{ V}$
  - ◆ H11D3M,  $BV_{CEO} = 200\text{ V}$
- Safety and Regulatory Approvals:
  - ◆ UL1577, 4,170 VAC<sub>RMS</sub> for 1 Minute
- DIN-EN/IEC60747-5-5, 850 V Peak Working Insulation Voltage

### Applications

- Power Supply Regulators
- Digital Logic Inputs
- Microprocessor Inputs
- Appliance Sensor Systems
- Industrial Controls

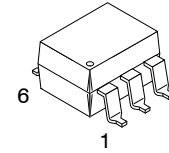

PDIP6  
CASE 646BY

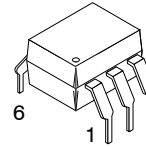

PDIP6  
CASE 646BZ

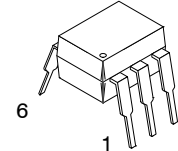

PDIP6  
CASE 646BX

### MARKING DIAGRAM

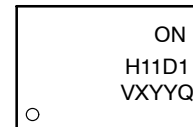

- ON = Company Logo
- H11D1 = Specific Device Code
- V = DIN EN/IEC60747-5-5 Option  
(only appears on component ordered with this option)
- X = One-Digit Year Code
- YY = Digit Work Week
- Q = Assembly Package Code

### ORDERING INFORMATION

See detailed ordering and shipping information on page 410 of this data sheet.

# 4N38M, H11D1M, H11D3M, MOC8204M

## SCHEMATICS

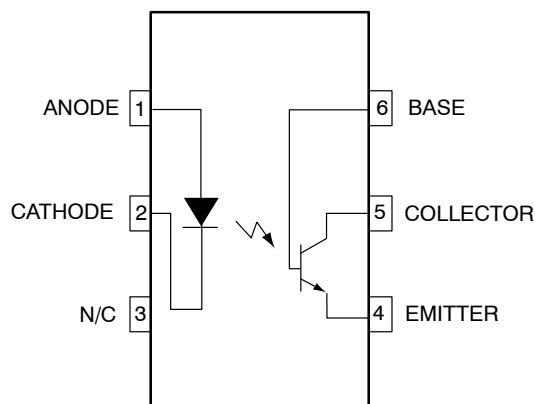

Figure 1. Schematics

## SAFETY AND INSULATION RATINGS

Parameter		Characteristic
Installation Classifications per DIN VDE 0110/1.89 Table 1, For Rated Mains Voltage	< 150 V <sub>RMS</sub>	I – IV
	< 300 V <sub>RMS</sub>	I – IV
Climatic Classification		55/100/21
Pollution Degree (DIN VDE 0110/1.89)		2
Comparative Tracking Index		175

Symbol	Parameter	Value	Unit
V <sub>PR</sub>	Input-to-Output Test Voltage, Method A, V <sub>IORM</sub> x 1.6 = V <sub>PR</sub> , Type and Sample Test with t <sub>m</sub> = 10 s, Partial Discharge < 5 pC	1360	V <sub>peak</sub>
	Input-to-Output Test Voltage, Method B, V <sub>IORM</sub> x 1.875 = V <sub>PR</sub> , 100% Production Test with t <sub>m</sub> = 1 s, Partial Discharge < 5 pC	1594	V <sub>peak</sub>
V <sub>IORM</sub>	Maximum Working Insulation Voltage	850	V <sub>peak</sub>
V <sub>IOTM</sub>	Highest Allowable Over-Voltage	6000	V <sub>peak</sub>
	External Creepage	≥ 7	mm
	External Clearance	≥ 7	mm
	External Clearance (for Option TV, 0.4" Lead Spacing)	≥ 10	mm
DTI	Distance Through Insulation (Insulation Thickness)	≥ 0.5	mm
T <sub>S</sub>	Case Temperature (Note 1)	175	°C
I <sub>S,INPUT</sub>	Input Current (Note 1)	350	mA
P <sub>S,OUTPUT</sub>	Output Power (Note 1)	800	mW
R <sub>IO</sub>	Insulation Resistance at T <sub>S</sub> , V <sub>IO</sub> = 500 V (Note 1)	> 10 <sup>9</sup>	Ω

As per DIN EN/IEC 60747-5-5, this optocoupler is suitable for "safe electrical insulation" only within the safety limit data. Compliance with the safety ratings shall be ensured by means of protective circuits.

1. Safety limit values – maximum values allowed in the event of a failure.

## 4N38M, H11D1M, H11D3M, MOC8204M

### ABSOLUTE MAXIMUM RATINGS

Symbol	Parameter	Device	Value	Unit
<b>TOTAL DEVICE</b>				
T <sub>STG</sub>	Storage Temperature	All	-40 to + 125	°C
T <sub>OPR</sub>	Operating Temperature	All	-40 to + 100	°C
T <sub>J</sub>	Junction Temperature	All	-40 to + 125	°C
T <sub>SOL</sub>	Lead Solder Temperature	All	260 for 10 seconds	°C
P <sub>D</sub>	Total Device Power Dissipation @ T <sub>A</sub> = 25°C	All	420	mW
	Derate Above 25°C		3.5	mW/°C
<b>EMITTER</b>				
I <sub>F</sub>	Forward DC Current (Note 2)	All	80	mA
V <sub>R</sub>	Reverse Input Voltage (Note 2)	All	6.0	V
I <sub>F(pk)</sub>	Forward Current – Peak (1 μs pulse, 300 pps) (Note 2)	All	3.0	A
P <sub>D</sub>	LED Power Dissipation @ T <sub>A</sub> = 25°C (Note 2)	All	120	mW
	Derate Above 25°C		1.41	mW/°C
<b>DETECTOR</b>				
P <sub>D</sub>	Power Dissipation @ T <sub>A</sub> = 25°C	All	300	mW
	Derate Linearly Above 25°C		4.0	mW/°C
V <sub>CEO</sub>	Collector to Emitter Voltage (Note 2)	MOC8204M	400	V
		H11D1M	300	V
		H11D3M	200	V
		4N38M	80	V
V <sub>CBO</sub>	Collector Base Voltage (Note 2)	MOC8204M	400	V
		H11D1M	300	V
		H11D3M	200	V
		4N38M	80	V
V <sub>ECO</sub>	Emitter to Collector Voltage (Note 2)	H11D1M, H11D3M, MOC8204M	7	V
I <sub>C</sub>	Collector Current (Continuous)	All	100	mA

Stresses exceeding those listed in the Maximum Ratings table may damage the device. If any of these limits are exceeded, device functionality should not be assumed, damage may occur and reliability may be affected.

2. Parameters meet or exceed JEDEC registered data (for 4N38M only).

# 4N38M, H11D1M, H11D3M, MOC8204M

## ELECTRICAL CHARACTERISTICS (T<sub>J</sub> = 25°C unless otherwise noted)

Symbol	Characteristic	Test Conditions	Device	Min	Typ	Max	Unit
--------	----------------	-----------------	--------	-----	-----	-----	------

### INDIVIDUAL COMPONENT CHARACTERISTICS

#### Emitter

V <sub>F</sub>	Forward Voltage (Note 3)	I <sub>F</sub> = 10 mA	All	–	1.15	1.50	V
$\frac{\Delta V_F}{\Delta T_A}$	Forward Voltage Temperature Coefficient		All	–	–1.8	–	mV/°C
BV <sub>R</sub>	Reverse Breakdown Voltage	I <sub>R</sub> = 10 μA	All	6	25	–	V
C <sub>J</sub>	Junction Capacitance	V <sub>F</sub> = 0 V, f = 1 MHz	All	–	50	–	pF
		V <sub>F</sub> = 1 V, f = 1 MHz		–	65	–	pF
I <sub>R</sub>	Reverse Leakage Current (Note 3)	V <sub>R</sub> = 6 V	All	–	0.05	10	μA

#### Detector

BV <sub>CEO</sub>	Breakdown Voltage Collector-to-Emitter (Note 3)	R <sub>BE</sub> = 1 MΩ, I <sub>C</sub> = 1.0 mA, I <sub>F</sub> = 0	MOC8204M	400	–	–	V
			H11D1M	300	–	–	V
			H11D3M	200	–	–	V
			No RBE, I <sub>C</sub> = 1.0 mA	4N38M	80	–	–
BV <sub>CBO</sub>	Collector to Base (Note 3)	I <sub>C</sub> = 100 μA, I <sub>F</sub> = 0	MOC8204M	400	–	–	V
			H11D1M	300	–	–	V
			H11D3M	200	–	–	V
			4N38M	80	–	–	V
BV <sub>EBO</sub>	Emitter to Base	I <sub>E</sub> = 100 μA, I <sub>F</sub> = 0	4N38M	7	–	–	V
BV <sub>ECO</sub>	Emitter to Collector	I <sub>E</sub> = 100 μA, I <sub>F</sub> = 0	All	7	10	–	V
I <sub>CEO</sub>	Leakage Current Collector to Emitter (Note 3) (R <sub>BE</sub> = 1 MΩ)	V <sub>CE</sub> = 300 V, I <sub>F</sub> = 0, T <sub>A</sub> = 25°C	MOC8204M	–	–	100	nA
		V <sub>CE</sub> = 300 V, I <sub>F</sub> = 0, T <sub>A</sub> = 100°C		–	–	250	μA
		V <sub>CE</sub> = 200 V, I <sub>F</sub> = 0, T <sub>A</sub> = 25°C	H11D1M	–	–	100	nA
		V <sub>CE</sub> = 200 V, I <sub>F</sub> = 0, T <sub>A</sub> = 100°C		–	–	250	μA
		V <sub>CE</sub> = 100 V, I <sub>F</sub> = 0, T <sub>A</sub> = 25°C	H11D3M	–	–	100	nA
		V <sub>CE</sub> = 100 V, I <sub>F</sub> = 0, T <sub>A</sub> = 100°C		–	–	250	μA
		No R <sub>BE</sub> , V <sub>CE</sub> = 60 V, I <sub>F</sub> = 0, T <sub>A</sub> = 25°C	4N38M	–	–	50	nA

### TRANSFER CHARACTERISTICS

#### Emitter

CTR	Current Transfer Ratio, Collector-to-Emitter	I <sub>F</sub> = 10 mA, V <sub>CE</sub> = 10 V, R <sub>BE</sub> = 1 MΩ	H11D1M, H11D3M, MOC8204M	2 (20)	–	–	mA (%)
		I <sub>F</sub> = 10 mA, V <sub>CE</sub> = 10 V	4N38M	2 (20)	–	–	mA (%)
V <sub>CE(SAT)</sub>	Saturation Voltage (Note 3)	I <sub>F</sub> = 10 mA, I <sub>C</sub> = 0.5 mA, R <sub>BE</sub> = 1 MΩ	H11D1M, H11D3M, MOC8204M	–	0.1	0.4	V
		I <sub>F</sub> = 20 mA, I <sub>C</sub> = 4 mA	4N38M	–	–	1.0	V

#### Switching Times

t <sub>ON</sub>	Non-Saturated Turn-on Time	V <sub>CE</sub> = 10 V, I <sub>C</sub> = 2 mA, R <sub>L</sub> = 100 Ω	All	–	5	–	μs
t <sub>OFF</sub>	Turn-off Time		All	–	5	–	μs

### ISOLATION CHARACTERISTICS

V <sub>ISO</sub>	Input-Output Isolation Voltage	t = 1 Minute	4170	–	–	V <sub>AC(RMS)</sub>
C <sub>ISO</sub>	Isolation Capacitance	V <sub>I-O</sub> = 0 V, f = 1 MHz	–	0.2	–	pF
R <sub>ISO</sub>	Isolation Resistance	V <sub>I-O</sub> = ±500 V <sub>DC</sub> , T <sub>A</sub> = 25°C	10 <sup>11</sup>	–	–	Ω

Product parametric performance is indicated in the Electrical Characteristics for the listed test conditions, unless otherwise noted. Product performance may not be indicated by the Electrical Characteristics if operated under different conditions.

3. Parameters meet or exceed JEDEC registered data (for 4N38M only).

TYPICAL PERFORMANCE CURVES

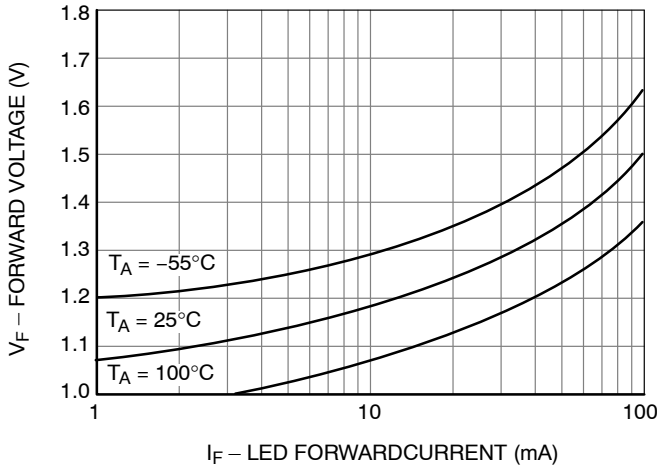

Figure 2. LED Forward Voltage vs. Forward Current

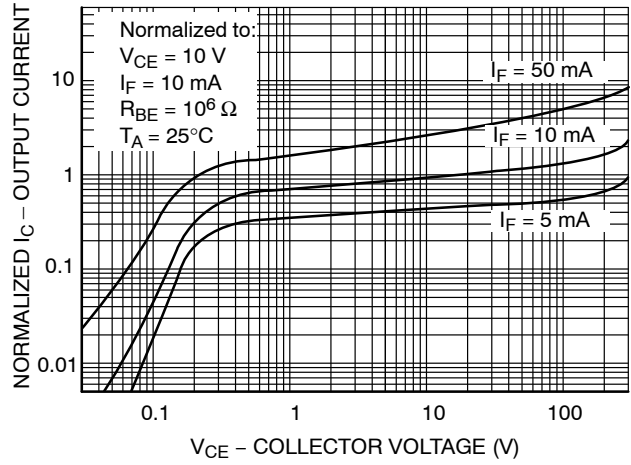

Figure 3. Normalized Output Characteristics

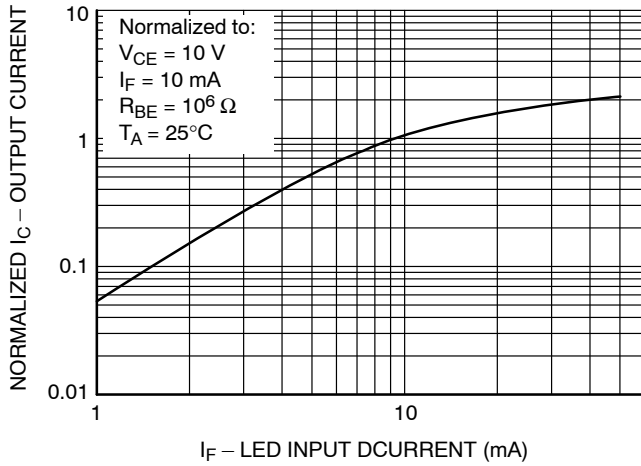

Figure 4. Normalized Output Current vs. LED Input Current

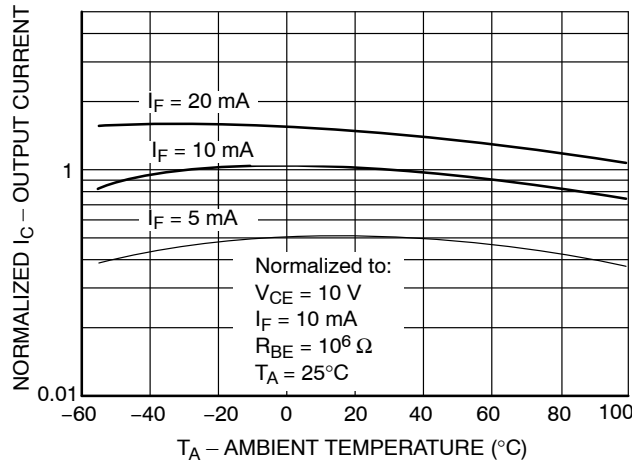

Figure 5. Normalized Output Current vs. Temperature

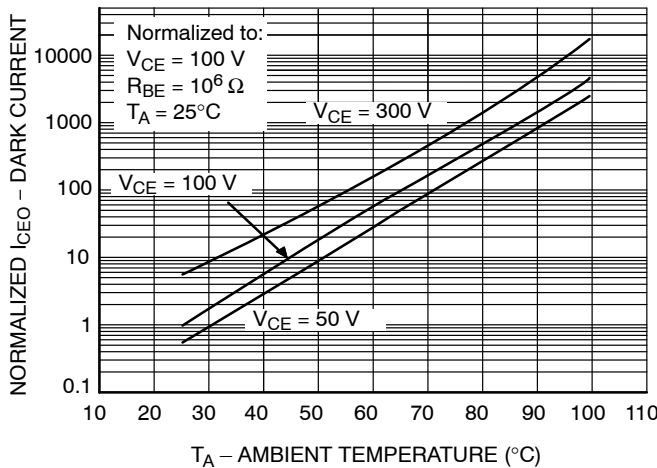

Figure 6. Normalized Dark Current vs. Ambient Temperature

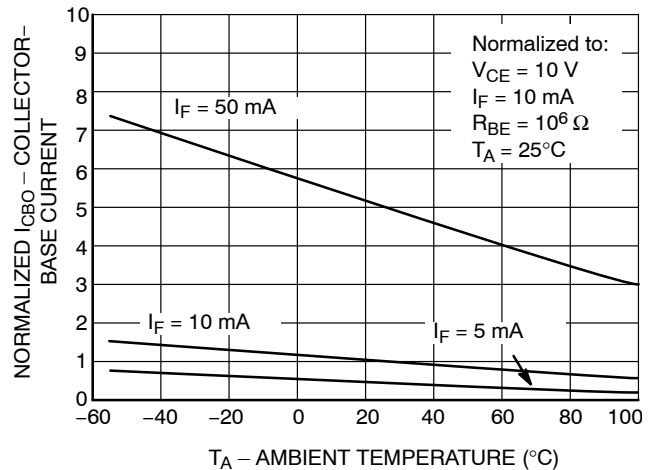

Figure 7. Normalized Collector-Base Current vs. Temperature

REFLOW PROFILE

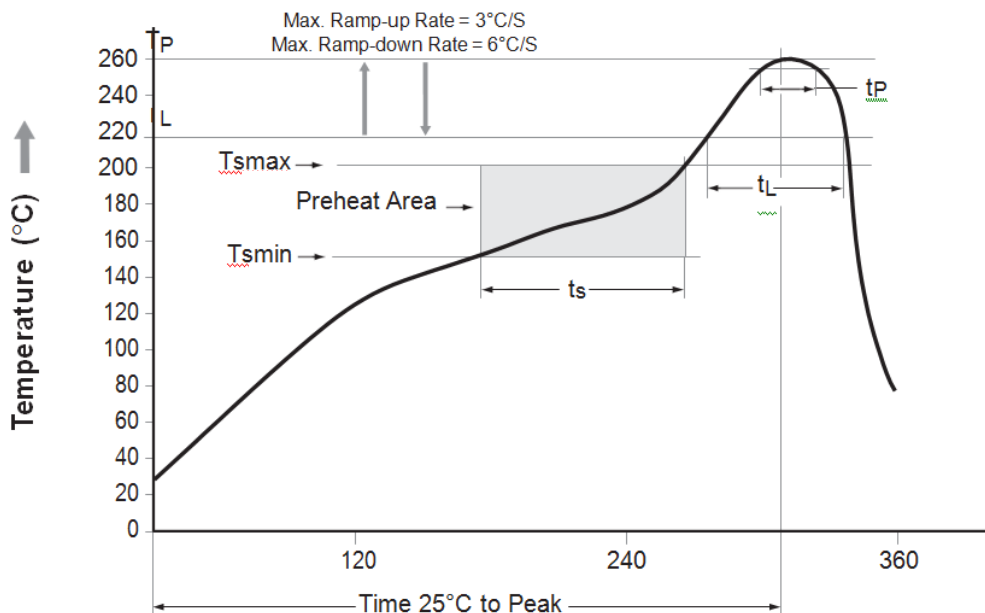

Figure 8. Reflow Profile

Profile Feature	Pb-Free Assembly Profile
Temperature Min. (T Amin)	150°C
Temperature Max. (Tsmax)	200°C
Time (ts) from (T Amin to Tsmax)	60 – 120 seconds
Ramp-up Rate (t to tP)	3°C / second max.
Liquidous Temperature (TL)	217°C
Time (tL) Maintained Above (TL)	60 – 150 seconds
Peak Body Package Temperature	260°C + 0°C / -5°C
Time (tP) within 5°C of 260°C	30 seconds
Ramp-down Rate (TP to TL)	6°C / second max.
Time 25°C to Peak Temperature	8 minutes max.

Table 1. ORDERING INFORMATION

Part Number	Package	Packing Method†
H11D1M	DIP 6-Pin	Tube (50 Units)
H11D1SM	SMT 6-Pin (Lead Bend)	Tube (50 Units)
H11D1SR2M	SMT 6-Pin (Lead Bend)	Tape and Reel (1000 Units)
H11D1VM	DIP 6-Pin, DIN EN/IEC60747-5-5 Option	Tube (50 Units)
H11D1SVM	SMT 6-Pin (Lead Bend), DIN EN/IEC60747-5-5 Option	Tube (50 Units)
H11D1SR2VM	SMT 6-Pin (Lead Bend), DIN EN/IEC60747-5-5 Option	Tape and Reel (1000 Units)
H11D1TVM	DIP 6-Pin, 0.4" Lead Spacing, DIN EN/IEC60747-5-5 Option	Tube (50 Units)

†For information on tape and reel specifications, including part orientation and tape sizes, please refer to our Tape and Reel Packaging Specifications Brochure, BRD8011/D.

4. The product orderable part number system listed in this table also applies to the 4N38M, H11D3M, and MOC8204M devices.

# MECHANICAL CASE OUTLINE

## PACKAGE DIMENSIONS

ON Semiconductor®



PDIP6 8.51x6.35, 2.54P  
CASE 646BX  
ISSUE O

DATE 31 JUL 2016



NOTES:

- A) NO STANDARD APPLIES TO THIS PACKAGE.
- B) ALL DIMENSIONS ARE IN MILLIMETERS.
- C) DIMENSIONS ARE EXCLUSIVE OF BURRS, MOLD FLASH, AND TIE BAR EXTRUSION

<b>DOCUMENT NUMBER:</b>	<b>98AON13449G</b>	Electronic versions are uncontrolled except when accessed directly from the Document Repository. Printed versions are uncontrolled except when stamped "CONTROLLED COPY" in red.
<b>DESCRIPTION:</b>	<b>PDIP6 8.51X6.35, 2.54P</b>	<b>PAGE 1 OF 1</b>

ON Semiconductor and are trademarks of Semiconductor Components Industries, LLC dba ON Semiconductor or its subsidiaries in the United States and/or other countries. ON Semiconductor reserves the right to make changes without further notice to any products herein. ON Semiconductor makes no warranty, representation or guarantee regarding the suitability of its products for any particular purpose, nor does ON Semiconductor assume any liability arising out of the application or use of any product or circuit, and specifically disclaims any and all liability, including without limitation special, consequential or incidental damages. ON Semiconductor does not convey any license under its patent rights nor the rights of others.

# MECHANICAL CASE OUTLINE

## PACKAGE DIMENSIONS

ON Semiconductor®



### PDIP6 8.51x6.35, 2.54P

#### CASE 646BY

#### ISSUE A

DATE 15 JUL 2019



**NOTES:**

1. DIMENSIONING AND TOLERANCING PER ASME Y14.5M, 2009.
2. CONTROLLING DIMENSION: MILLIMETERS
3. DIMENSIONS A, A1, AND L ARE MEASURED WITH THE PACKAGE SEATED.
4. DIMENSIONS D, D1, AND E1 DO NOT INCLUDE MOLD FLASH OR PROTRUSIONS. MOLD FLASH OR PROTRUSIONS ARE NOT TO EXCEED 2.54mm.
5. PACKAGE CONTOUR IS OPTIONAL (ROUNDED OR SQUARE CORNERS).
6. CENTER LINE OF CORNER LEADS ARE LOCATED BY LOCATING THE CENTER OF FEATURE b2 AND b3.

DIM	MILLIMETERS		
	MIN.	NOM.	MAX.
A	---	---	4.80
A1	0.38	---	---
A2	3.28	3.40	3.53
A3	2.49 REF		
A4	1.89 REF		
b	0.41	0.46	0.51
b1	0.76	0.92	1.14
b2	0.25	0.28	0.36
b3	1.02	1.40	1.78
b4	1.778 REF		
c	0.20	0.25	0.30
D	8.13	8.51	8.89
D1	0.86 REF		
E	6.10	6.35	6.60
E1	8.43	9.17	9.90
E2	8.13 REF		
e	2.54 BSC		
L	0.16	0.52	0.88

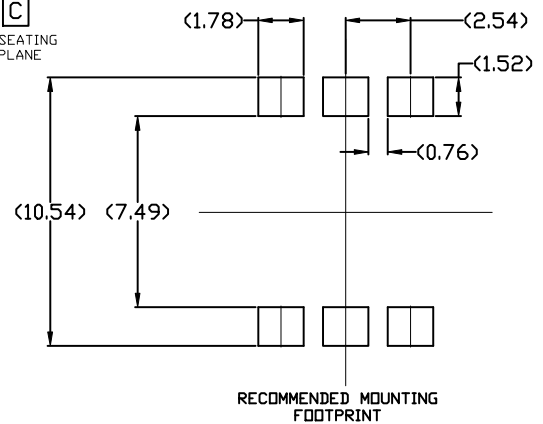
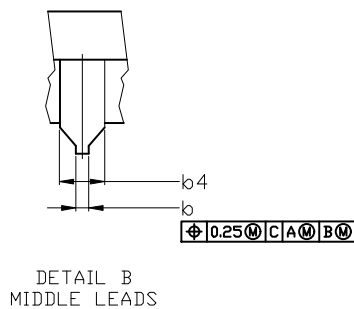
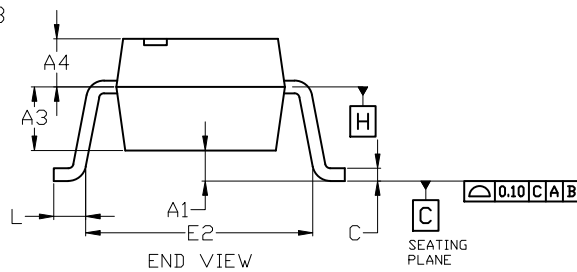

For additional information on our Pb-Free strategy and soldering details, please download the ON Semiconductor Soldering and Mounting Techniques Reference Manual, SOLDERM/D.

<b>DOCUMENT NUMBER:</b>	<b>98AON13450G</b>	Electronic versions are uncontrolled except when accessed directly from the Document Repository. Printed versions are uncontrolled except when stamped "CONTROLLED COPY" in red.
<b>DESCRIPTION:</b>	<b>PDIP6 8.51x6.35, 2.54P</b>	<b>PAGE 1 OF 1</b>

ON Semiconductor and ON are trademarks of Semiconductor Components Industries, LLC dba ON Semiconductor or its subsidiaries in the United States and/or other countries. ON Semiconductor reserves the right to make changes without further notice to any products herein. ON Semiconductor makes no warranty, representation or guarantee regarding the suitability of its products for any particular purpose, nor does ON Semiconductor assume any liability arising out of the application or use of any product or circuit, and specifically disclaims any and all liability, including without limitation special, consequential or incidental damages. ON Semiconductor does not convey any license under its patent rights nor the rights of others.



**MECHANICAL CASE OUTLINE**  
**PACKAGE DIMENSIONS**

ON Semiconductor®



PDIP6 8.51x6.35, 2.54P  
CASE 646BZ  
ISSUE O

DATE 31 JUL 2016

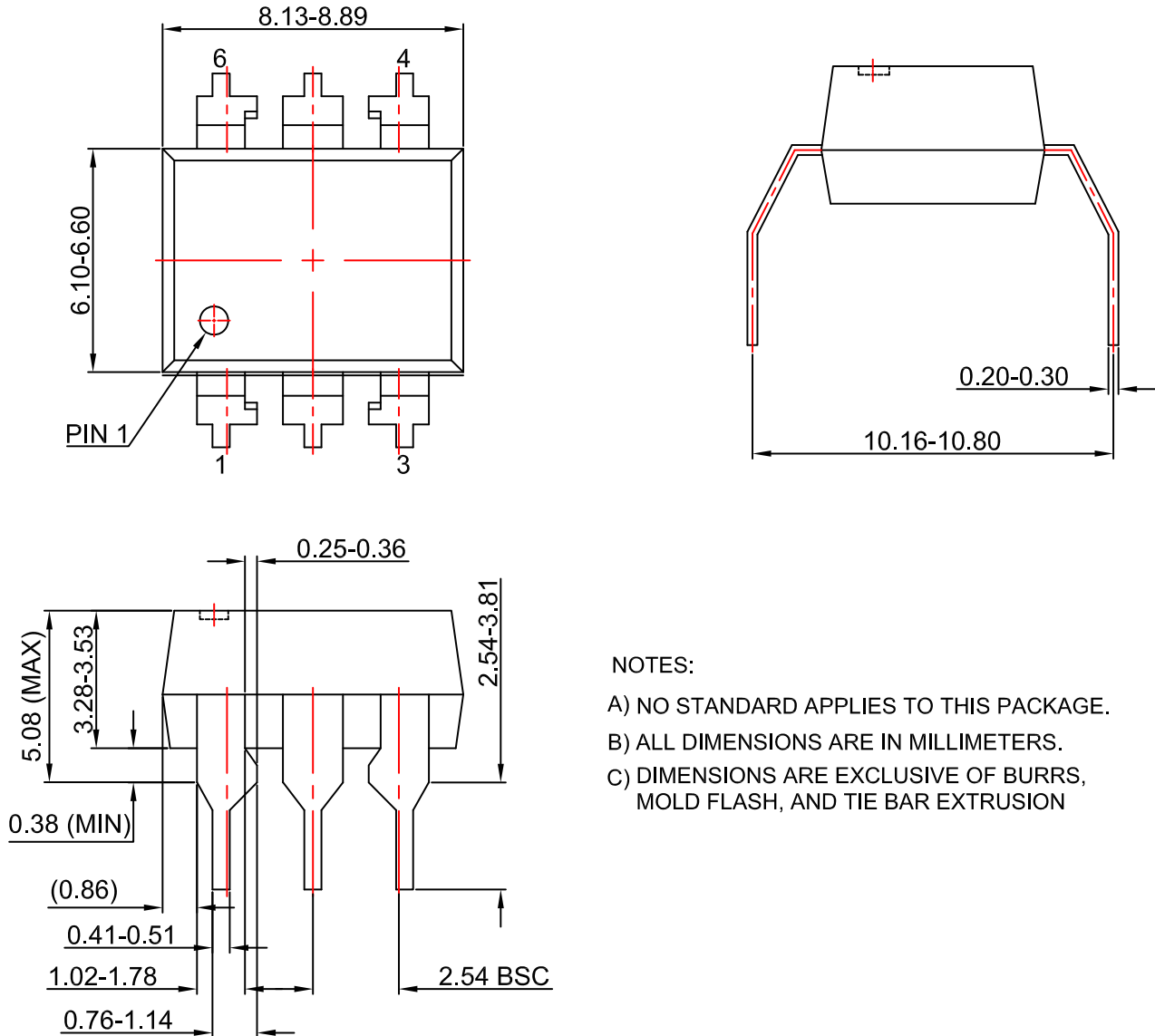

NOTES:

- A) NO STANDARD APPLIES TO THIS PACKAGE.
- B) ALL DIMENSIONS ARE IN MILLIMETERS.
- C) DIMENSIONS ARE EXCLUSIVE OF BURRS, MOLD FLASH, AND TIE BAR EXTRUSION

<b>DOCUMENT NUMBER:</b>	<b>98AON13451G</b>	Electronic versions are uncontrolled except when accessed directly from the Document Repository. Printed versions are uncontrolled except when stamped "CONTROLLED COPY" in red.
<b>DESCRIPTION:</b>	<b>PDIP6 8.51X6.35, 2.54P</b>	<b>PAGE 1 OF 1</b>

ON Semiconductor and are trademarks of Semiconductor Components Industries, LLC dba ON Semiconductor or its subsidiaries in the United States and/or other countries. ON Semiconductor reserves the right to make changes without further notice to any products herein. ON Semiconductor makes no warranty, representation or guarantee regarding the suitability of its products for any particular purpose, nor does ON Semiconductor assume any liability arising out of the application or use of any product or circuit, and specifically disclaims any and all liability, including without limitation special, consequential or incidental damages. ON Semiconductor does not convey any license under its patent rights nor the rights of others.

**onsemi**, **Onsemi**, and other names, marks, and brands are registered and/or common law trademarks of Semiconductor Components Industries, LLC dba "**onsemi**" or its affiliates and/or subsidiaries in the United States and/or other countries. **onsemi** owns the rights to a number of patents, trademarks, copyrights, trade secrets, and other intellectual property. A listing of **onsemi**'s product/patent coverage may be accessed at [www.onsemi.com/site/pdf/Patent-Marking.pdf](http://www.onsemi.com/site/pdf/Patent-Marking.pdf). **onsemi** reserves the right to make changes at any time to any products or information herein, without notice. The information herein is provided "as-is" and **onsemi** makes no warranty, representation or guarantee regarding the accuracy of the information, product features, availability, functionality, or suitability of its products for any particular purpose, nor does **onsemi** assume any liability arising out of the application or use of any product or circuit, and specifically disclaims any and all liability, including without limitation special, consequential or incidental damages. Buyer is responsible for its products and applications using **onsemi** products, including compliance with all laws, regulations and safety requirements or standards, regardless of any support or applications information provided by **onsemi**. "Typical" parameters which may be provided in **onsemi** data sheets and/or specifications can and do vary in different applications and actual performance may vary over time. All operating parameters, including "Typicals" must be validated for each customer application by customer's technical experts. **onsemi** does not convey any license under any of its intellectual property rights nor the rights of others. **onsemi** products are not designed, intended, or authorized for use as a critical component in life support systems or any FDA Class 3 medical devices or medical devices with a same or similar classification in a foreign jurisdiction or any devices intended for implantation in the human body. Should Buyer purchase or use **onsemi** products for any such unintended or unauthorized application, Buyer shall indemnify and hold **onsemi** and its officers, employees, subsidiaries, affiliates, and distributors harmless against all claims, costs, damages, and expenses, and reasonable attorney fees arising out of, directly or indirectly, any claim of personal injury or death associated with such unintended or unauthorized use, even if such claim alleges that **onsemi** was negligent regarding the design or manufacture of the part. **onsemi** is an Equal Opportunity/Affirmative Action Employer. This literature is subject to all applicable copyright laws and is not for resale in any manner.

## ADDITIONAL INFORMATION

### TECHNICAL PUBLICATIONS:

Technical Library: [www.onsemi.com/design/resources/technical-documentation](http://www.onsemi.com/design/resources/technical-documentation)  
onsemi Website: [www.onsemi.com](http://www.onsemi.com)

### ONLINE SUPPORT: [www.onsemi.com/support](http://www.onsemi.com/support)

For additional information, please contact your local Sales Representative at [www.onsemi.com/support/sales](http://www.onsemi.com/support/sales)

