

# MOSFET – N-Channel, POWERTRENCH®

**30 V, 16 A, 14.3 mohm**

## FDMC8882

### Description

This N-Channel MOSFET is produced using **onsemi**'s advanced POWETRENCH process that has been especially tailored to minimize the on-state resistance. This device is well suited for Power Management and load switching applications common in Notebook Computers and Portable Battery Packs.

### Features

- Max  $R_{DS(on)}$  = 14.3 mΩ at  $V_{GS} = 10\text{ V}$ ,  $I_D = 10.5\text{ A}$
- Max  $R_{DS(on)}$  = 22.5 mΩ at  $V_{GS} = 4.5\text{ V}$ ,  $I_D = 8.3\text{ A}$
- High Performance Technology for Extremely Low  $R_{DS(on)}$
- Termination is Lead-Free
- RoHS Compliant

### Applications

- High Side in DC-DC Buck Converters
- Notebook Battery Power Management
- Load Switch in Notebook

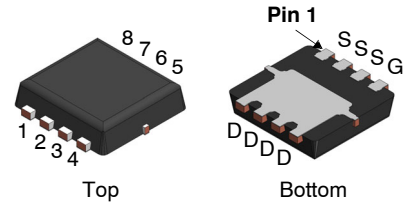

WDFN8 3.3x3.3, 0.65P  
 CASE 511DR

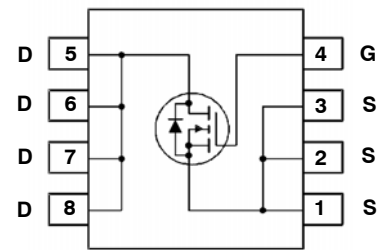

### MARKING DIAGRAM

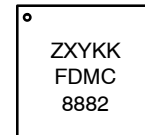

- Z = Assembly Plant Code
- XY = Date Code (Year & Week)
- KK = Lot Traceability Code
- FDMC8882 = Specific Device Code

### ORDERING INFORMATION

| Device   | Package            | Shipping†             |
|----------|--------------------|-----------------------|
| FDMC8882 | WDFN8<br>(Pb-Free) | 3000 /<br>Tape & Reel |

†For information on tape and reel specifications, including part orientation and tape sizes, please refer to our Tape and Reel Packaging Specification Brochure, [BRD8011/D](#).

# FDMC8882

## MOSFET MAXIMUM RATINGS ( $T_A = 25^\circ\text{C}$ unless otherwise noted)

| Symbol         | Parameter  |                              | Ratings                               | Unit             |   |
|----------------|--|------------------------------|---------------------------------------|------------------|---|
| $V_{DS}$       | Drain to Source Voltage                          |                              | 30                                    | V                |   |
| $V_{GS}$       | Gate to Source Voltage                           |                              | $\pm 20$                              | V                |   |
| $I_D$          | Drain Current                                    | Continuous (Package Limited) | $T_C = 25^\circ\text{C}$              | 16               | A |
|                |  | Continuous (Silicon Limited) | $T_C = 25^\circ\text{C}$              | 34               |   |
|                |  | Continuous                   | $T_A = 25^\circ\text{C}$<br>(Note 1a) | 10.5             | A |
|                |  | Pulsed                       | -                                     | 40               |   |
| $P_D$          | Power Dissipation                                |                              | $T_C = 25^\circ\text{C}$              | 18               | W |
|                | Power Dissipation                                |                              | $T_A = 25^\circ\text{C}$<br>(Note 1a) | 2.3              |   |
| $T_J, T_{STG}$ | Operating and Storage Junction Temperature Range |                              | -55 to +150                           | $^\circ\text{C}$ |   |

Stresses exceeding those listed in the Maximum Ratings table may damage the device. If any of these limits are exceeded, device functionality should not be assumed, damage may occur and reliability may be affected.

## THERMAL CHARACTERISTICS

| Symbol          | Parameter   | Ratings | Unit                      |
|-----------------|---|---------|---------------------------|
| $R_{\theta JC}$ | Thermal Resistance, Junction-to-Case              | 6.6     | $^\circ\text{C}/\text{W}$ |
| $R_{\theta JA}$ | Thermal Resistance, Junction-to-Ambient (Note 1a) | 53      |                           |

## ELECTRICAL CHARACTERISTICS ( $T_J = 25^\circ\text{C}$ unless otherwise noted)

| Symbol | Parameter | Test Conditions | Min | Typ | Max | Unit |
|--------|-----------|-----------------|-----|-----|-----|------|
|--------|-----------|-----------------|-----|-----|-----|------|

### OFF CHARACTERISTICS

|                                      |   |  |    |    |           |                            |
|--------------------------------------|---|--|----|----|-----------|----------------------------|
| $BV_{DSS}$                           | Drain-to-Source Breakdown Voltage         | $I_D = 250 \mu\text{A}, V_{GS} = 0 \text{ V}$                          | 30 | -  | -         | V                          |
| $\frac{\Delta BV_{DSS}}{\Delta T_J}$ | Breakdown Voltage Temperature Coefficient | $I_D = 250 \mu\text{A}$ , referenced to $25^\circ\text{C}$             | -  | 25 | -         | $\text{mV}/^\circ\text{C}$ |
| $I_{DSS}$                            | Zero Gate Voltage Drain Current           | $V_{DS} = 24 \text{ V}, V_{GS} = 0 \text{ V}$                          | -  | -  | 1         | $\mu\text{A}$              |
|                                      |   | $V_{DS} = 24 \text{ V}, V_{GS} = 0 \text{ V}, T_J = 125^\circ\text{C}$ | -  | -  | 250       |                            |
| $I_{GSS}$                            | Gate-to-Source Leakage Current            | $V_{GS} = \pm 20 \text{ V}, V_{DS} = 0 \text{ V}$                      | -  | -  | $\pm 100$ | nA                         |

### ON CHARACTERISTICS

|  |  |  |     |      |      |                            |
|--|--|--|-----|------|------|----------------------------|
| $V_{GS(th)}$                           | Gate-to-Source Threshold Voltage                         | $V_{GS} = V_{DS}, I_D = 250 \mu\text{A}$                               | 1.2 | 1.9  | 2.5  | V                          |
| $\frac{\Delta V_{GS(th)}}{\Delta T_J}$ | Gate-to-Source Threshold Voltage Temperature Coefficient | $I_D = 250 \mu\text{A}$ , referenced to $25^\circ\text{C}$             | -   | -5   | -    | $\text{mV}/^\circ\text{C}$ |
| $R_{DS(on)}$                           | Static Drain-to-Source On Resistance                     | $V_{GS} = 10 \text{ V}, I_D = 10.5 \text{ A}$                          | -   | 12.4 | 14.3 | $\text{m}\Omega$           |
|  |  | $V_{GS} = 4.5 \text{ V}, I_D = 8.3 \text{ A}$                          | -   | 16.0 | 22.5 |                            |
|  |  | $V_{GS} = 10 \text{ V}, I_D = 10.5 \text{ A}, T_J = 125^\circ\text{C}$ | -   | 17.4 | -    |                            |
| $g_{FS}$                               | Forward Transconductance                                 | $V_{DS} = 5 \text{ V}, I_D = 10.5 \text{ A}$                           | -   | 33   | -    | S                          |

### DYNAMIC CHARACTERISTICS

|           |                              |  |   |     |     |             |
|-----------|------------------------------|--|---|-----|-----|-------------|
| $C_{iss}$ | Input Capacitance            | $V_{DS} = 15 \text{ V}, V_{GS} = 0 \text{ V}, f = 1 \text{ MHz}$ | - | 710 | 945 | $\text{pF}$ |
| $C_{oss}$ | Output Capacitance           |  | - | 140 | 185 | $\text{pF}$ |
| $C_{rss}$ | Reverse Transfer Capacitance |  | - | 90  | 135 | $\text{pF}$ |
| $R_g$     | Gate Resistance              |  | - | 1.0 | -   | $\Omega$    |

# FDMC8882

## ELECTRICAL CHARACTERISTICS ( $T_J = 25^\circ\text{C}$ unless otherwise noted)

| Symbol                           | Parameter                     | Test Conditions  | Min | Typ | Max | Unit |
|----------------------------------|-------------------------------|--|-----|-----|-----|------|
| <b>SWITCHING CHARACTERISTICS</b> |                               |  |     |     |     |      |
| $t_{d(on)}$                      | Turn-On Delay Time            | $V_{DD} = 15\text{ V}$ , $I_D = 10.5\text{ A}$ , $V_{GS} = 10\text{ V}$ ,<br>$R_{GEN} = 6\ \Omega$ | –   | 7   | 14  | ns   |
| $t_r$                            | Rise Time                     |  | –   | 3   | 10  |      |
| $t_{d(off)}$                     | Turn-Off Delay Time           |  | –   | 17  | 30  |      |
| $t_f$                            | Fall Time                     |  | –   | 2   | 10  |      |
| $Q_{g(tot)}$                     | Total Gate Charge             | $V_{GS} = 0\text{ V to }10\text{ V}$ , $V_{DD} = 15\text{ V}$ , $I_D = 10.5\text{ A}$              | –   | 14  | 20  | nC   |
|                                  | Total Gate Charge             | $V_{GS} = 0\text{ V to }4.5\text{ V}$ , $V_{DD} = 15\text{ V}$ , $I_D = 10.5\text{ A}$             | –   | 7   | 10  |      |
| $Q_{gs}$                         | Gate-to-Source Charge         | $V_{DD} = 15\text{ V}$ , $I_D = 10.5\text{ A}$   | –   | 2.3 | –   |      |
| $Q_{gd}$                         | Gate-to-Drain “Miller” Charge | $V_{DD} = 15\text{ V}$ , $I_D = 10.5\text{ A}$   | –   | 2.8 | –   |      |

## DRAIN-SOURCE DIODE CHARACTERISTICS

|          |                                       |  |   |      |     |    |
|----------|---------------------------------------|--|---|------|-----|----|
| $V_{SD}$ | Source-to-Drain Diode Forward Voltage | $V_{GS} = 0\text{ V}$ , $I_S = 10.5\text{ A}$ (Note 2)     | – | 0.88 | 1.2 | V  |
|          |                                       | $V_{GS} = 0\text{ V}$ , $I_S = 1.9\text{ A}$ (Note 2)      | – | 0.76 | 1.2 |    |
| $t_{rr}$ | Reverse Recovery Time                 | $I_F = 10.5\text{ A}$ , $di/dt = 100\text{ A}/\mu\text{s}$ | – | 16   | 28  | ns |
| $Q_{rr}$ | Reverse Recovery Charge               |  | – | 4.4  | 10  | nC |

Product parametric performance is indicated in the Electrical Characteristics for the listed test conditions, unless otherwise noted. Product performance may not be indicated by the Electrical Characteristics if operated under different conditions.

### NOTES:

- $R_{\theta JA}$  is determined with the device mounted on a 1 in<sup>2</sup> pad 2 oz copper pad on a 1.5 × 1.5 in. board of FR-4 material.  $R_{\theta JC}$  is guaranteed by design while  $R_{\theta CA}$  is determined by the user's board design.

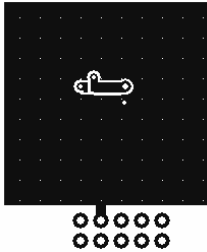

- 53°C/W when mounted on a 1 in<sup>2</sup> pad of 2 oz copper



- 125°C/W when mounted on a minimum pad of 2 oz copper

- Pulse Test: Pulse Width < 300  $\mu\text{s}$ , Duty cycle < 2.0%.

TYPICAL CHARACTERISTICS

( $T_J = 25^\circ\text{C}$  unless otherwise noted)

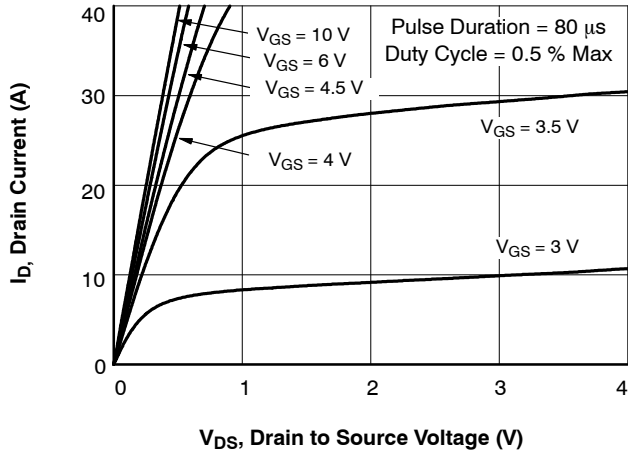

Figure 1. On-Region Characteristics

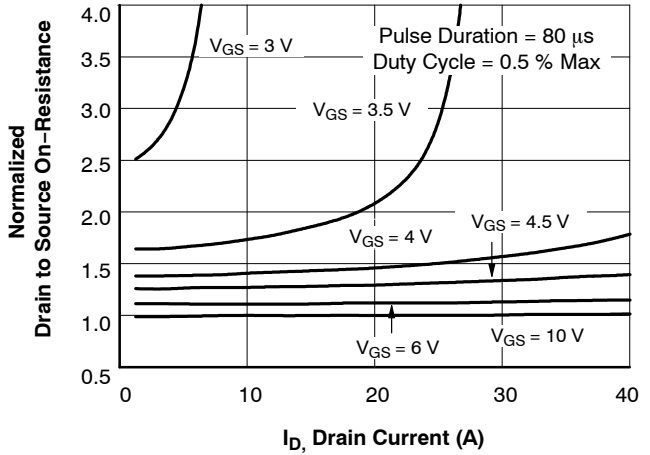

Figure 2. Normalized On-Resistance vs. Drain Current and Gate Voltage

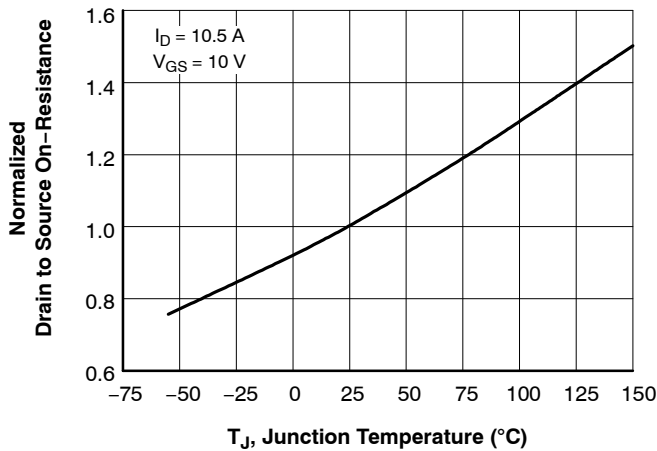

Figure 3. Normalized On-Resistance vs. Junction Temperature

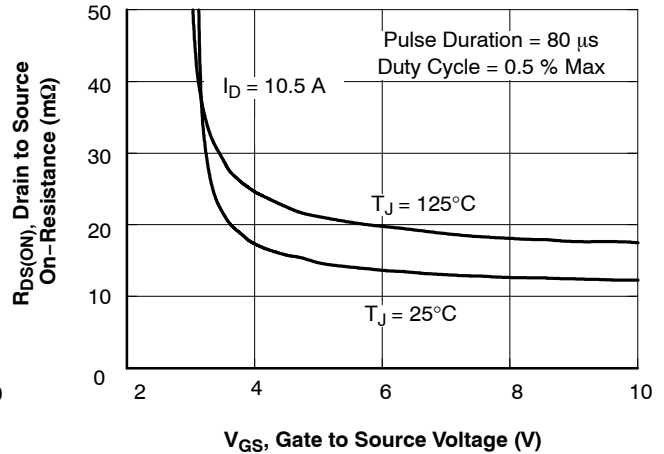

Figure 4. On-Resistance vs. Gate to Source Voltage

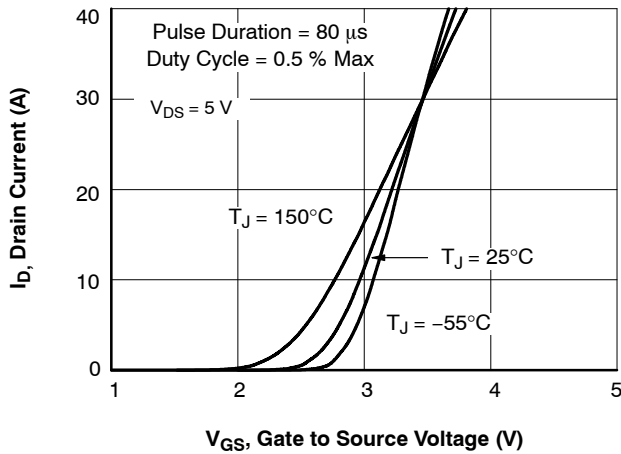

Figure 5. Transfer Characteristics

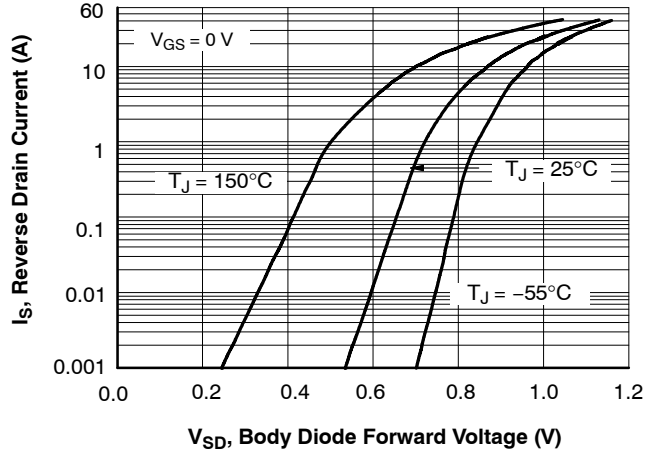

Figure 6. Source to Drain Diode Forward Voltage vs. Source Current

TYPICAL CHARACTERISTICS (continued)

( $T_J = 25^\circ\text{C}$  unless otherwise noted)

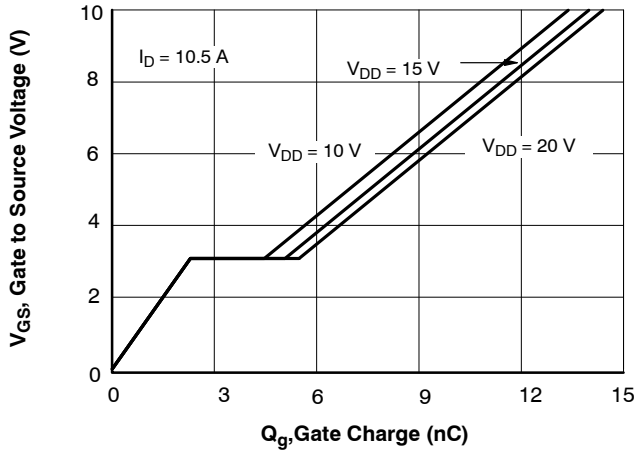

Figure 7. Gate Charge Characteristics

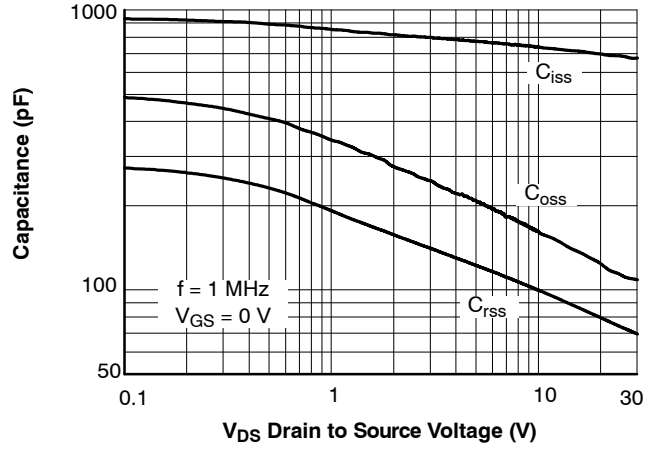

Figure 8. Capacitance vs Drain to Source Voltage

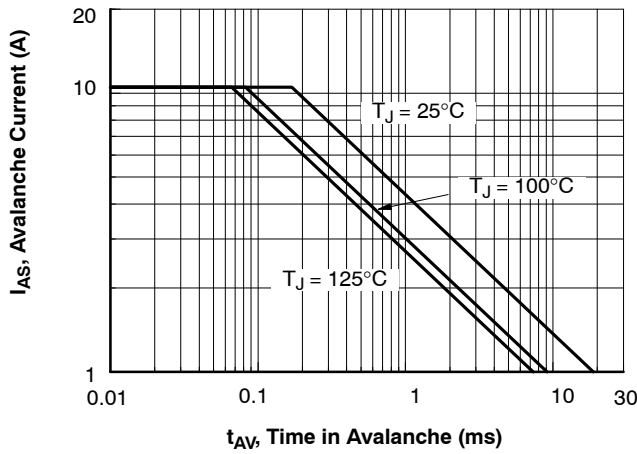

Figure 9. Unclamped Inductive Switching Capability

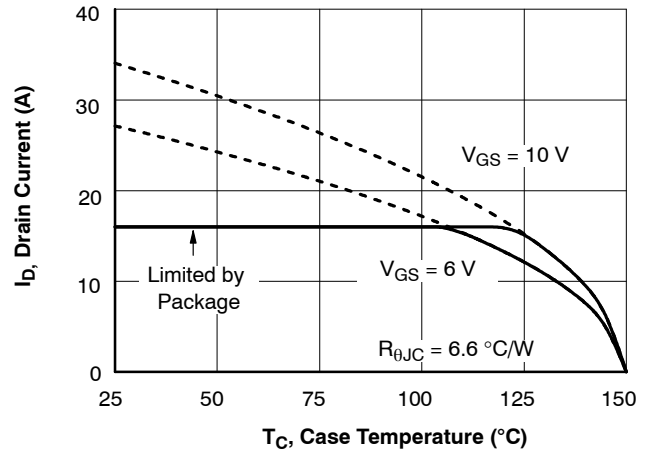

Figure 10. Maximum Continuous Drain Current vs. Case Temperature

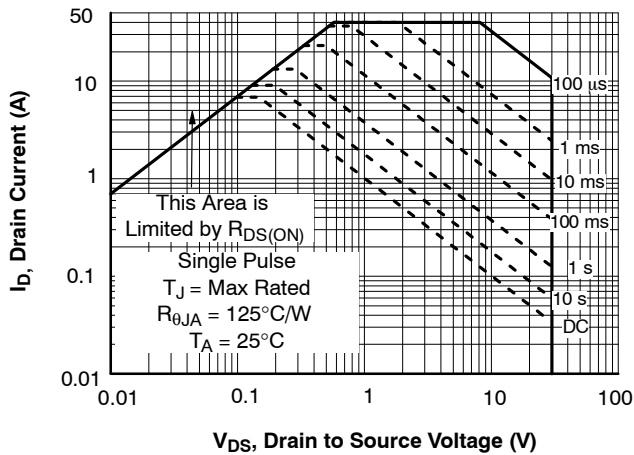

Figure 11. Forward Bias Safe Operating Area

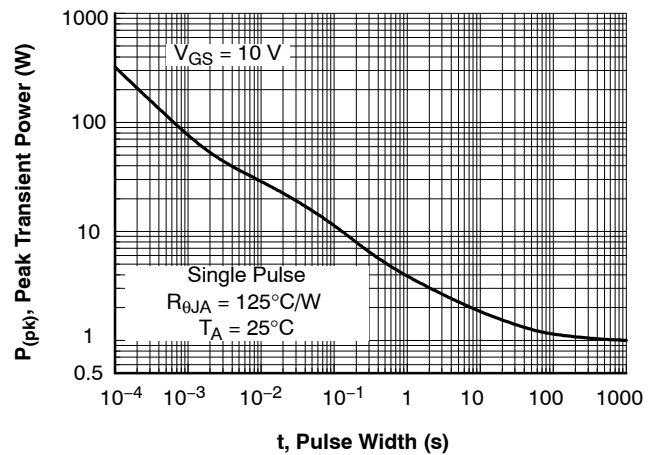

Figure 12. Single Pulse Maximum Power Dissipation

TYPICAL CHARACTERISTICS (continued)

( $T_J = 25^\circ\text{C}$  unless otherwise noted)

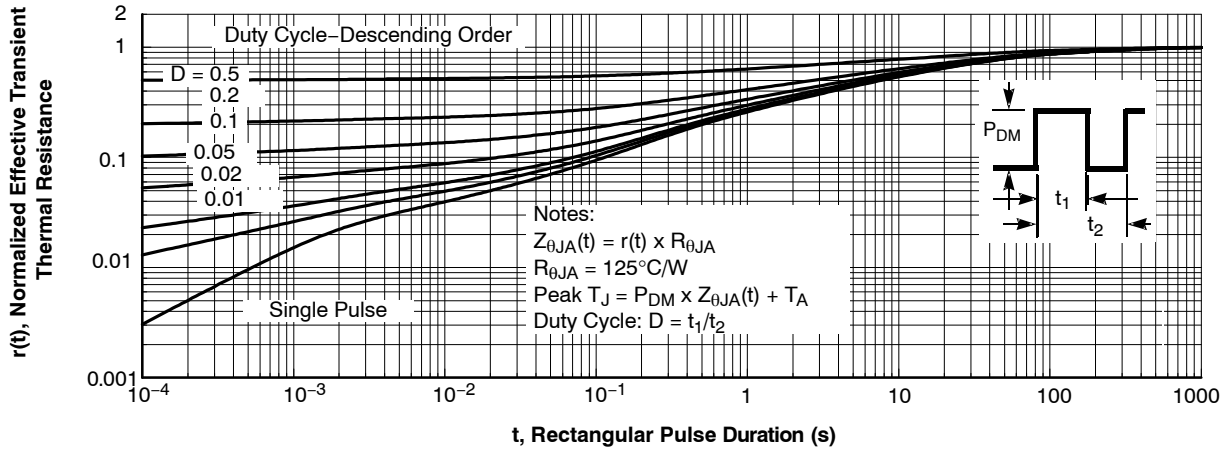
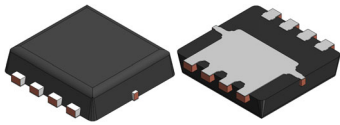

Figure 13. Transient Thermal Response Curve

# MECHANICAL CASE OUTLINE PACKAGE DIMENSIONS



**WDFN8 3.3x3.3, 0.65P**  
CASE 511DR  
ISSUE B

DATE 02 FEB 2022

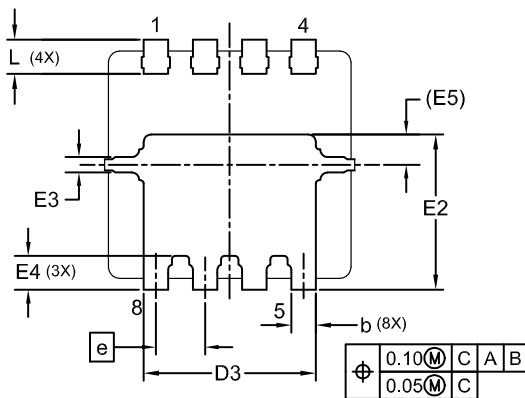
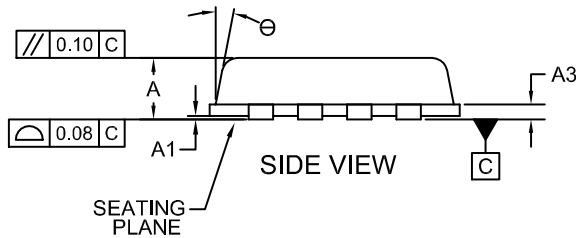
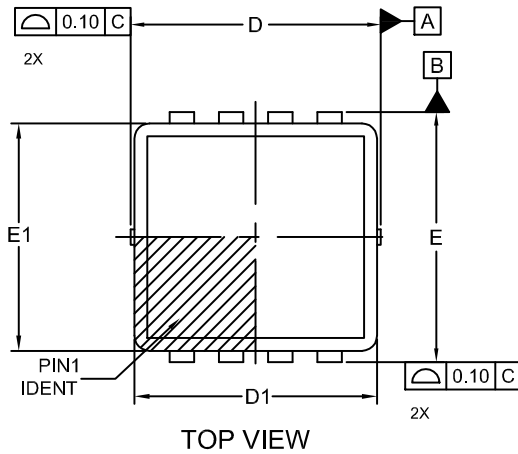

| DIM | MILLIMETERS |      |      |
|-----|-------------|------|------|
|     | MIN         | NOM  | MAX  |
| A   | 0.70        | 0.75 | 0.80 |
| A1  | 0.00        | -    | 0.05 |
| A3  | 0.15        | 0.20 | 0.25 |
| b   | 0.27        | 0.32 | 0.37 |
| D   | 3.20        | 3.30 | 3.40 |
| D1  | 3.10        | 3.20 | 3.30 |
| D3  | 2.17        | 2.27 | 2.37 |
| E   | 3.20        | 3.30 | 3.40 |
| E1  | 2.90        | 3.00 | 3.10 |
| E2  | 1.95        | 2.05 | 2.15 |
| E3  | 0.15        | 0.20 | 0.25 |
| E4  | 0.30        | 0.40 | 0.50 |
| E5  | 0.40 REF    |      |      |
| e   | 0.65 BSC    |      |      |
| L   | 0.30        | 0.40 | 0.50 |
| Θ   | 0°          | -    | 12°  |

**NOTES:**

- A. DIMENSIONS AND TOLERANCES PER ASME Y14.5M, 2009.
- B. SEATING PLANE IS DEFINED BY TERMINAL TIPS ONLY
- C. BODY DIMENSIONS DO NOT INCLUDE MOLD FLASH PROTRUSIONS NOR GATE BURRS. MOLD FLASH PROTRUSION OR GATE BURR DOES NOT EXCEED 0.150MM.

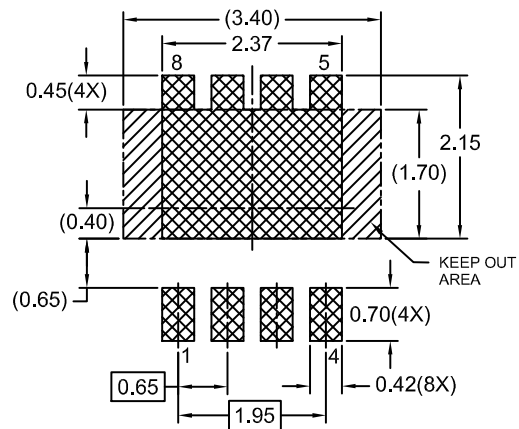

**RECOMMENDED LAND PATTERN**

\*FOR ADDITIONAL INFORMATION ON OUR PB-FREE STRATEGY AND SOLDERING DETAILS, PLEASE DOWNLOAD THE ON SEMICONDUCTOR SOLDERING AND MOUNTING TECHNIQUES REFERENCE MANUAL, SOLDERRM/D.

**GENERIC MARKING DIAGRAM\***

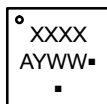

- XXXX = Specific Device Code
- A = Assembly Location
- Y = Year
- WW = Work Week
- = Pb-Free Package

\*This information is generic. Please refer to device data sheet for actual part marking. Pb-Free indicator, "G" or microdot "▪", may or may not be present. Some products may not follow the Generic Marking.

(Note: Microdot may be in either location)

|                         |                             |  |
|-------------------------|-----------------------------|--|
| <b>DOCUMENT NUMBER:</b> | <b>98AON13650G</b>          | Electronic versions are uncontrolled except when accessed directly from the Document Repository. Printed versions are uncontrolled except when stamped "CONTROLLED COPY" in red. |
| <b>DESCRIPTION:</b>     | <b>WDFN8 3.3x3.3, 0.65P</b> | <b>PAGE 1 OF 1</b>   |

onsemi and ONSEMI are trademarks of Semiconductor Components Industries, LLC dba onsemi or its subsidiaries in the United States and/or other countries. onsemi reserves the right to make changes without further notice to any products herein. onsemi makes no warranty, representation or guarantee regarding the suitability of its products for any particular purpose, nor does onsemi assume any liability arising out of the application or use of any product or circuit, and specifically disclaims any and all liability, including without limitation special, consequential or incidental damages. onsemi does not convey any license under its patent rights nor the rights of others.

**onsemi**, **Onsemi**, and other names, marks, and brands are registered and/or common law trademarks of Semiconductor Components Industries, LLC dba "**onsemi**" or its affiliates and/or subsidiaries in the United States and/or other countries. **onsemi** owns the rights to a number of patents, trademarks, copyrights, trade secrets, and other intellectual property. A listing of **onsemi**'s product/patent coverage may be accessed at [www.onsemi.com/site/pdf/Patent-Marking.pdf](http://www.onsemi.com/site/pdf/Patent-Marking.pdf). **onsemi** reserves the right to make changes at any time to any products or information herein, without notice. The information herein is provided "as-is" and **onsemi** makes no warranty, representation or guarantee regarding the accuracy of the information, product features, availability, functionality, or suitability of its products for any particular purpose, nor does **onsemi** assume any liability arising out of the application or use of any product or circuit, and specifically disclaims any and all liability, including without limitation special, consequential or incidental damages. Buyer is responsible for its products and applications using **onsemi** products, including compliance with all laws, regulations and safety requirements or standards, regardless of any support or applications information provided by **onsemi**. "Typical" parameters which may be provided in **onsemi** data sheets and/or specifications can and do vary in different applications and actual performance may vary over time. All operating parameters, including "Typicals" must be validated for each customer application by customer's technical experts. **onsemi** does not convey any license under any of its intellectual property rights nor the rights of others. **onsemi** products are not designed, intended, or authorized for use as a critical component in life support systems or any FDA Class 3 medical devices or medical devices with a same or similar classification in a foreign jurisdiction or any devices intended for implantation in the human body. Should Buyer purchase or use **onsemi** products for any such unintended or unauthorized application, Buyer shall indemnify and hold **onsemi** and its officers, employees, subsidiaries, affiliates, and distributors harmless against all claims, costs, damages, and expenses, and reasonable attorney fees arising out of, directly or indirectly, any claim of personal injury or death associated with such unintended or unauthorized use, even if such claim alleges that **onsemi** was negligent regarding the design or manufacture of the part. **onsemi** is an Equal Opportunity/Affirmative Action Employer. This literature is subject to all applicable copyright laws and is not for resale in any manner.

## PUBLICATION ORDERING INFORMATION

### LITERATURE FULFILLMENT:

Email Requests to: [orderlit@onsemi.com](mailto:orderlit@onsemi.com)

**onsemi Website:** [www.onsemi.com](http://www.onsemi.com)

### TECHNICAL SUPPORT

**North American Technical Support:**

Voice Mail: 1 800-282-9855 Toll Free USA/Canada

Phone: 011 421 33 790 2910

**Europe, Middle East and Africa Technical Support:**

Phone: 00421 33 790 2910

For additional information, please contact your local Sales Representative