

# MOSFET – N-Channel, POWERTRENCH®

**150 V, 130 A, 7.5 mΩ**

## FDP075N15A, FDB075N15A

### Description

This N-Channel MOSFET is produced using onsemi advanced POWERTRENCH process that has been tailored to minimize the on-state resistance while maintaining superior switching performance.

### Features

- $R_{DS(on)} = 6.25 \text{ m}\Omega$  (Typ.) @  $V_{GS} = 10 \text{ V}$ ,  $I_D = 100 \text{ A}$
- Fast Switching
- Low Gate Charge
- High Performance Trench Technology for Extremely Low  $R_{DS(on)}$
- High Power and Current Handling Capability
- RoHS Compliant

### Applications

- Synchronous Rectification for ATX / Server / Telecom PSU
- Battery Protection Circuit
- Motor Drives and Uninterruptible Power Supplies
- Micro Solar Inverter

$V_{DSS}$	$R_{DS(ON)}$ MAX	$I_D$ MAX
150 V	7.5 mΩ @ 10 V	130 A

\*Package limitation current is 120 A.

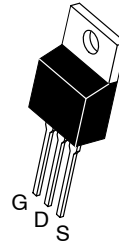

TO-220  
CASE 221A-09

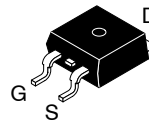

D<sup>2</sup>PAK-3 (TO-263, 3-LEAD)  
CASE 418AJ

### MARKING DIAGRAM

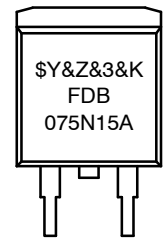
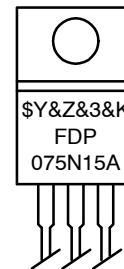

\$Y = onsemi logo  
 FDP075N15A = Device Code  
 FDB075N15A  
 &Z = Assembly Plant Code  
 &3 = 3-Digit Date Code Format  
 &K = 2-Digits Lot Run Traceability Code

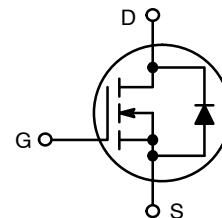

N-Channel

### ORDERING INFORMATION

See detailed ordering and shipping information on page 9 of this data sheet.

## FDP075N15A, FDB075N15A

### MOSFET MAXIMUM RATINGS ( $T_C = 25^\circ\text{C}$ unless otherwise noted)

Symbol	Parameter		FDP075N15A-F102 FDB075N15A	Unit
$V_{DSS}$	Drain to Source Voltage		150	V
$V_{GSS}$	Gate to Source Voltage	- DC	$\pm 20$	V
		- AC ( $f > 1$ Hz)	$\pm 30$	
$I_D$	Drain Current	- Continuous ( $T_C = 25^\circ\text{C}$ )	130*	A
		- Continuous ( $T_C = 100^\circ\text{C}$ )	92	
$I_{DM}$	Drain Current	- Pulsed (Note 1)	522	A
$E_{AS}$	Single Pulsed Avalanche Energy (Note 2)		588	mJ
dv/dt	Peak Diode Recovery dv/dt (Note 3)		6.0	V/ns
$P_D$	Power Dissipation	( $T_C = 25^\circ\text{C}$ )	333	W
		- Derate Above $25^\circ\text{C}$	2.22	
$T_J, T_{STG}$	Operating and Storage Temperature Range		-55 to +175	$^\circ\text{C}$
$T_L$	Maximum Lead Temperature for Soldering, 1/8" from Case for 5 Seconds		300	$^\circ\text{C}$

Stresses exceeding those listed in the Maximum Ratings table may damage the device. If any of these limits are exceeded, device functionality should not be assumed, damage may occur and reliability may be affected.

\*Package limitation current is 120 A.

1. Repetitive rating: pulse-width limited by maximum junction temperature.

2. Starting  $T_J = 25^\circ\text{C}$ ,  $L = 3$  mH,  $I_{AS} = 19.8$  A.

3.  $I_{SD} \leq 100$  A,  $di/dt \leq 200$  A/ $\mu\text{s}$ ,  $V_{DD} \leq BV_{DSS}$ , starting  $T_J = 25^\circ\text{C}$ .

### THERMAL CHARACTERISTICS

Symbol	Parameter	FDP075N15A-F102 FDB075N15A	Unit
$R_{\theta JC}$	Thermal Resistance, Junction to Case, Max.	0.45	$^\circ\text{C}/\text{W}$
$R_{\theta JA}$	Thermal Resistance, Junction to Ambient (Minimum Pad of 2-oz Copper), Max.	62.5	
	Thermal Resistance, Junction to Ambient, D2-PAK (1 in <sup>2</sup> Pad of 2-oz Copper), Max.	40	

# FDP075N15A, FDB075N15A

## ELECTRICAL CHARACTERISTICS (T<sub>C</sub> = 25°C unless otherwise noted)

Symbol	Parameter	Test Conditions	Min	Typ	Max	Unit
--------	-----------	-----------------	-----	-----	-----	------

### OFF CHARACTERISTICS

B <sub>V</sub> DSS	Drain to Source Breakdown Voltage	I <sub>D</sub> = 250 μA, V <sub>GS</sub> = 0 V	150	–	–	V
ΔB <sub>V</sub> DSS / ΔT <sub>J</sub>	Breakdown Voltage Temperature Coefficient	I <sub>D</sub> = 250 μA, Referenced to 25°C	–	0.1	–	V/°C
I <sub>DSS</sub>	Zero Gate Voltage Drain Current	V <sub>DS</sub> = 120 V, V <sub>GS</sub> = 0 V	–	–	1	μA
		V <sub>DS</sub> = 120 V, T <sub>C</sub> = 150°C	–	–	500	
I <sub>GSS</sub>	Gate to Body Leakage Current	V <sub>GS</sub> = ±20 V, V <sub>DS</sub> = 0 V	–	–	±100	nA

### ON CHARACTERISTICS

V <sub>GS(th)</sub>	Gate Threshold Voltage	V <sub>GS</sub> = V <sub>DS</sub> , I <sub>D</sub> = 250 μA	2.0	–	4.0	V
R <sub>DS(on)</sub>	Static Drain to Source On Resistance	V <sub>GS</sub> = 10 V, I <sub>D</sub> = 100 A	–	6.25	7.5	mΩ
g <sub>FS</sub>	Forward Transconductance	V <sub>DS</sub> = 10 V, I <sub>D</sub> = 100 A	–	164	–	S

### DYNAMIC CHARACTERISTICS

C <sub>iss</sub>	Input Capacitance	V <sub>DS</sub> = 75 V, V <sub>GS</sub> = 0 V, f = 1 MHz	–	5525	7350	pF
C <sub>oss</sub>	Output Capacitance		–	516	685	pF
C <sub>rss</sub>	Reverse Transfer Capacitance		–	21	–	pF
C <sub>oss(er)</sub>	Energy Related Output Capacitance	V <sub>DS</sub> = 75 V, V <sub>GS</sub> = 0 V	–	909	–	pF
Q <sub>g(tot)</sub>	Total Gate Charge at 10 V	V <sub>DS</sub> = 75 V, I <sub>D</sub> = 100 A, V <sub>GS</sub> = 10 V (Note 4)	–	77	100	nC
Q <sub>gs</sub>	Gate to Source Gate Charge		–	26	–	nC
Q <sub>gs2</sub>	Gate Charge Threshold to Plateau		–	11	–	nC
Q <sub>gd</sub>	Gate to Drain “Miller” Charge		–	16	–	nC
ESR	Equivalent Series Resistance (G–S)	f = 1 MHz	–	2.29	–	Ω

### SWITCHING CHARACTERISTICS

t <sub>d(on)</sub>	Turn-On Delay Time	V <sub>DD</sub> = 75 V, I <sub>D</sub> = 100 A, V <sub>GS</sub> = 10 V, R <sub>G</sub> = 4.7 Ω (Note 4)	–	28	66	ns
t <sub>r</sub>	Turn-On Rise Time		–	37	84	ns
t <sub>d(off)</sub>	Turn-Off Delay Time		–	62	134	ns
t <sub>f</sub>	Turn-Off Fall Time		–	21	52	ns

### DRAIN-SOURCE DIODE CHARACTERISTICS

I <sub>S</sub>	Maximum Continuous Drain to Source Diode Forward Current	–	–	130*	A	
I <sub>SM</sub>	Maximum Pulsed Drain to Source Diode Forward Current	–	–	520	A	
V <sub>SD</sub>	Drain to Source Diode Forward Voltage	V <sub>GS</sub> = 0 V, I <sub>SD</sub> = 100 A	–	–	1.25	V
t <sub>rr</sub>	Reverse Recovery Time	V <sub>GS</sub> = 0 V, V <sub>DD</sub> = 75 V, I <sub>SD</sub> = 100 A, dI <sub>F</sub> /dt = 100 A/μs	–	97	–	ns
Q <sub>rr</sub>	Reverse Recovery Charge		–	264	–	nC

Product parametric performance is indicated in the Electrical Characteristics for the listed test conditions, unless otherwise noted. Product performance may not be indicated by the Electrical Characteristics if operated under different conditions.

4. Essentially independent of operating temperature typical characteristics.

TYPICAL PERFORMANCE CHARACTERISTICS

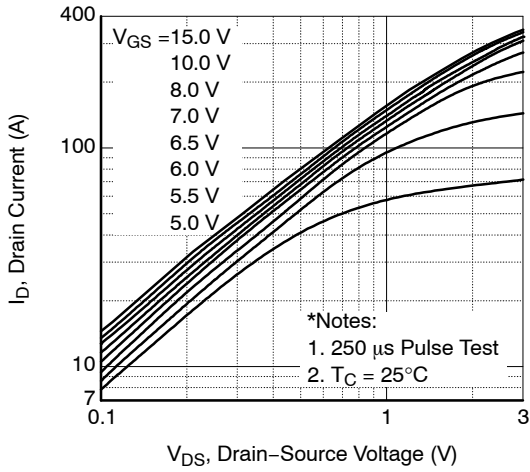

Figure 1. On-Region Characteristics

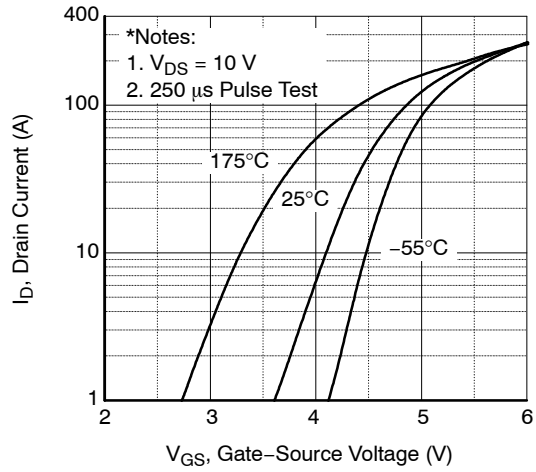

Figure 2. Transfer Characteristics

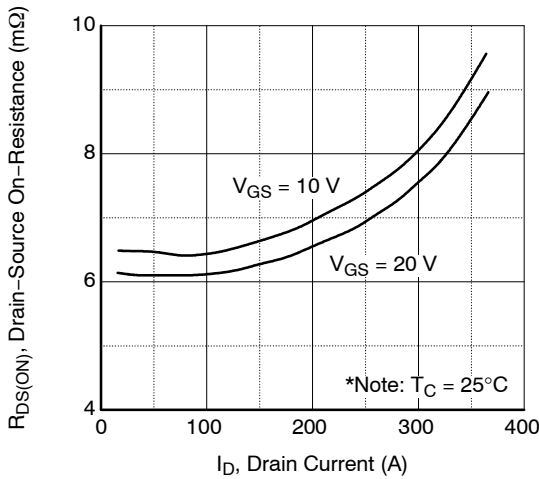

Figure 3. On-Resistance Variation vs. Drain Current and Gate Voltage

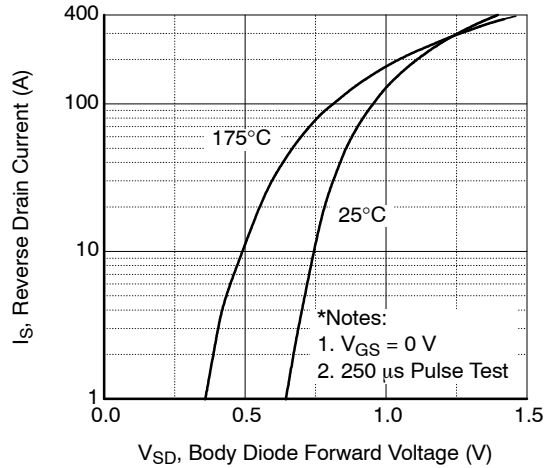

Figure 4. Body Diode Forward Voltage Variation vs. Source Current and Temperature

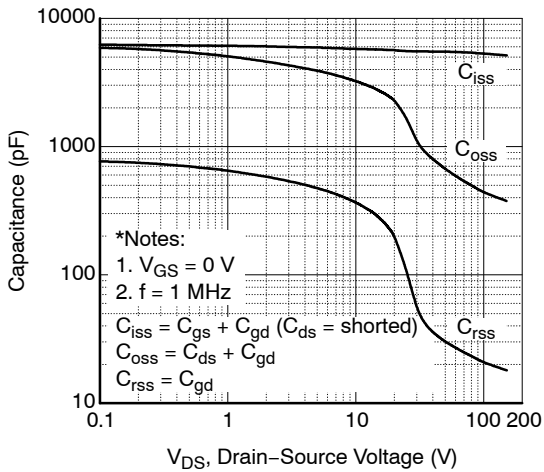

Figure 5. Capacitance Characteristics

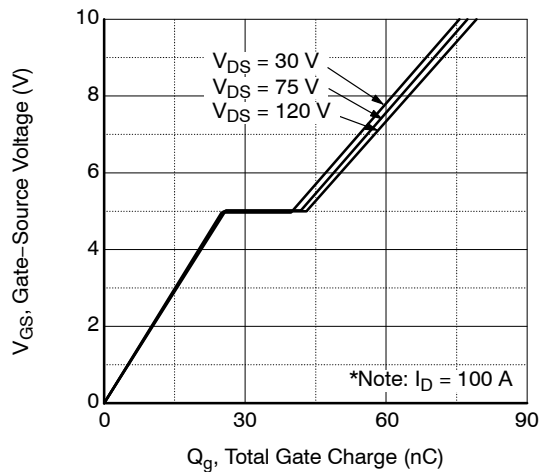
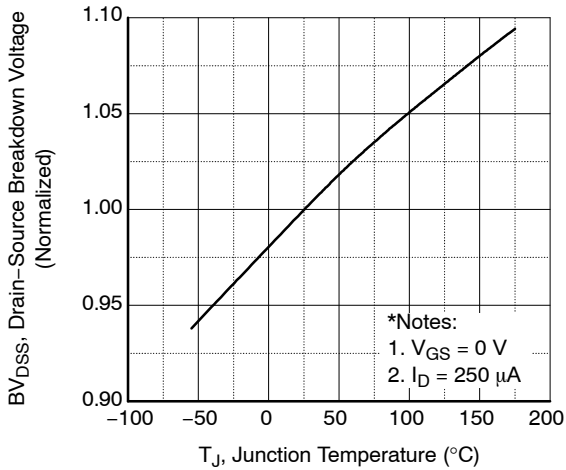

Figure 6. Gate Charge Characteristics

# FDP075N15A, FDB075N15A

## TYPICAL PERFORMANCE CHARACTERISTICS (Continued)



**Figure 7. Breakdown Voltage Variation vs. Temperature**

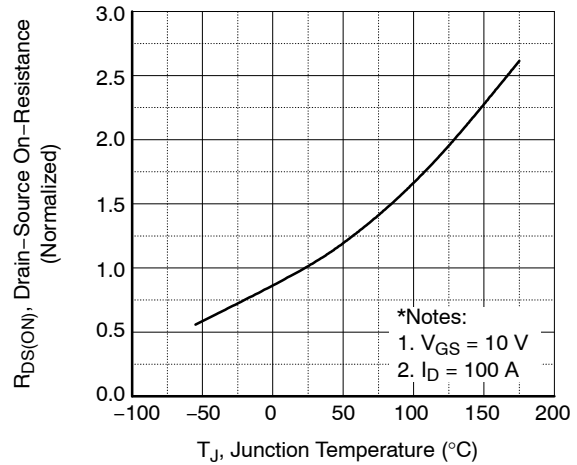

**Figure 8. On-Resistance Variation vs. Temperature**

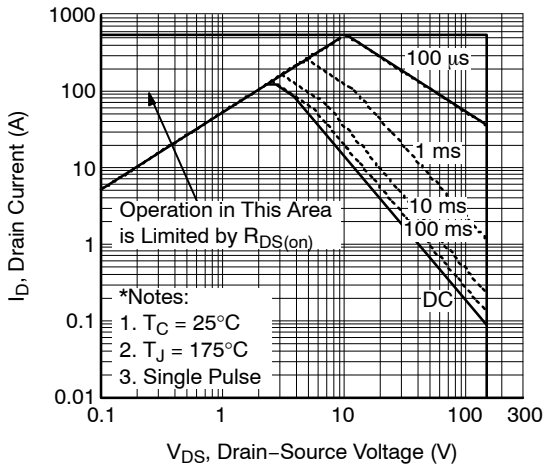

**Figure 9. Maximum Safe Operating Area**

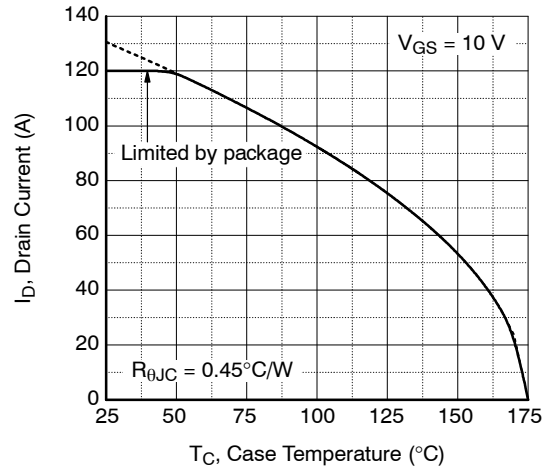

**Figure 10. Maximum Drain Current vs. Case Temperature**

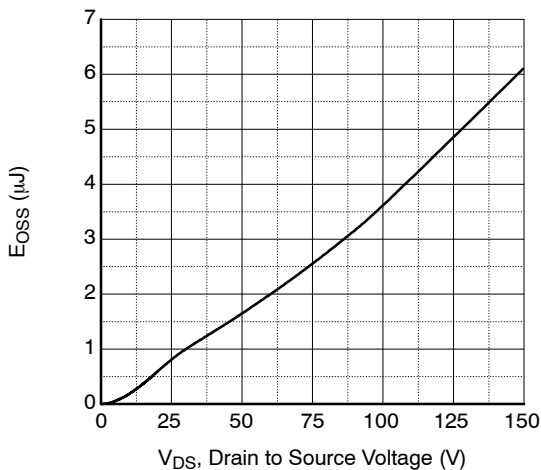

**Figure 11. E<sub>oss</sub> vs. Drain to Source Voltage**

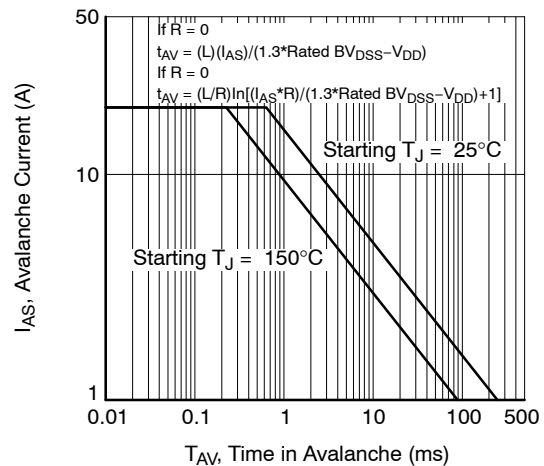

**Figure 12. Unclamped Inductive Switching Capability**

# FDP075N15A, FDB075N15A

## TYPICAL PERFORMANCE CHARACTERISTICS (Continued)

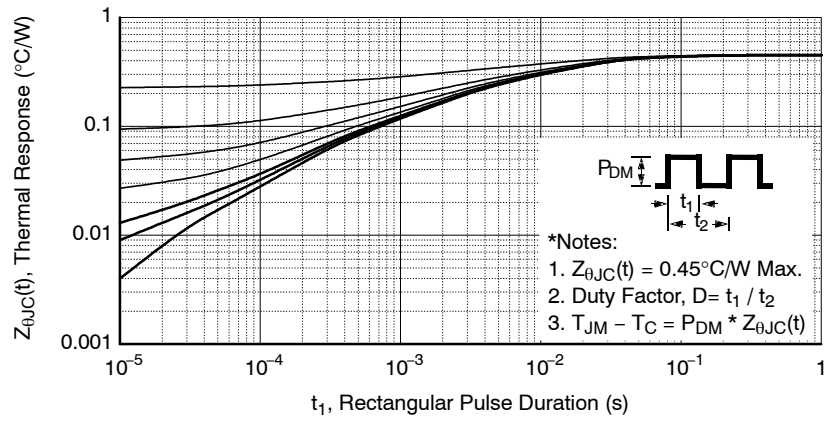

Figure 13. Transient Thermal Response Curve

FDP075N15A, FDB075N15A

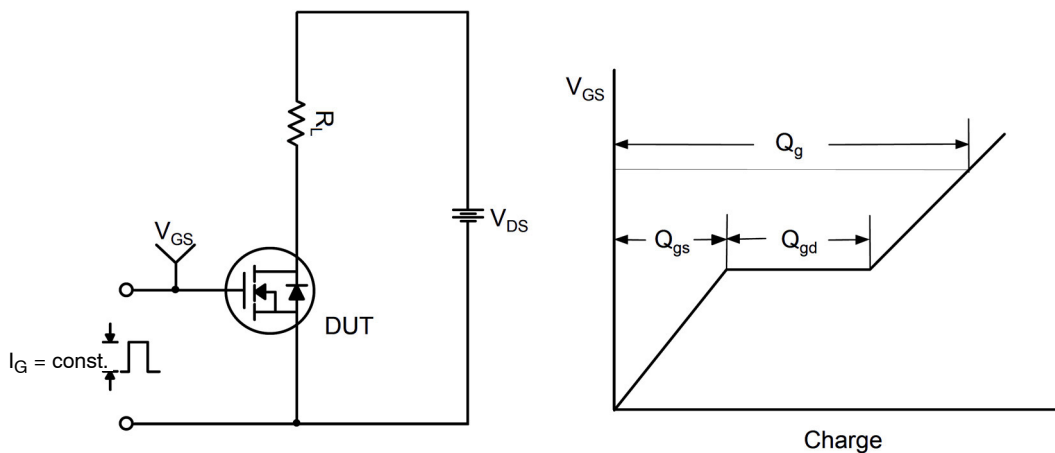

Figure 14. Gate Charge Test Circuit & Waveform

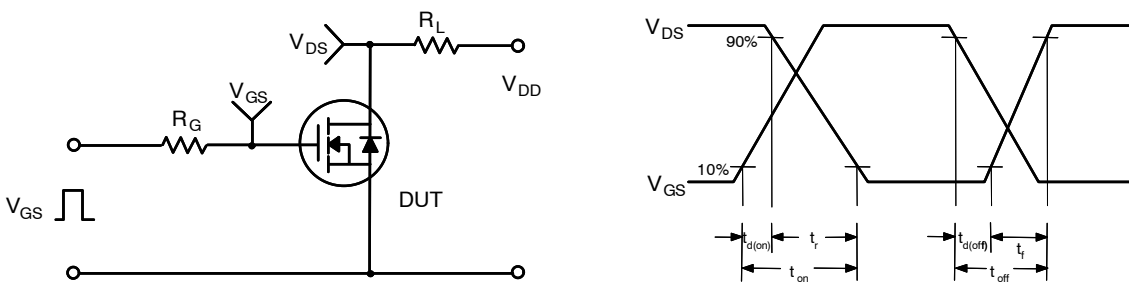

Figure 15. Resistive Switching Test Circuit & Waveforms

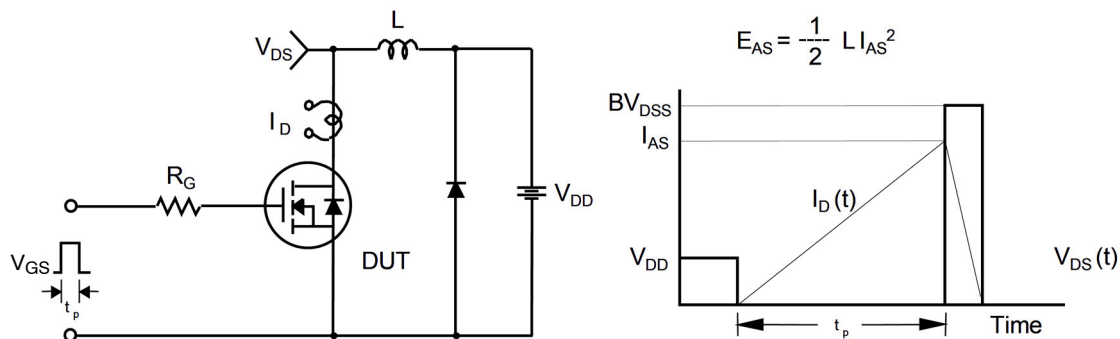
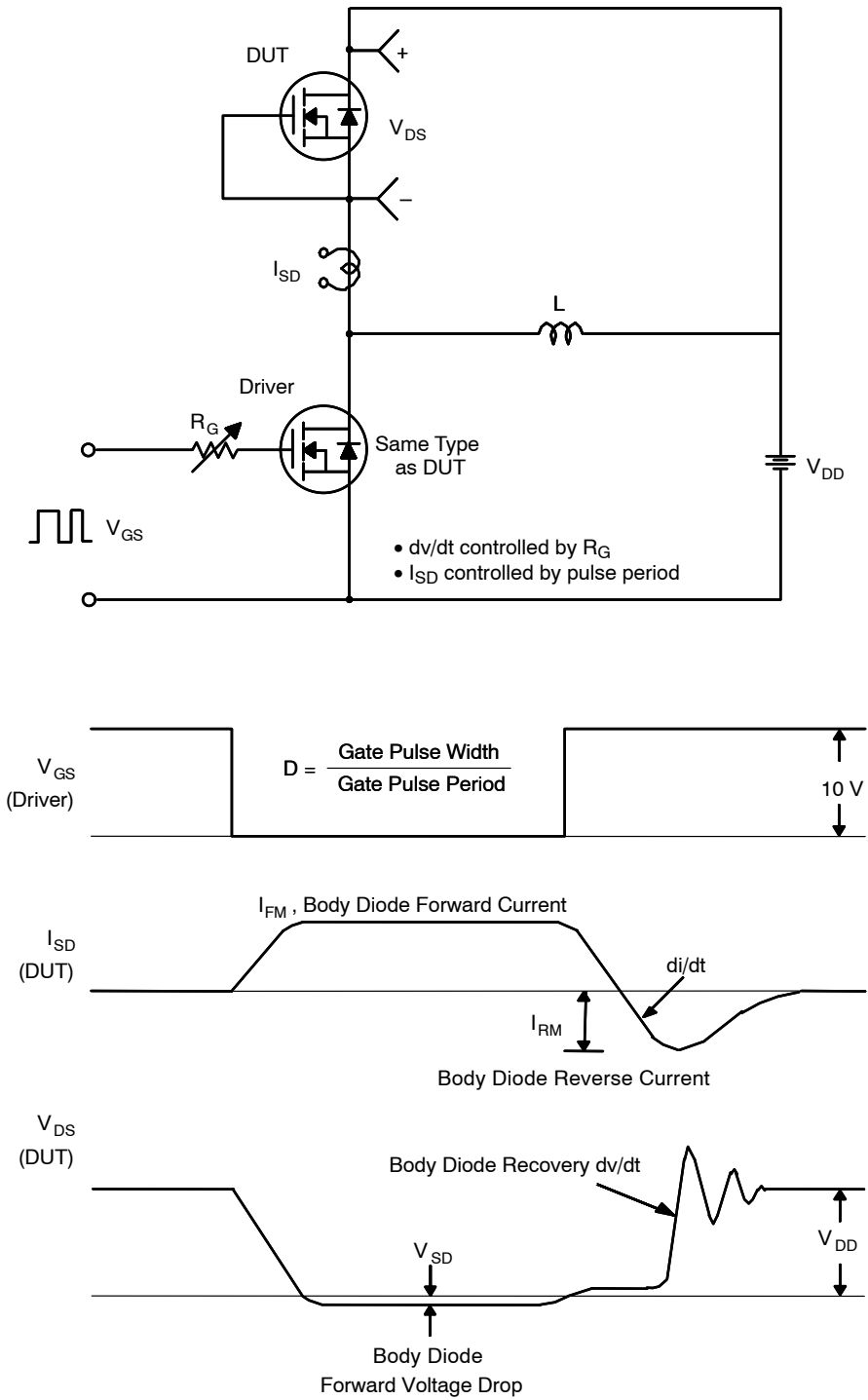

Figure 16. Unclamped Inductive Switching Test Circuit & Waveforms

# FDP075N15A, FDB075N15A



**Figure 17. Peak Diode Recovery  $dv/dt$  Test Circuit & Waveforms**



## FDP075N15A, FDB075N15A

### PACKAGE MARKING AND ORDERING INFORMATION

Part Number	Top Mark	Package	Reel Size	Tape Width	Shipping†
FDP075N15A-F102	FDP075N15A	TO-220	N/A	N/A	50 units / Tube
FDB075N15A	FDB075N15A	D <sup>2</sup> -PAK	330 mm	24 mm	800 units / Tape & Reel

†For information on tape and reel specifications, including part orientation and tape sizes, please refer to our Tape and Reel Packaging Specifications Brochure, BRD8011/D.

POWERTRENCH is registered trademark of Semiconductor Components Industries, LLC dba "onsemi" or its affiliates and/or subsidiaries in the United States and/or other countries.

# MECHANICAL CASE OUTLINE PACKAGE DIMENSIONS

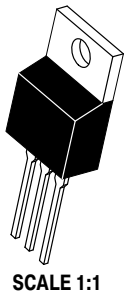

## TO-220 CASE 221A ISSUE AK

DATE 13 JAN 2022

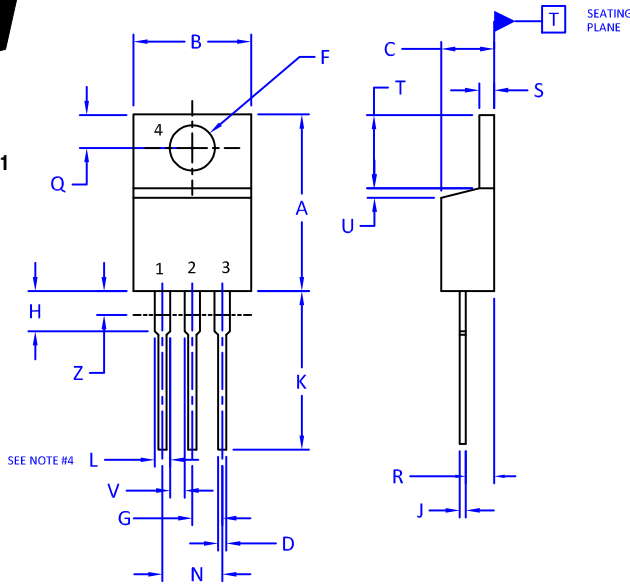

NOTES:

1. DIMENSIONING AND TOLERANCING PER ANSI Y14.5M, 2009.
2. CONTROLLING DIMENSION: INCHES
3. DIMENSION Z DEFINES A ZONE WHERE ALL BODY AND LEAD IRREGULARITIES ARE ALLOWED.
4. MAX WIDTH FOR F102 DEVICE = 1.35MM

DIM	INCHES		MILLIMETERS	
	MIN.	MAX.	MIN.	MAX.
A	0.570	0.620	14.48	15.75
B	0.380	0.415	9.66	10.53
C	0.160	0.190	4.07	4.83
D	0.025	0.038	0.64	0.96
F	0.142	0.161	3.60	4.09
G	0.095	0.105	2.42	2.66
H	0.110	0.161	2.80	4.10
J	0.014	0.024	0.36	0.61
K	0.500	0.562	12.70	14.27
L	0.045	0.060	1.15	1.52
N	0.190	0.210	4.83	5.33
Q	0.100	0.120	2.54	3.04
R	0.080	0.110	2.04	2.79
S	0.045	0.055	1.15	1.41
T	0.235	0.255	5.97	6.47
U	0.000	0.050	0.00	1.27
V	0.045	---	1.15	---
Z	---	0.080	---	2.04

STYLE 1:  
PIN 1. BASE  
2. COLLECTOR  
3. EMITTER  
4. COLLECTOR

STYLE 2:  
PIN 1. BASE  
2. EMITTER  
3. COLLECTOR  
4. EMITTER

STYLE 3:  
PIN 1. CATHODE  
2. ANODE  
3. GATE  
4. ANODE

STYLE 4:  
PIN 1. MAIN TERMINAL 1  
2. MAIN TERMINAL 2  
3. GATE  
4. MAIN TERMINAL 2

STYLE 5:  
PIN 1. GATE  
2. DRAIN  
3. SOURCE  
4. DRAIN

STYLE 6:  
PIN 1. ANODE  
2. CATHODE  
3. ANODE  
4. CATHODE

STYLE 7:  
PIN 1. CATHODE  
2. ANODE  
3. CATHODE  
4. ANODE

STYLE 8:  
PIN 1. CATHODE  
2. ANODE  
3. EXTERNAL TRIP/DELAY  
4. ANODE

STYLE 9:  
PIN 1. GATE  
2. COLLECTOR  
3. EMITTER  
4. COLLECTOR

STYLE 10:  
PIN 1. GATE  
2. SOURCE  
3. DRAIN  
4. SOURCE

STYLE 11:  
PIN 1. DRAIN  
2. SOURCE  
3. GATE  
4. SOURCE

STYLE 12:  
PIN 1. MAIN TERMINAL 1  
2. MAIN TERMINAL 2  
3. GATE  
4. NOT CONNECTED

DOCUMENT NUMBER:	98ASB42148B	Electronic versions are uncontrolled except when accessed directly from the Document Repository. Printed versions are uncontrolled except when stamped "CONTROLLED COPY" in red.
DESCRIPTION:	TO-220	PAGE 1 OF 1

onsemi and onsemi are trademarks of Semiconductor Components Industries, LLC dba onsemi or its subsidiaries in the United States and/or other countries. onsemi reserves the right to make changes without further notice to any products herein. onsemi makes no warranty, representation or guarantee regarding the suitability of its products for any particular purpose, nor does onsemi assume any liability arising out of the application or use of any product or circuit, and specifically disclaims any and all liability, including without limitation special, consequential or incidental damages. onsemi does not convey any license under its patent rights nor the rights of others.

# MECHANICAL CASE OUTLINE

## PACKAGE DIMENSIONS

ON Semiconductor®

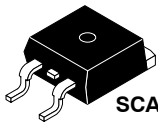

SCALE 1:1

### D<sup>2</sup>PAK-3 (TO-263, 3-LEAD)

#### CASE 418AJ

#### ISSUE F

DATE 11 MAR 2021

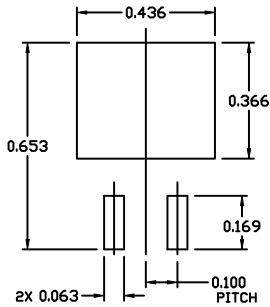

#### RECOMMENDED MOUNTING FOOTPRINT

■ For additional information on our Pb-Free strategy and soldering details, please download the ON Semiconductor Soldering and Mounting Techniques Reference Manual, SOLDERRM/D.

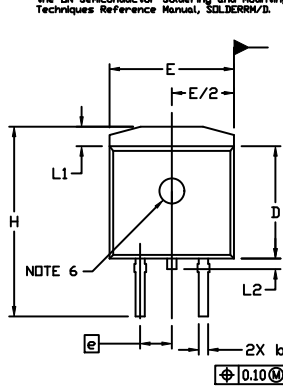

#### NOTES:

1. DIMENSIONING AND TOLERANCING PER ASME Y14.5M, 2009.
2. CONTROLLING DIMENSION: INCHES
3. CHAMFER OPTIONAL.
4. DIMENSIONS D AND E DO NOT INCLUDE MOLD FLASH. MOLD FLASH SHALL NOT EXCEED 0.005 PER SIDE. THESE DIMENSIONS ARE MEASURED AT THE OUTERMOST EXTREMES OF THE PLASTIC BODY AT DATUM H.
5. THERMAL PAD CONTOUR IS OPTIONAL WITHIN DIMENSIONS E, L1, D1, AND E1.
6. OPTIONAL MOLD FEATURE.
7. Ⓚ, Ⓛ ... OPTIONAL CONSTRUCTION FEATURE CALL OUTS.

DIM	INCHES		MILLIMETERS	
	MIN.	MAX.	MIN.	MAX.
A	0.160	0.190	4.06	4.83
A1	0.000	0.010	0.00	0.25
b	0.020	0.039	0.51	0.99
c	0.012	0.029	0.30	0.74
c2	0.045	0.065	1.14	1.65
D	0.330	0.380	8.38	9.65
D1	0.260	---	6.60	---
E	0.380	0.420	9.65	10.67
E1	0.245	---	6.22	---
e	0.100	BSC	2.54	BSC
H	0.575	0.625	14.60	15.88
L	0.070	0.110	1.78	2.79
L1	---	0.066	---	1.68
L2	---	0.070	---	1.78
L3	0.010	BSC	0.25	BSC
M	0*	8*	0*	8*

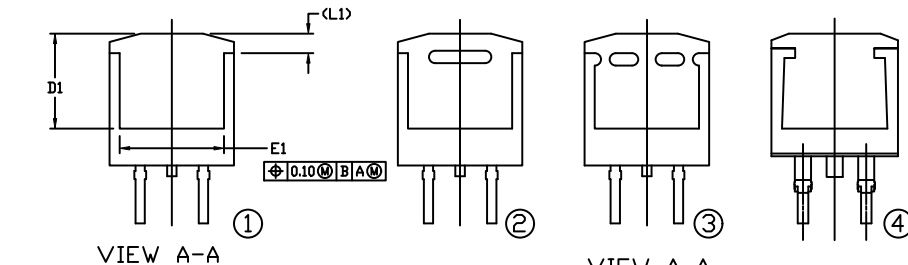
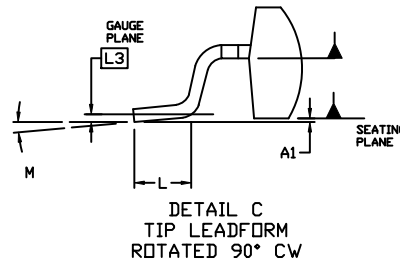
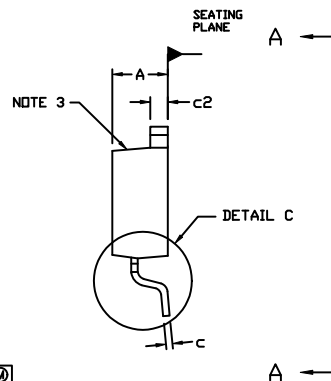

VIEW A-A

VIEW A-A  
OPTIONAL CONSTRUCTIONS

#### GENERIC MARKING DIAGRAMS\*

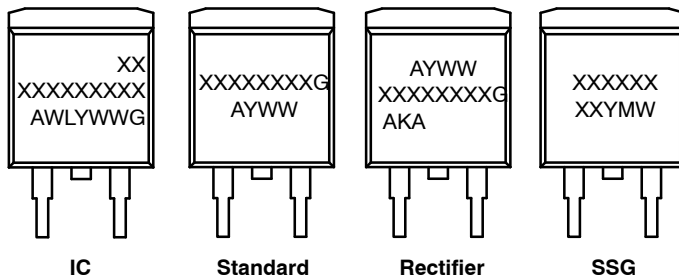

IC

Standard

Rectifier

SSG

- XXXXXX = Specific Device Code
- A = Assembly Location
- WL = Wafer Lot
- Y = Year
- WW = Work Week
- W = Week Code (SSG)
- M = Month Code (SSG)
- G = Pb-Free Package
- AKA = Polarity Indicator

\*This information is generic. Please refer to device data sheet for actual part marking. Pb-Free indicator, "G" or microdot "▪", may or may not be present. Some products may not follow the Generic Marking.

<b>DOCUMENT NUMBER:</b>	<b>98AON56370E</b>	Electronic versions are uncontrolled except when accessed directly from the Document Repository. Printed versions are uncontrolled except when stamped "CONTROLLED COPY" in red.
<b>DESCRIPTION:</b>	<b>D<sup>2</sup>PAK-3 (TO-263, 3-LEAD)</b>	<b>PAGE 1 OF 1</b>

ON Semiconductor and ON are trademarks of Semiconductor Components Industries, LLC dba ON Semiconductor or its subsidiaries in the United States and/or other countries. ON Semiconductor reserves the right to make changes without further notice to any products herein. ON Semiconductor makes no warranty, representation or guarantee regarding the suitability of its products for any particular purpose, nor does ON Semiconductor assume any liability arising out of the application or use of any product or circuit, and specifically disclaims any and all liability, including without limitation special, consequential or incidental damages. ON Semiconductor does not convey any license under its patent rights nor the rights of others.

**onsemi**, **Onsemi**, and other names, marks, and brands are registered and/or common law trademarks of Semiconductor Components Industries, LLC dba "**onsemi**" or its affiliates and/or subsidiaries in the United States and/or other countries. **onsemi** owns the rights to a number of patents, trademarks, copyrights, trade secrets, and other intellectual property. A listing of **onsemi**'s product/patent coverage may be accessed at [www.onsemi.com/site/pdf/Patent-Marking.pdf](http://www.onsemi.com/site/pdf/Patent-Marking.pdf). **onsemi** reserves the right to make changes at any time to any products or information herein, without notice. The information herein is provided "as-is" and **onsemi** makes no warranty, representation or guarantee regarding the accuracy of the information, product features, availability, functionality, or suitability of its products for any particular purpose, nor does **onsemi** assume any liability arising out of the application or use of any product or circuit, and specifically disclaims any and all liability, including without limitation special, consequential or incidental damages. Buyer is responsible for its products and applications using **onsemi** products, including compliance with all laws, regulations and safety requirements or standards, regardless of any support or applications information provided by **onsemi**. "Typical" parameters which may be provided in **onsemi** data sheets and/or specifications can and do vary in different applications and actual performance may vary over time. All operating parameters, including "Typicals" must be validated for each customer application by customer's technical experts. **onsemi** does not convey any license under any of its intellectual property rights nor the rights of others. **onsemi** products are not designed, intended, or authorized for use as a critical component in life support systems or any FDA Class 3 medical devices or medical devices with a same or similar classification in a foreign jurisdiction or any devices intended for implantation in the human body. Should Buyer purchase or use **onsemi** products for any such unintended or unauthorized application, Buyer shall indemnify and hold **onsemi** and its officers, employees, subsidiaries, affiliates, and distributors harmless against all claims, costs, damages, and expenses, and reasonable attorney fees arising out of, directly or indirectly, any claim of personal injury or death associated with such unintended or unauthorized use, even if such claim alleges that **onsemi** was negligent regarding the design or manufacture of the part. **onsemi** is an Equal Opportunity/Affirmative Action Employer. This literature is subject to all applicable copyright laws and is not for resale in any manner.

## PUBLICATION ORDERING INFORMATION

### LITERATURE FULFILLMENT:

Email Requests to: [orderlit@onsemi.com](mailto:orderlit@onsemi.com)

**onsemi Website:** [www.onsemi.com](http://www.onsemi.com)

### TECHNICAL SUPPORT

**North American Technical Support:**  
Voice Mail: 1 800-282-9855 Toll Free USA/Canada  
Phone: 011 421 33 790 2910

**Europe, Middle East and Africa Technical Support:**

Phone: 00421 33 790 2910

For additional information, please contact your local Sales Representative