

NCV8440, NCV8440A

Protected Power MOSFET

2.6 A, 52 V, N-Channel, Logic Level, Clamped MOSFET w/ ESD Protection

Features

- Diode Clamp Between Gate and Source
- ESD Protection – Human Body Model 5000 V
- Active Over-Voltage Gate to Drain Clamp
- Scalable to Lower or Higher $R_{DS(on)}$
- Internal Series Gate Resistance
- These are Pb-Free Devices

Benefits

- High Energy Capability for Inductive Loads
- Low Switching Noise Generation

Applications

- Automotive and Industrial Markets:
Solenoid Drivers, Lamp Drivers, Small Motor Drivers
- NCV Prefix for Automotive and Other Applications Requiring Unique Site and Control Change Requirements; AEC-Q100 Qualified and PPAP Capable



ON Semiconductor®

www.onsemi.com

V_{DSS} (Clamped)	$R_{DS(on)}$ TYP	I_D MAX
52 V	95 mΩ @ 10 V	2.6 A

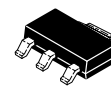
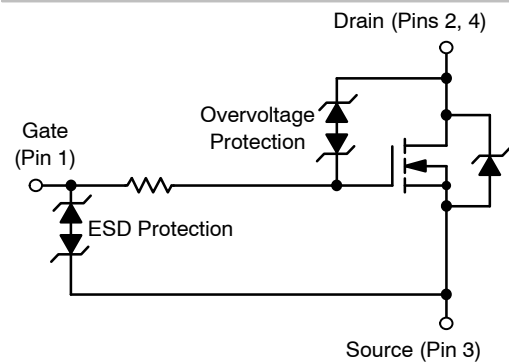

SOT-223
CASE 318E
STYLE 3

1 = Gate
2 = Drain
3 = Source

MARKING DIAGRAM

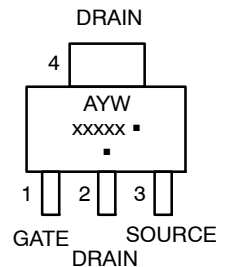

A = Assembly Location
Y = Year
W = Work Week
xxxxx = V8440 or 8440A
▪ = Pb-Free Package

(Note: Microdot may be in either location)

ORDERING INFORMATION

See detailed ordering and shipping information in the package dimensions section on page 8 of this data sheet.

NCV8440, NCV8440A

MAXIMUM RATINGS ($T_J = 25^\circ\text{C}$ unless otherwise noted)

Rating	Symbol	Value	Unit
Drain-to-Source Voltage Internally Clamped	V_{DSS}	52-59	V
Gate-to-Source Voltage – Continuous	V_{GS}	± 15	V
Drain Current – Continuous @ $T_A = 25^\circ\text{C}$ – Single Pulse ($t_p = 10 \mu\text{s}$) (Note 1)	I_D	2.6	A
	I_{DM}	10	A
Total Power Dissipation @ $T_A = 25^\circ\text{C}$ (Note 1)	P_D	1.69	W
Operating and Storage Temperature Range	T_J, T_{stg}	-55 to 150	$^\circ\text{C}$
Single Pulse Drain-to-Source Avalanche Energy ($V_{DD} = 50 \text{ V}$, $I_{D(pk)} = 1.17 \text{ A}$, $V_{GS} = 10 \text{ V}$, $L = 160 \text{ mH}$, $R_G = 25 \Omega$)	E_{AS}	110	mJ
Load Dump Voltage ($V_{GS} = 0$ and 10 V , $R_I = 2.0 \Omega$, $R_L = 9.0 \Omega$, $t_d = 400 \text{ ms}$)	V_{LD}	60	V
Thermal Resistance, Junction-to-Ambient (Note 1) Junction-to-Ambient (Note 2)	$R_{\theta JA}$	74	$^\circ\text{C/W}$
	$R_{\theta JA}$	169	$^\circ\text{C/W}$
Maximum Lead Temperature for Soldering Purposes, 1/8" from Case for 10 Seconds	T_L	260	$^\circ\text{C}$

Stresses exceeding those listed in the Maximum Ratings table may damage the device. If any of these limits are exceeded, device functionality should not be assumed, damage may occur and reliability may be affected.

1. When surface mounted to a FR4 board using 1" pad size, (Cu area 1.127 in²).
2. When surface mounted to a FR4 board using minimum recommended pad size, (Cu area 0.412 in²).

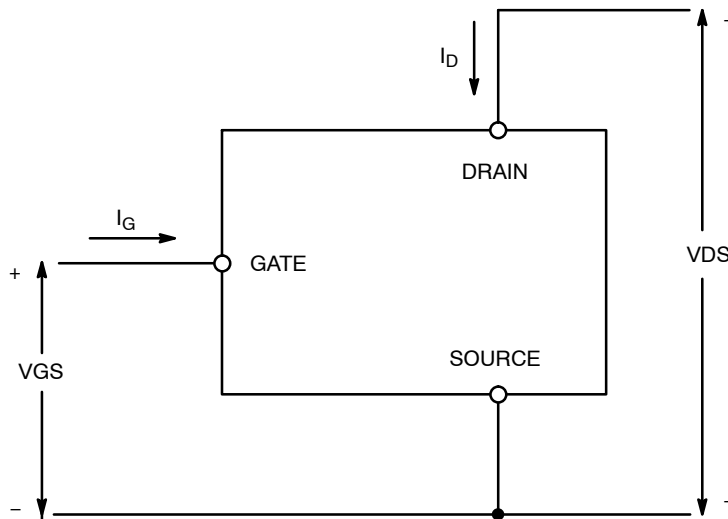

Figure 1. Voltage and Current Convention

NCV8440, NCV8440A

MOSFET ELECTRICAL CHARACTERISTICS ($T_J = 25^\circ\text{C}$ unless otherwise noted)

Characteristic	Symbol	Min	Typ	Max	Unit
----------------	--------	-----	-----	-----	------

OFF CHARACTERISTICS

Drain-to-Source Breakdown Voltage (Note 3) $(V_{GS} = 0\text{ V}, I_D = 1.0\text{ mA}, T_J = 25^\circ\text{C})$ $(V_{GS} = 0\text{ V}, I_D = 1.0\text{ mA}, T_J = -40^\circ\text{C to } 125^\circ\text{C})$ (Note 4) Temperature Coefficient (Negative)	$V_{(BR)DSS}$	52 50.8	55 54 -9.3	59 59.5	V V mV/ $^\circ\text{C}$
Zero Gate Voltage Drain Current $(V_{DS} = 40\text{ V}, V_{GS} = 0\text{ V})$ $(V_{DS} = 40\text{ V}, V_{GS} = 0\text{ V}, T_J = 125^\circ\text{C})$ (Note 4)	I_{DSS}			10 25	μA
Gate-Body Leakage Current $(V_{GS} = \pm 8\text{ V}, V_{DS} = 0\text{ V})$ $(V_{GS} = \pm 14\text{ V}, V_{DS} = 0\text{ V})$	I_{GSS}		± 35	± 10	μA

ON CHARACTERISTICS (Note 3)

Gate Threshold Voltage (Note 3) $(V_{DS} = V_{GS}, I_D = 100\ \mu\text{A})$ Threshold Temperature Coefficient (Negative)	$V_{GS(th)}$	1.1	1.5 -4.1	1.9	V mV/ $^\circ\text{C}$
Static Drain-to-Source On-Resistance (Note 3) $(V_{GS} = 3.5\text{ V}, I_D = 0.6\text{ A})$ $(V_{GS} = 4.0\text{ V}, I_D = 1.5\text{ A})$ $(V_{GS} = 10\text{ V}, I_D = 2.6\text{ A})$	$R_{DS(on)}$		150 135 95	180 160 110	m Ω
Forward Transconductance (Note 3) ($V_{DS} = 15\text{ V}, I_D = 2.6\text{ A}$)	g_{FS}		3.8		Mhos

DYNAMIC CHARACTERISTICS

Input Capacitance	$V_{DS} = 35\text{ V}, V_{GS} = 0\text{ V},$ $f = 10\text{ kHz}$	C_{iss}		155		μF
Output Capacitance		C_{oss}		60		
Transfer Capacitance		C_{rss}		25		
Input Capacitance	$V_{DS} = 25\text{ V}, V_{GS} = 0\text{ V},$ $f = 10\text{ kHz}$	C_{iss}		170		μF
Output Capacitance		C_{oss}		70		
Transfer Capacitance		C_{rss}		30		

Product parametric performance is indicated in the Electrical Characteristics for the listed test conditions, unless otherwise noted. Product performance may not be indicated by the Electrical Characteristics if operated under different conditions.

3. Pulse Test: Pulse Width $\leq 300\ \mu\text{s}$, Duty Cycle $\leq 2\%$.
4. Not subject to production testing.
5. Switching characteristics are independent of operating junction temperatures.

NCV8440, NCV8440A

MOSFET ELECTRICAL CHARACTERISTICS ($T_J = 25^\circ\text{C}$ unless otherwise noted)

Characteristic	Symbol	Min	Typ	Max	Unit
SWITCHING CHARACTERISTICS (Note 5)					
Turn-On Delay Time	$V_{GS} = 4.5\text{ V}, V_{DD} = 40\text{ V}, I_D = 2.6\text{ A}, R_D = 15.4\ \Omega$	$t_{d(on)}$		375	ns
Rise Time		t_r		1525	
Turn-Off Delay Time		$t_{d(off)}$		1530	
Fall Time		t_f		1160	
Turn-On Delay Time	$V_{GS} = 4.5\text{ V}, V_{DD} = 40\text{ V}, I_D = 1.0\text{ A}, R_D = 40\ \Omega$	$t_{d(on)}$		325	ns
Rise Time		t_r		1275	
Turn-Off Delay Time		$t_{d(off)}$		1860	
Fall Time		t_f		1150	
Turn-On Delay Time	$V_{GS} = 10\text{ V}, V_{DD} = 15\text{ V}, I_D = 2.6\text{ A}, R_D = 5.8\ \Omega$	$t_{d(on)}$		190	ns
Rise Time		t_r		710	
Turn-Off Delay Time		$t_{d(off)}$		2220	
Fall Time		t_f		1180	
Gate Charge	$V_{GS} = 4.5\text{ V}, V_{DS} = 40\text{ V}, I_D = 2.6\text{ A (Note 3)}$	Q_T		4.5	nC
		Q_1		0.9	
		Q_2		2.6	
Gate Charge	$V_{GS} = 4.5\text{ V}, V_{DS} = 15\text{ V}, I_D = 1.5\text{ A (Note 3)}$	Q_T		3.9	nC
		Q_1		1.0	
		Q_2		1.7	

SOURCE-DRAIN DIODE CHARACTERISTICS

Forward On-Voltage	$I_S = 2.6\text{ A}, V_{GS} = 0\text{ V (Note 3)}$ $I_S = 2.6\text{ A}, V_{GS} = 0\text{ V}, T_J = 125^\circ\text{C}$	V_{SD}		0.81 0.66	1.5	V
Reverse Recovery Time	$I_S = 1.5\text{ A}, V_{GS} = 0\text{ V}, di_S/dt = 100\text{ A}/\mu\text{s (Note 3)}$	t_{rr}		730	ns	
		t_a		200		
		t_b		530		
Reverse Recovery Stored Charge		Q_{RR}		6.3		μC

ESD CHARACTERISTICS (Note 4)

Electro-Static Discharge Capability	Human Body Model (HBM)	ESD	5000			V
	Machine Model (MM)		500			

Product parametric performance is indicated in the Electrical Characteristics for the listed test conditions, unless otherwise noted. Product performance may not be indicated by the Electrical Characteristics if operated under different conditions.

3. Pulse Test: Pulse Width $\leq 300\ \mu\text{s}$, Duty Cycle $\leq 2\%$.
4. Not subject to production testing.
5. Switching characteristics are independent of operating junction temperatures.

TYPICAL PERFORMANCE CURVES

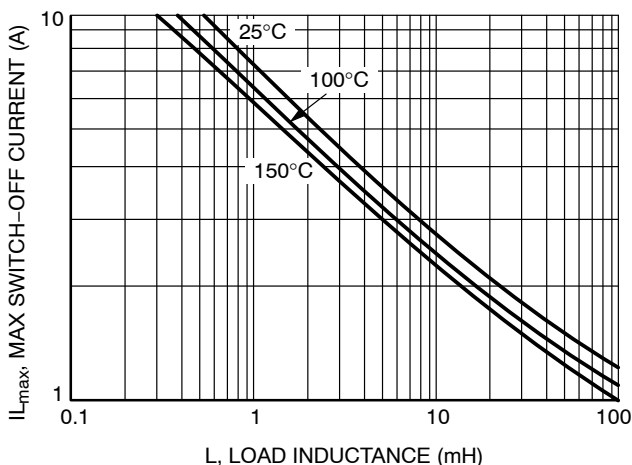

Figure 1. Single Pulse Maximum Switch-off Current vs. Load Inductance

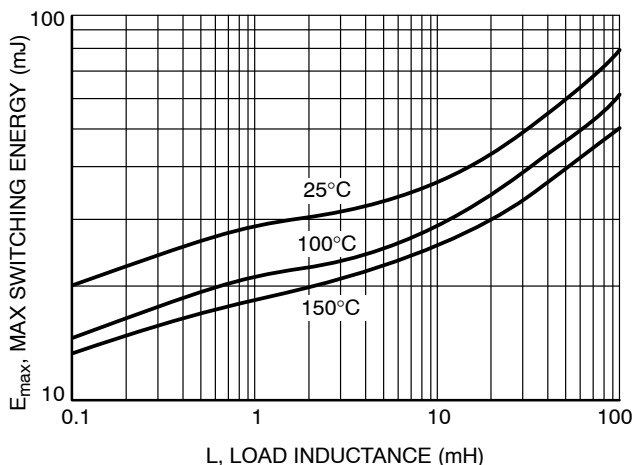

Figure 2. Single Pulse Maximum Switching Energy vs. Load Inductance

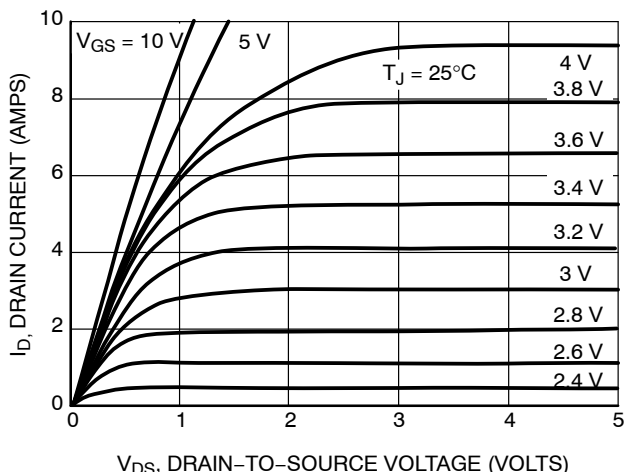

Figure 3. On-State Output Characteristics

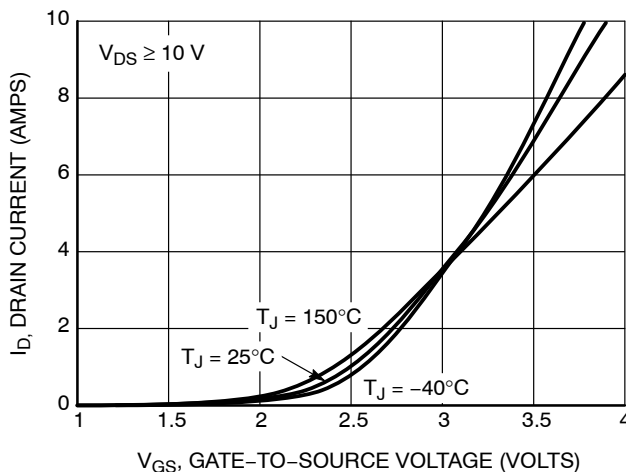

Figure 4. Transfer Characteristics

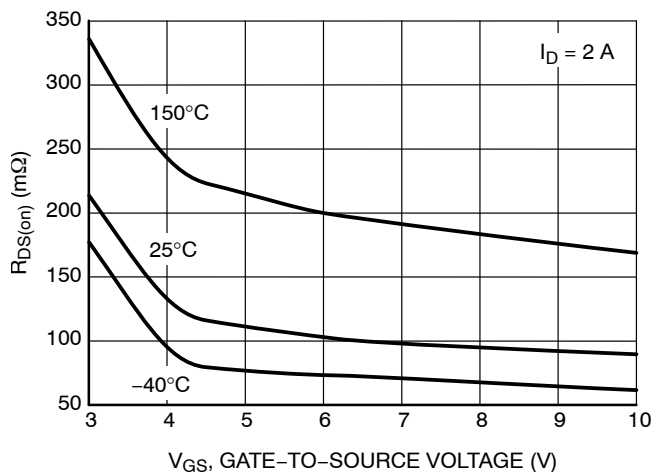

Figure 5. $R_{DS(on)}$ vs. Gate-Source Voltage

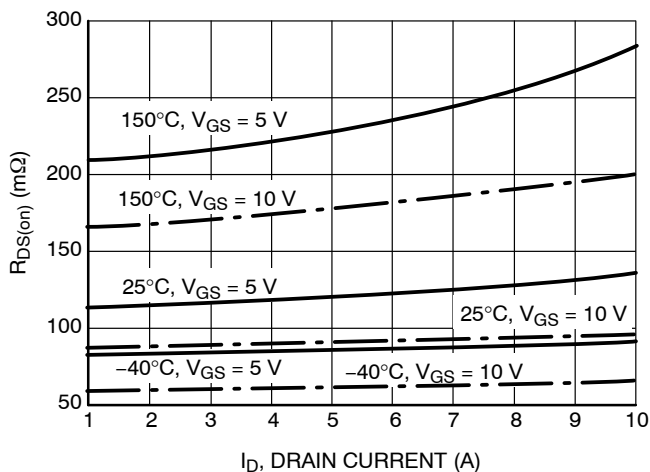

Figure 6. $R_{DS(on)}$ vs. Drain Current

TYPICAL PERFORMANCE CURVES

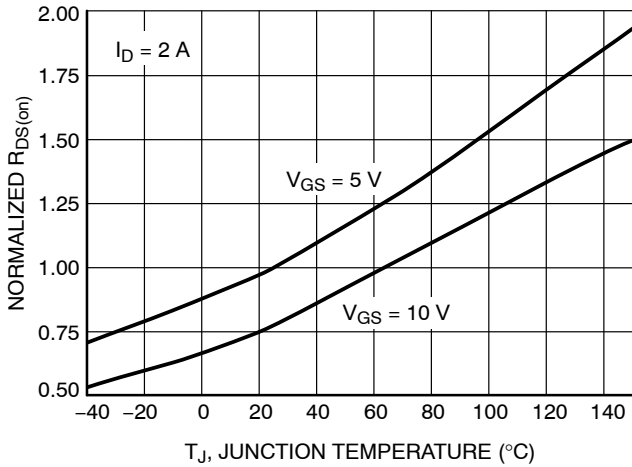

Figure 7. Normalized $R_{DS(on)}$ vs. Temperature

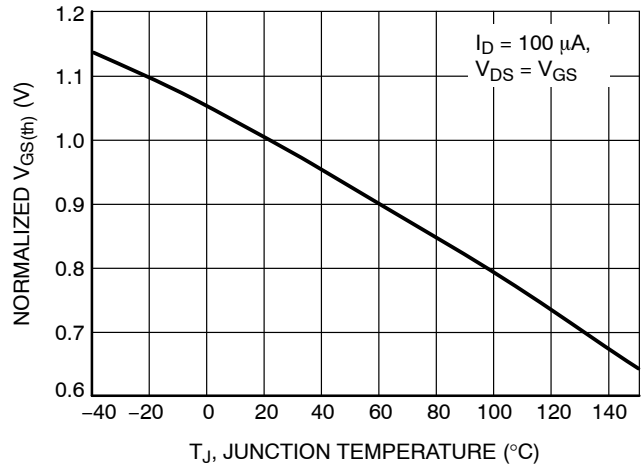

Figure 8. Normalized Threshold Voltage vs. Temperature

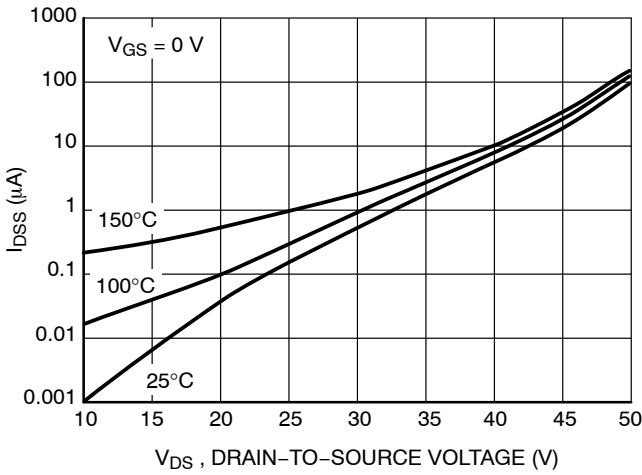

Figure 9. Drain-to-Source Leakage Current

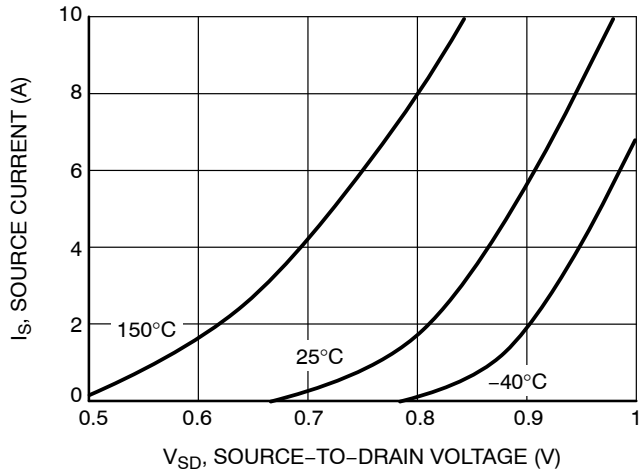

Figure 10. Source-Drain Diode Forward Characteristics

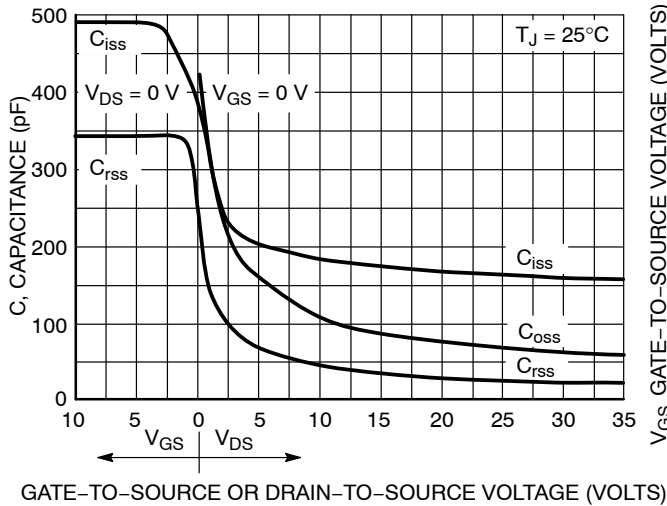

Figure 11. Capacitance Variation

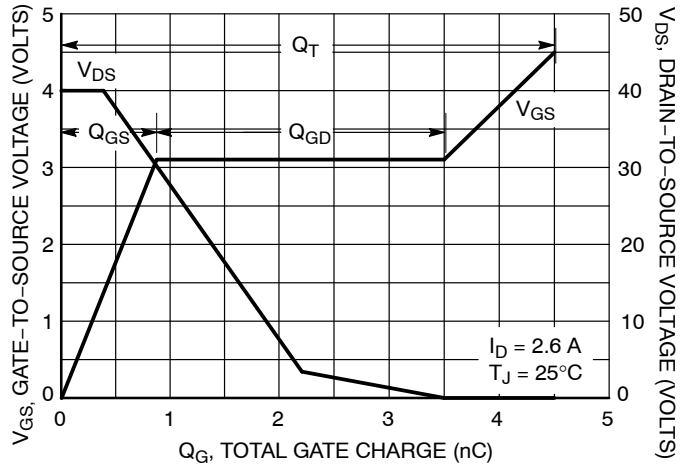

Figure 12. Gate-to-Source Voltage vs. Total Gate Charge

NCV8440, NCV8440A

TYPICAL PERFORMANCE CURVES

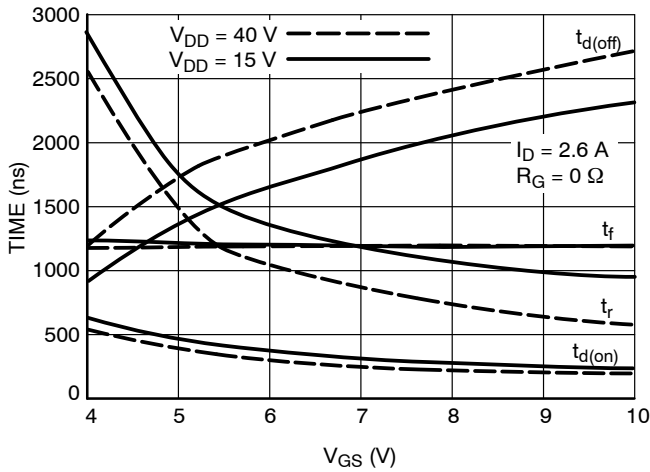

Figure 13. Resistive Load Switching Time vs. Gate-Source Voltage

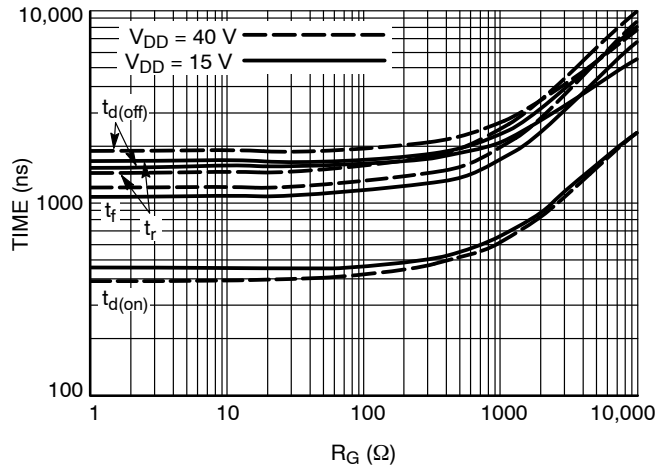

Figure 14. Resistive Load Switching Time vs. Gate Resistance ($V_{GS} = 5\text{ V}$, $I_D = 2.6\text{ A}$)

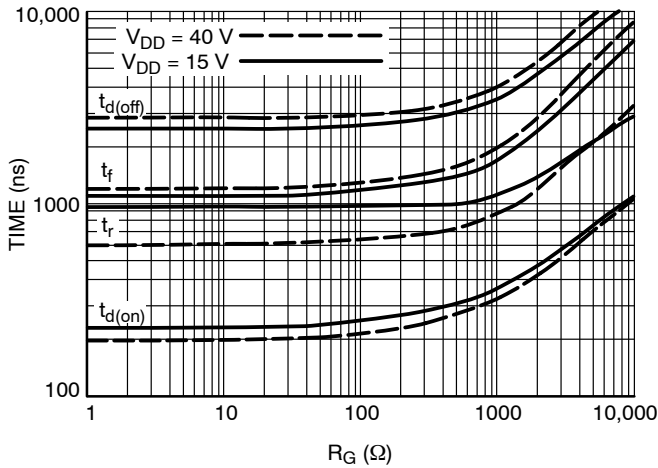

Figure 15. Resistive Load Switching Time vs. Gate Resistance ($V_{GS} = 10\text{ V}$, $I_D = 2.6\text{ A}$)

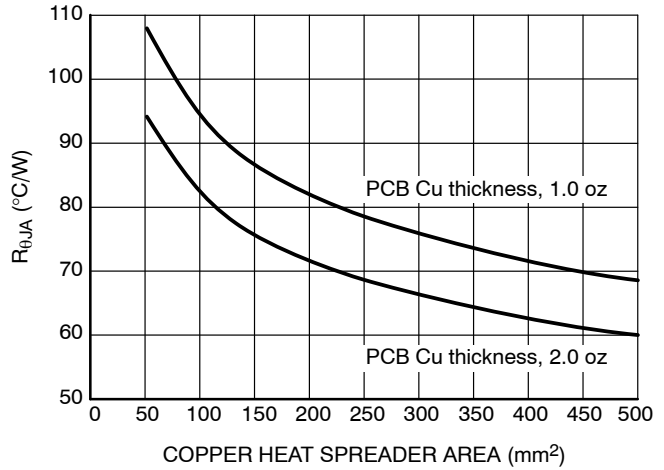

Figure 16. $R_{\theta JA}$ vs. Copper Area

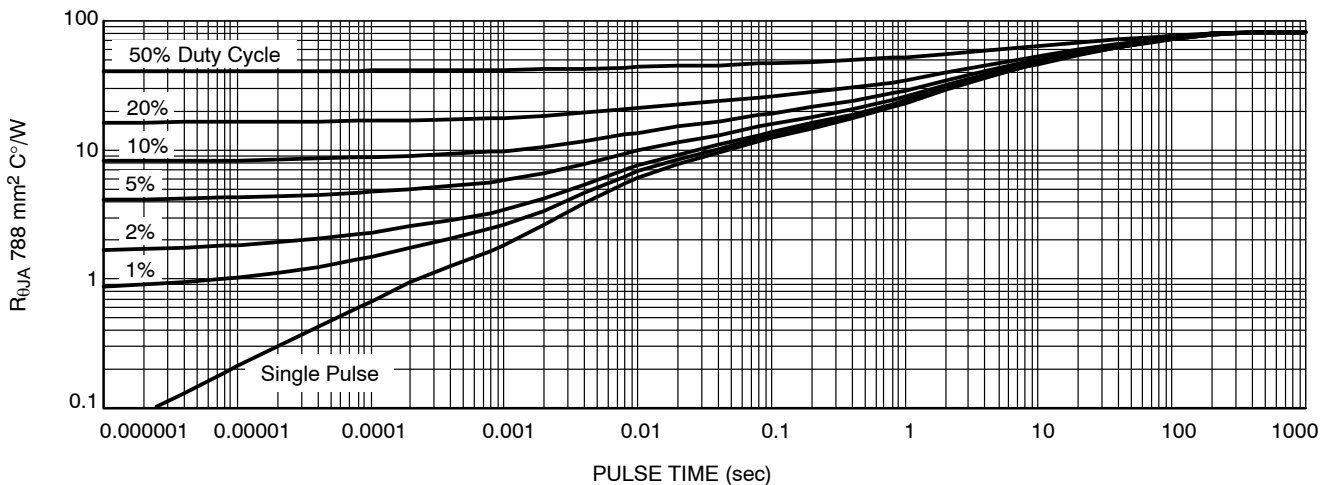

Figure 17. Transient Thermal Resistance

NCV8440, NCV8440A

ORDERING INFORMATION

Device	Package	Shipping†
NCV8440STT1G	SOT-223 (Pb-Free)	1000 / Tape & Reel
NCV8440ASTT1G	SOT-223 (Pb-Free)	1000 / Tape & Reel
NCV8440STT3G	SOT-223 (Pb-Free)	4000 / Tape & Reel
NCV8440ASTT3G	SOT-223 (Pb-Free)	4000 / Tape & Reel

†For information on tape and reel specifications, including part orientation and tape sizes, please refer to our Tape and Reel Packaging Specifications Brochure, BRD8011/D.

onsemi, **Onsemi**, and other names, marks, and brands are registered and/or common law trademarks of Semiconductor Components Industries, LLC dba "**onsemi**" or its affiliates and/or subsidiaries in the United States and/or other countries. **onsemi** owns the rights to a number of patents, trademarks, copyrights, trade secrets, and other intellectual property. A listing of **onsemi**'s product/patent coverage may be accessed at www.onsemi.com/site/pdf/Patent-Marking.pdf. **onsemi** reserves the right to make changes at any time to any products or information herein, without notice. The information herein is provided "as-is" and **onsemi** makes no warranty, representation or guarantee regarding the accuracy of the information, product features, availability, functionality, or suitability of its products for any particular purpose, nor does **onsemi** assume any liability arising out of the application or use of any product or circuit, and specifically disclaims any and all liability, including without limitation special, consequential or incidental damages. Buyer is responsible for its products and applications using **onsemi** products, including compliance with all laws, regulations and safety requirements or standards, regardless of any support or applications information provided by **onsemi**. "Typical" parameters which may be provided in **onsemi** data sheets and/or specifications can and do vary in different applications and actual performance may vary over time. All operating parameters, including "Typicals" must be validated for each customer application by customer's technical experts. **onsemi** does not convey any license under any of its intellectual property rights nor the rights of others. **onsemi** products are not designed, intended, or authorized for use as a critical component in life support systems or any FDA Class 3 medical devices or medical devices with a same or similar classification in a foreign jurisdiction or any devices intended for implantation in the human body. Should Buyer purchase or use **onsemi** products for any such unintended or unauthorized application, Buyer shall indemnify and hold **onsemi** and its officers, employees, subsidiaries, affiliates, and distributors harmless against all claims, costs, damages, and expenses, and reasonable attorney fees arising out of, directly or indirectly, any claim of personal injury or death associated with such unintended or unauthorized use, even if such claim alleges that **onsemi** was negligent regarding the design or manufacture of the part. **onsemi** is an Equal Opportunity/Affirmative Action Employer. This literature is subject to all applicable copyright laws and is not for resale in any manner.

PUBLICATION ORDERING INFORMATION

LITERATURE FULFILLMENT:

Email Requests to: orderlit@onsemi.com

onsemi Website: www.onsemi.com

TECHNICAL SUPPORT

North American Technical Support:

Voice Mail: 1 800-282-9855 Toll Free USA/Canada

Phone: 011 421 33 790 2910

Europe, Middle East and Africa Technical Support:

Phone: 00421 33 790 2910

For additional information, please contact your local Sales Representative