

2N4918 - 2N4920 Series

Medium-Power Plastic PNP Silicon Transistors

These medium-power, high-performance plastic devices are designed for driver circuits, switching, and amplifier applications.

Features

- Low Saturation Voltage – $V_{CE(sat)} = 0.6 \text{ Vdc (Max) @ } I_C = 1.0 \text{ A}$
- Excellent Power Dissipation, $P_D = 30 \text{ W @ } T_C = 25^\circ\text{C}$
- Excellent Safe Operating Area
- Gain Specified to $I_C = 1.0 \text{ A}$
- Complement to NPN 2N4921, 2N4922, 2N4923
- Pb-Free Package is Available*

MAXIMUM RATINGS

Rating	Symbol	Value	Unit
Collector – Emitter Voltage	V_{CEO}		Vdc
		2N4918	40
		2N4919	60
		2N4920	80
Collector – Base Voltage	V_{CBO}		Vdc
		2N4918	40
		2N4919	60
		2N4920	80
Emitter – Base Voltage	V_{EBO}	5.0	Vdc
Collector Current – Continuous (Note 1)	I_C (Note 2)	1.0	Adc
		3.0	
Base Current	I_B	1.0	Adc
Total Power Dissipation @ $T_A = 25^\circ\text{C}$ Derate above 25°C	P_D	30	W
		0.24	W/ $^\circ\text{C}$
Operating and Storage Junction Temperature Range	T_J, T_{stg}	-65 to +150	$^\circ\text{C}$

Stresses exceeding those listed in the Maximum Ratings table may damage the device. If any of these limits are exceeded, device functionality should not be assumed, damage may occur and reliability may be affected.

1. The 1.0 A max I_C value is based upon JEDEC current gain requirements. The 3.0 A max value is based upon actual current-handling capability of the device (See Figure 5).
2. Indicates JEDEC Registered Data for 2N4918 Series.

THERMAL CHARACTERISTICS (Note 3)

Characteristic	Symbol	Max	Unit
Thermal Resistance, Junction-to-Case	θ_{JC}	4.16	$^\circ\text{C/W}$

3. Recommend use of thermal compound for lowest thermal resistance.

*For additional information on our Pb-Free strategy and soldering details, please download the ON Semiconductor Soldering and Mounting Techniques Reference Manual, SOLDERRM/D.



ON Semiconductor®

<http://onsemi.com>

**3.0 A, 40–80 V, 30 W
GENERAL PURPOSE
POWER TRANSISTORS**

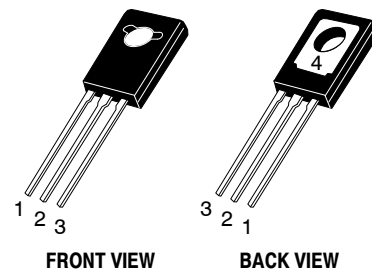

FRONT VIEW

BACK VIEW

TO-225
CASE 077
STYLE 1

MARKING DIAGRAM

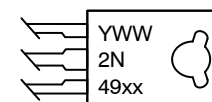

xx = 18, 19, 20
Y = Year
WW = Work Week

ORDERING INFORMATION

See detailed ordering and shipping information on page 2 of this data sheet.

2N4918 – 2N4920 Series

ELECTRICAL CHARACTERISTICS ($T_C = 25^\circ\text{C}$ unless otherwise noted)

Characteristic	Symbol	Min	Max	Unit	
OFF CHARACTERISTICS					
Collector–Emitter Sustaining Voltage (Note 4) ($I_C = 0.1\text{ Adc}$, $I_B = 0$)	2N4918 2N4919 2N4920	$V_{CEO(sus)}$	40 60 80	– – –	Vdc
Collector Cutoff Current ($V_{CE} = 20\text{ Vdc}$, $I_B = 0$) ($V_{CE} = 30\text{ Vdc}$, $I_B = 0$) ($V_{CE} = 40\text{ Vdc}$, $I_B = 0$)	2N4918 2N4919 2N4920	I_{CEO}	– – –	0.5 0.5 0.5	mAdc
Collector Cutoff Current ($V_{CE} = \text{Rated } V_{CEO}$, $V_{BE(off)} = 1.5\text{ Vdc}$) ($V_{CE} = \text{Rated } V_{CEO}$, $V_{BE(off)} = 1.5\text{ Vdc}$, $T_C = 125^\circ\text{C}$)		I_{CEX}	– –	0.1 0.5	mAdc
Collector Cutoff Current ($V_{CB} = \text{Rated } V_{CB}$, $I_E = 0$)		I_{CBO}	–	0.1	mAdc
Emitter Cutoff Current ($V_{BE} = 5.0\text{ Vdc}$, $I_C = 0$)		I_{EBO}	–	1.0	mAdc

ON CHARACTERISTICS

DC Current Gain (Note 4) ($I_C = 50\text{ mAdc}$, $V_{CE} = 1.0\text{ Vdc}$) ($I_C = 500\text{ mAdc}$, $V_{CE} = 1.0\text{ Vdc}$) ($I_C = 1.0\text{ Adc}$, $V_{CE} = 1.0\text{ Vdc}$)	h_{FE}	40 30 10	– 150 –	–
Collector–Emitter Saturation Voltage (Note 4) ($I_C = 1.0\text{ Adc}$, $I_B = 0.1\text{ Adc}$)	$V_{CE(sat)}$	–	0.6	Vdc
Base–Emitter Saturation Voltage (Note 4) ($I_C = 1.0\text{ Adc}$, $I_B = 0.1\text{ Adc}$)	$V_{BE(sat)}$	–	1.3	Vdc
Base–Emitter On Voltage (Note 4) ($I_C = 1.0\text{ Adc}$, $V_{CE} = 1.0\text{ Vdc}$)	$V_{BE(on)}$	–	1.3	Vdc

SMALL-SIGNAL CHARACTERISTICS

Current–Gain – Bandwidth Product ($I_C = 250\text{ mAdc}$, $V_{CE} = 10\text{ Vdc}$, $f = 1.0\text{ MHz}$)	f_T	3.0	–	MHz
Output Capacitance ($V_{CB} = 10\text{ Vdc}$, $I_E = 0$, $f = 100\text{ kHz}$)	C_{ob}	–	100	pF
Small–Signal Current Gain ($I_C = 250\text{ mAdc}$, $V_{CE} = 10\text{ Vdc}$, $f = 1.0\text{ kHz}$)	h_{fe}	25	–	–

4. Pulse Test: $PW \approx 300\ \mu\text{s}$, Duty Cycle $\approx 2.0\%$

ORDERING INFORMATION

Device	Package	Shipping [†]
2N4918	TO–225	500 Unit / Bulk
2N4919	TO–225	500 Unit / Bulk
2N4920	TO–225	500 Unit / Bulk
2N4920G	TO–225 (Pb–Free)	500 Unit / Bulk

[†]For information on tape and reel specifications, including part orientation and tape sizes, please refer to our Tape and Reel Packaging Specifications Brochure, BRD8011/D.

2N4918 – 2N4920 Series

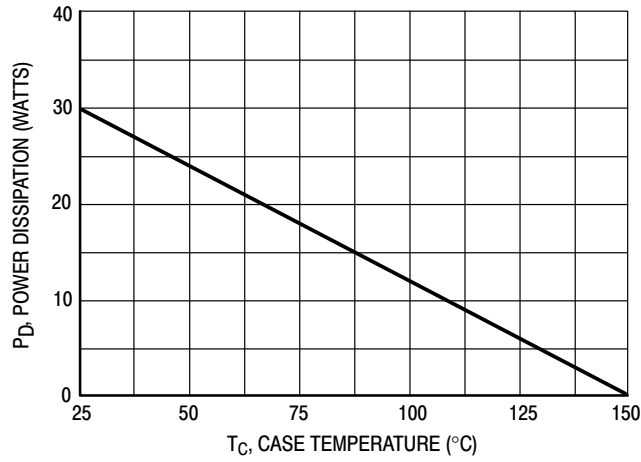

Figure 1. Power Derating

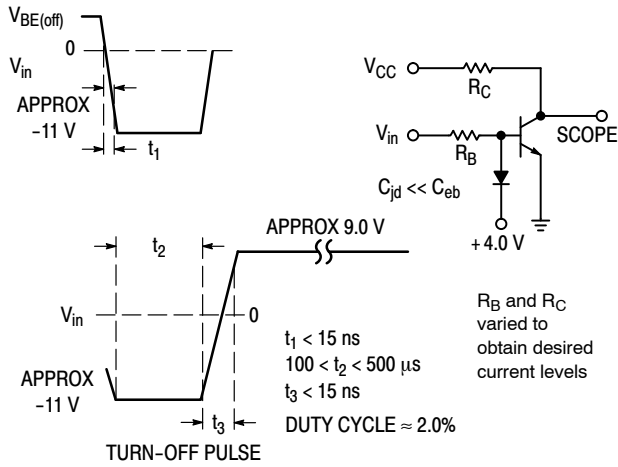

Figure 2. Switching Time Equivalent Test Circuit

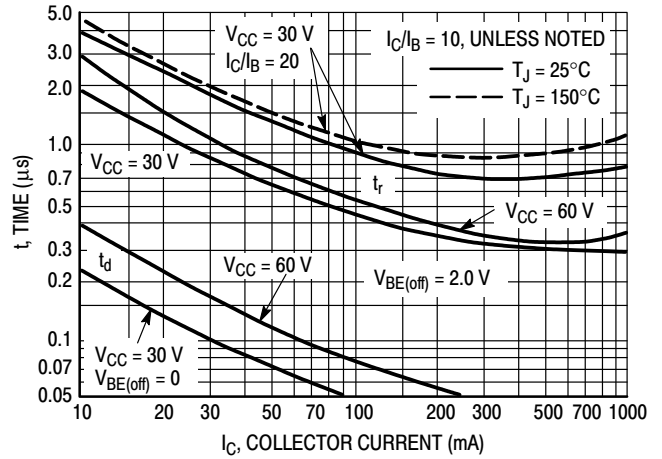

Figure 3. Turn-On Time

2N4918 - 2N4920 Series

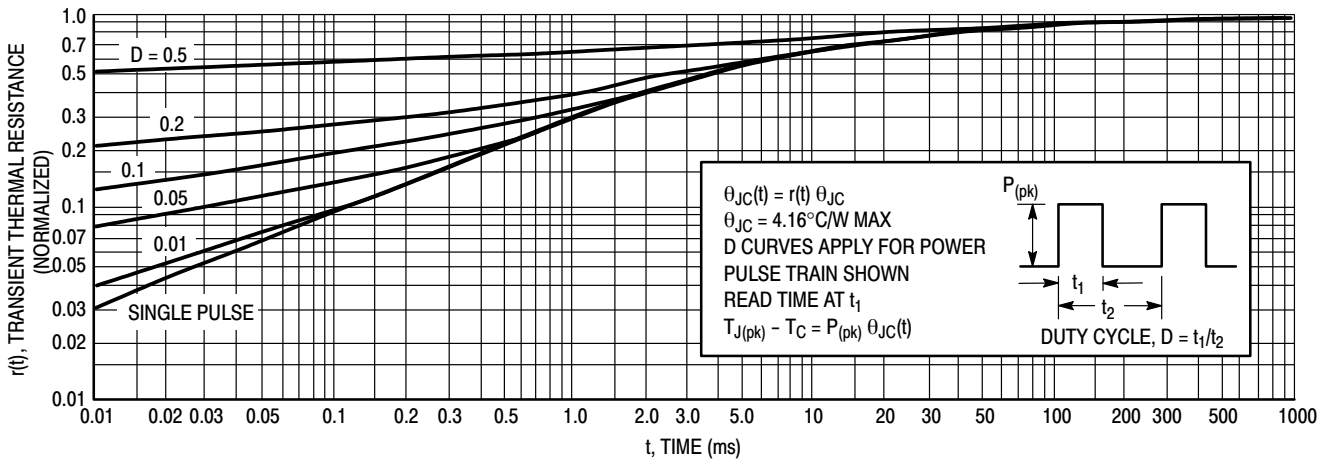

Figure 4. Thermal Response

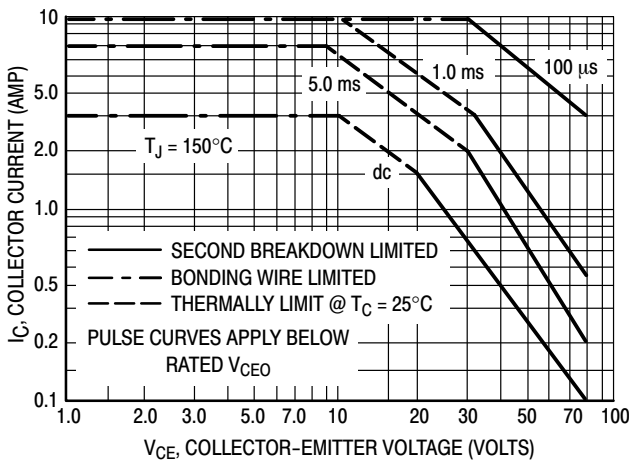

Figure 5. Active-Region Safe Operating Area

There are two limitations on the power handling ability of a transistor: average junction temperature and second breakdown. Safe operating area curves indicate $I_C - V_{CE}$ operation i.e., the transistor must not be subjected to greater dissipation than the curves indicate.

The data of Figure 5 is based on $T_{J(pk)} = 150^\circ\text{C}$; T_C is variable depending on conditions. Second breakdown pulse limits are valid for duty cycles to 10% provided $T_{J(pk)} \leq 150^\circ\text{C}$. At high case temperatures, thermal limitations will reduce the power that can be handled to values less than the limitations imposed by second breakdown.

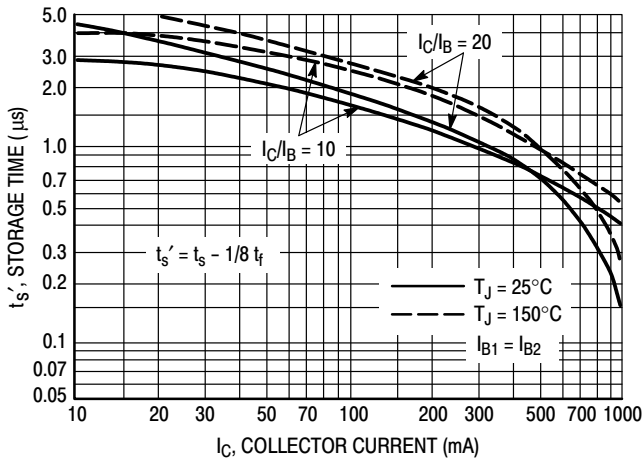

Figure 6. Storage Time

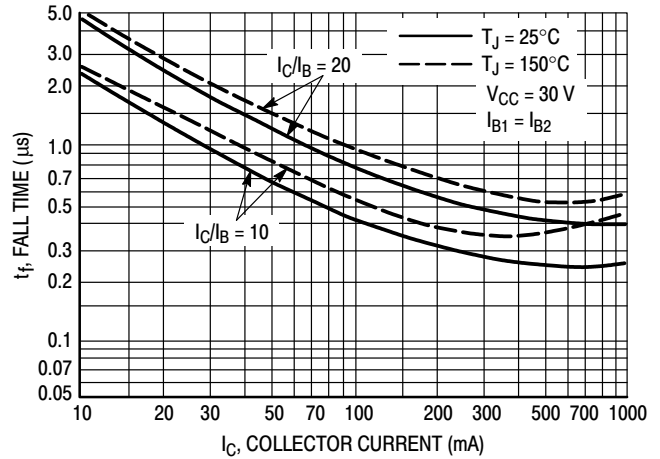

Figure 7. Fall Time

2N4918 – 2N4920 Series

TYPICAL DC CHARACTERISTICS

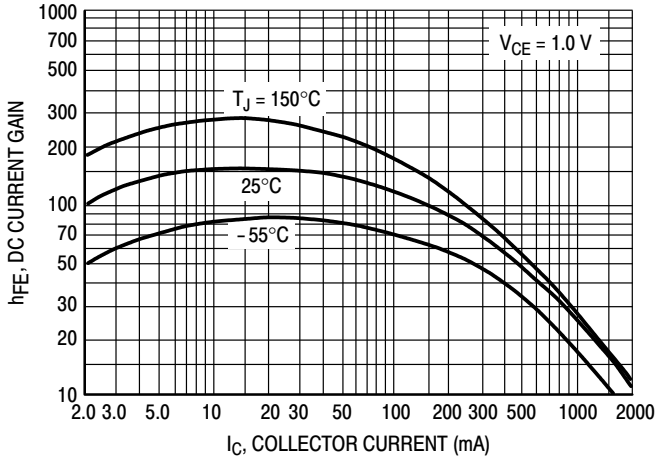

Figure 8. Current Gain

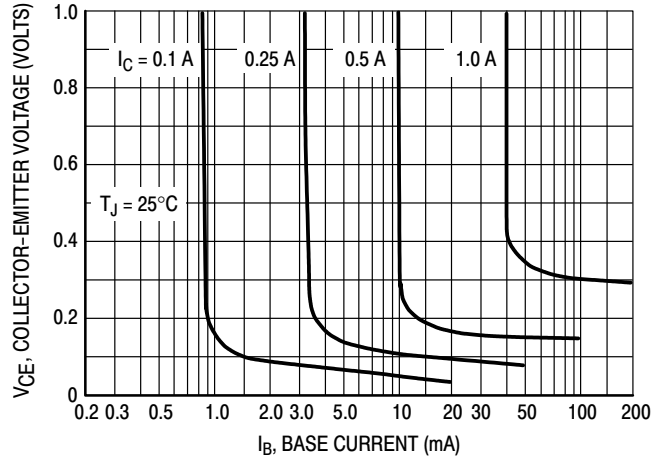

Figure 9. Collector Saturation Region

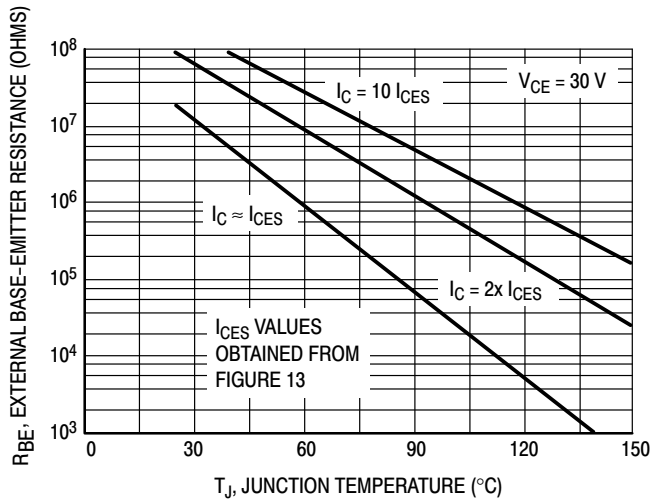

Figure 10. Effects of Base-Emitter Resistance

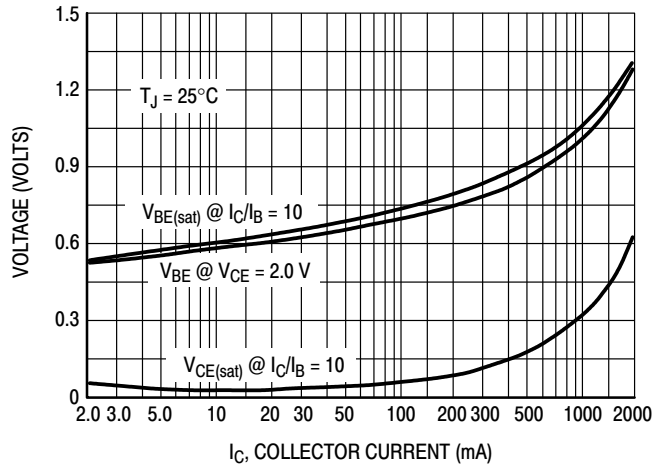

Figure 11. "On" Voltage

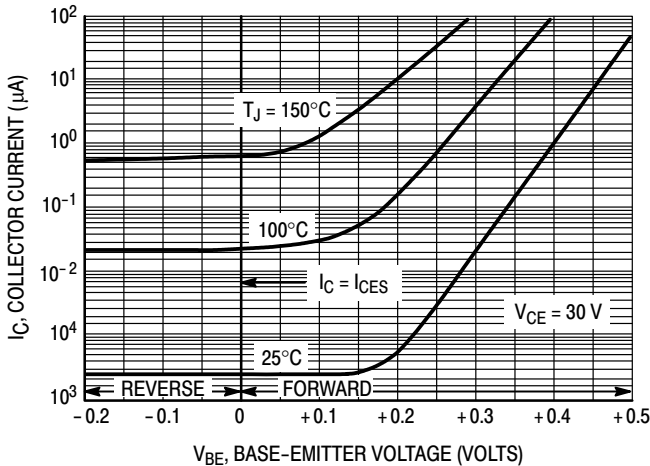

Figure 12. Collector Cut-Off Region

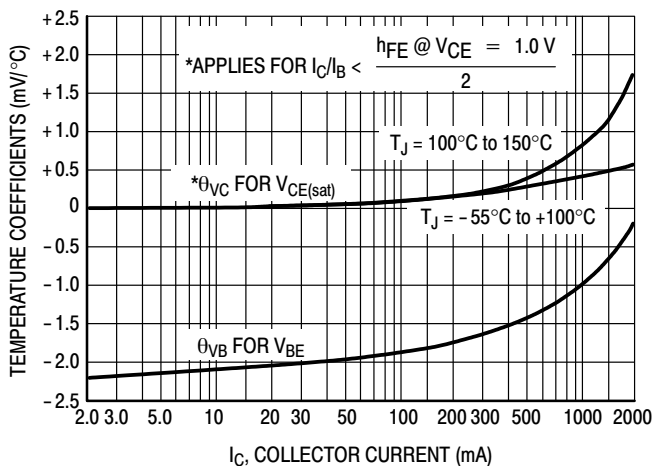
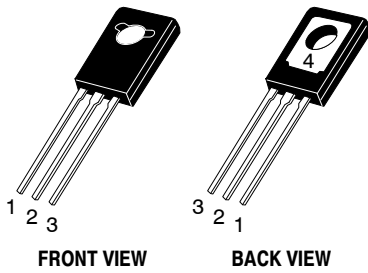

Figure 13. Temperature Coefficients

MECHANICAL CASE OUTLINE

PACKAGE DIMENSIONS

ON Semiconductor®



TO-225
CASE 77-09
ISSUE AD

DATE 25 MAR 2015

SCALE 1:1

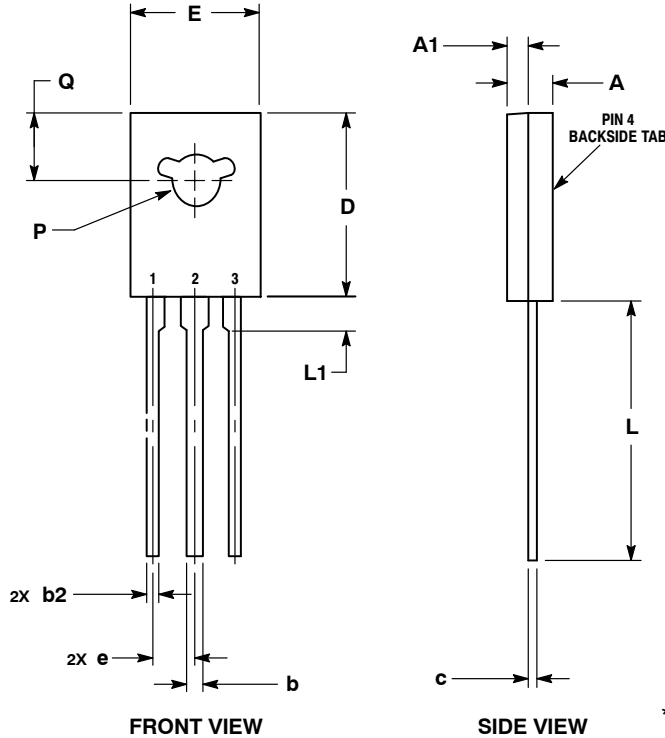

NOTES:

1. DIMENSIONING AND TOLERANCING PER ASME Y14.5M, 1994.
2. CONTROLLING DIMENSION: MILLIMETERS.
3. NUMBER AND SHAPE OF LUGS OPTIONAL.

DIM	MILLIMETERS	
	MIN	MAX
A	2.40	3.00
A1	1.00	1.50
b	0.60	0.90
b2	0.51	0.88
c	0.39	0.63
D	10.60	11.10
E	7.40	7.80
e	2.04	2.54
L	14.50	16.63
L1	1.27	2.54
P	2.90	3.30
Q	3.80	4.20

GENERIC MARKING DIAGRAM*

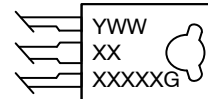

- Y = Year
- WW = Work Week
- XXXXX = Device Code
- G = Pb-Free Package

*This information is generic. Please refer to device data sheet for actual part marking. Pb-Free indicator, "G" or microdot "•", may or may not be present.

- | | | | | |
|---|---|---|---|---|
| <p>STYLE 1:
PIN 1. EMITTER
2., 4. COLLECTOR
3. BASE</p> | <p>STYLE 2:
PIN 1. CATHODE
2., 4. ANODE
3. GATE</p> | <p>STYLE 3:
PIN 1. BASE
2., 4. COLLECTOR
3. EMITTER</p> | <p>STYLE 4:
PIN 1. ANODE 1
2., 4. ANODE 2
3. GATE</p> | <p>STYLE 5:
PIN 1. MT 1
2., 4. MT 2
3. GATE</p> |
| <p>STYLE 6:
PIN 1. CATHODE
2., 4. GATE
3. ANODE</p> | <p>STYLE 7:
PIN 1. MT 1
2., 4. GATE
3. MT 2</p> | <p>STYLE 8:
PIN 1. SOURCE
2., 4. GATE
3. DRAIN</p> | <p>STYLE 9:
PIN 1. GATE
2., 4. DRAIN
3. SOURCE</p> | <p>STYLE 10:
PIN 1. SOURCE
2., 4. DRAIN
3. GATE</p> |

DOCUMENT NUMBER:	98ASB42049B	Electronic versions are uncontrolled except when accessed directly from the Document Repository. Printed versions are uncontrolled except when stamped "CONTROLLED COPY" in red.
DESCRIPTION:	TO-225	PAGE 1 OF 1

ON Semiconductor and are trademarks of Semiconductor Components Industries, LLC dba ON Semiconductor or its subsidiaries in the United States and/or other countries. ON Semiconductor reserves the right to make changes without further notice to any products herein. ON Semiconductor makes no warranty, representation or guarantee regarding the suitability of its products for any particular purpose, nor does ON Semiconductor assume any liability arising out of the application or use of any product or circuit, and specifically disclaims any and all liability, including without limitation special, consequential or incidental damages. ON Semiconductor does not convey any license under its patent rights nor the rights of others.

onsemi, **Onsemi**, and other names, marks, and brands are registered and/or common law trademarks of Semiconductor Components Industries, LLC dba "**onsemi**" or its affiliates and/or subsidiaries in the United States and/or other countries. **onsemi** owns the rights to a number of patents, trademarks, copyrights, trade secrets, and other intellectual property. A listing of **onsemi**'s product/patent coverage may be accessed at www.onsemi.com/site/pdf/Patent-Marking.pdf. **onsemi** reserves the right to make changes at any time to any products or information herein, without notice. The information herein is provided "as-is" and **onsemi** makes no warranty, representation or guarantee regarding the accuracy of the information, product features, availability, functionality, or suitability of its products for any particular purpose, nor does **onsemi** assume any liability arising out of the application or use of any product or circuit, and specifically disclaims any and all liability, including without limitation special, consequential or incidental damages. Buyer is responsible for its products and applications using **onsemi** products, including compliance with all laws, regulations and safety requirements or standards, regardless of any support or applications information provided by **onsemi**. "Typical" parameters which may be provided in **onsemi** data sheets and/or specifications can and do vary in different applications and actual performance may vary over time. All operating parameters, including "Typicals" must be validated for each customer application by customer's technical experts. **onsemi** does not convey any license under any of its intellectual property rights nor the rights of others. **onsemi** products are not designed, intended, or authorized for use as a critical component in life support systems or any FDA Class 3 medical devices or medical devices with a same or similar classification in a foreign jurisdiction or any devices intended for implantation in the human body. Should Buyer purchase or use **onsemi** products for any such unintended or unauthorized application, Buyer shall indemnify and hold **onsemi** and its officers, employees, subsidiaries, affiliates, and distributors harmless against all claims, costs, damages, and expenses, and reasonable attorney fees arising out of, directly or indirectly, any claim of personal injury or death associated with such unintended or unauthorized use, even if such claim alleges that **onsemi** was negligent regarding the design or manufacture of the part. **onsemi** is an Equal Opportunity/Affirmative Action Employer. This literature is subject to all applicable copyright laws and is not for resale in any manner.

PUBLICATION ORDERING INFORMATION

LITERATURE FULFILLMENT:

Email Requests to: orderlit@onsemi.com

onsemi Website: www.onsemi.com

TECHNICAL SUPPORT

North American Technical Support:
Voice Mail: 1 800-282-9855 Toll Free USA/Canada
Phone: 011 421 33 790 2910

Europe, Middle East and Africa Technical Support:

Phone: 00421 33 790 2910

For additional information, please contact your local Sales Representative