

NCP551, NCV551

Voltage Regulator - CMOS, Low Iq, Low-Dropout

150 mA

The NCP551 series of fixed output low dropout linear regulators are designed for handheld communication equipment and portable battery powered applications which require low quiescent. The NCP551 series features an ultra-low quiescent current of 4.0 μ A. Each device contains a voltage reference unit, an error amplifier, a PMOS power transistor, resistors for setting output voltage, current limit, and temperature limit protection circuits.

The NCP551 has been designed to be used with low cost ceramic capacitors and requires a minimum output capacitor of 0.1 μ F. The device is housed in the TSOP-5 surface mount package. Standard voltage versions are 1.4, 1.5, 1.8, 2.5, 2.7, 2.8, 2.9, 3.0, 3.1, 3.2, 3.3, 3.6, 3.8 and 5.0 V. Other voltages are available in 100 mV steps.

Features

- Low Quiescent Current of 4.0 μ A Typical
- Maximum Operating Voltage of 12 V
- Low Output Voltage Option
- High Accuracy Output Voltage of 2.0%
- Industrial Temperature Range of -40°C to 85°C (NCV551, $T_A = -40^{\circ}\text{C}$ to $+125^{\circ}\text{C}$)
- NCV Prefix for Automotive and Other Applications Requiring Unique Site and Control Change Requirements; AEC-Q100 Qualified and PPAP Capable
- These Devices are Pb-Free and are RoHS Compliant

Typical Applications

- Battery Powered Instruments
- Hand-Held Instruments
- Camcorders and Cameras

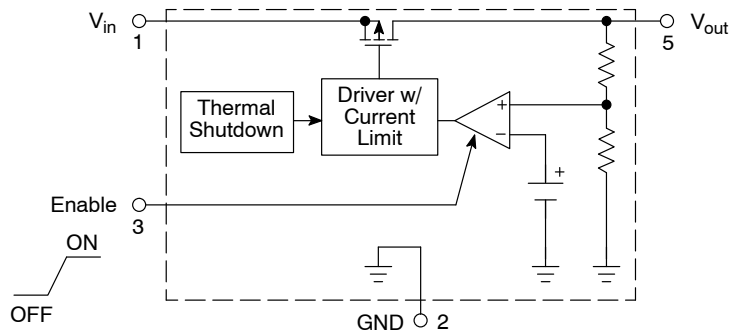

Figure 1. Representative Block Diagram



ON Semiconductor®

www.onsemi.com



TSOP-5
(SOT23-5, SC59-5)
SN SUFFIX
CASE 483

PIN CONNECTIONS AND MARKING DIAGRAM

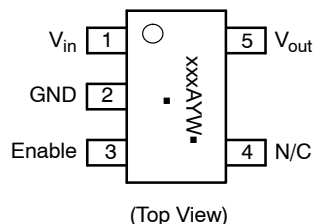

xxx = Specific Device Code
A = Assembly Location
Y = Year
W = Work Week
▪ = Pb-Free Package
(Note: Microdot may be in either location)

ORDERING INFORMATION

See detailed ordering and shipping information in the package dimensions section on page 11 of this data sheet.

NCP551, NCV551

PIN FUNCTION DESCRIPTION

Pin No.	Pin Name	Description
1	V _{in}	Positive power supply input voltage.
2	GND	Power supply ground.
3	Enable	This input is used to place the device into low-power standby. When this input is pulled low, the device is disabled. If this function is not used, Enable should be connected to V _{in} .
4	N/C	No Internal Connection.
5	V _{out}	Regulated output voltage.

MAXIMUM RATINGS

Rating	Symbol	Value	Unit
Input Voltage	V _{in}	0 to 12	V
Enable Voltage	V _{EN}	-0.3 to V _{in} +0.3	V
Output Voltage	V _{out}	-0.3 to V _{in} +0.3	V
Power Dissipation	P _D	Internally Limited	W
Operating Junction Temperature	T _J	+150	°C
Operating Ambient Temperature	T _A	NCP551 -40 to +85 NCV551 -40 to +125	°C
Storage Temperature	T _{stg}	-55 to +150	°C

Stresses exceeding those listed in the Maximum Ratings table may damage the device. If any of these limits are exceeded, device functionality should not be assumed, damage may occur and reliability may be affected.

- This device series contains ESD protection and exceeds the following tests:
 - Human Body Model 2000 V per MIL-STD-883, Method 3015
 - Machine Model Method 200 V
 - Charge Device Model (CDM) tested C3B per EIA/JESD22-C101.
- Latchup capability (85°C) ± 100 mA DC with trigger voltage.

THERMAL CHARACTERISTICS

Rating	Symbol	Test Conditions	Typical Value	Unit
Junction-to-Ambient	R _{θJA}	1 oz Copper Thickness, 100 mm ²	250	°C/W
PSIJ-Lead 2	Ψ _{J-L2}	1 oz Copper Thickness, 100 mm ²	68	°C/W

NOTE: Single component mounted on an 80 x 80 x 1.5 mm FR4 PCB with stated copper head spreading area. Using the following boundary conditions as stated in EIA/JESD 51-1, 2, 3, 7, 12.

NCP551, NCV551

ELECTRICAL CHARACTERISTICS

($V_{in} = V_{out(nom.)} + 1.0\text{ V}$, $V_{EN} = V_{in}$, $C_{in} = 1.0\ \mu\text{F}$, $C_{out} = 1.0\ \mu\text{F}$, $T_A = 25^\circ\text{C}$, unless otherwise noted.)

Characteristic	Symbol	Min	Typ	Max	Unit
Output Voltage ($T_A = 25^\circ\text{C}$, $I_{out} = 10\text{ mA}$) 1.4 V 1.5 V 1.8 V 2.5 V 2.7 V 2.8 V 2.9 V 3.0 V 3.1 V 3.2 V 3.3 V 3.6 V 3.8 V 5.0 V	V_{out}	1.358 1.455 1.746 2.425 2.646 2.744 2.842 2.940 3.038 3.136 3.234 3.528 3.724 4.90	1.4 1.5 1.8 2.5 2.7 2.8 2.9 3.0 3.1 3.2 3.3 3.6 3.8 5.0	1.442 1.545 1.854 2.575 2.754 2.856 2.958 3.060 3.162 3.264 3.366 3.672 3.876 5.10	V
Output Voltage ($T_A = T_{low}$ to T_{high} , $I_{out} = 10\text{ mA}$) 1.4 V 1.5 V 1.8 V 2.5 V 2.7 V 2.8 V 2.9 V 3.0 V 3.1 V 3.2 V 3.3 V 3.6 V 3.8 V 5.0 V	V_{out}	1.344 1.440 1.728 2.400 2.619 2.716 2.813 2.910 3.007 3.104 3.201 3.492 3.686 4.850	1.4 1.5 1.8 2.5 2.7 2.8 2.9 3.0 3.1 3.2 3.3 3.6 3.8 5.0	1.456 1.560 1.872 2.600 2.781 2.884 2.987 3.090 3.193 3.296 3.399 3.708 3.914 5.150	V
Line Regulation ($V_{in} = V_{out} + 1.0\text{ V}$ to 12 V , $I_{out} = 10\text{ mA}$)	Reg_{line}	-	10	30	mV
Load Regulation ($I_{out} = 10\text{ mA}$ to 150 mA , $V_{in} = V_{out} + 2.0\text{ V}$)	Reg_{load}	-	40	65	mV
Output Current ($V_{out} = (V_{out}$ at $I_{out} = 100\text{ mA}) - 3\%$) 1.4 V–2.0 V ($V_{in} = 4.0\text{ V}$) 2.1 V–3.0 V ($V_{in} = 5.0\text{ V}$) 3.1 V–4.0 V ($V_{in} = 6.0\text{ V}$) 4.1 V–5.0 V ($V_{in} = 8.0\text{ V}$)	$I_{o(nom.)}$	150 150 150 150	- - - -	- - - -	mA
Dropout Voltage ($I_{out} = 10\text{ mA}$, Measured at $V_{out} - 3.0\%$) 1.4 V 1.5 V, 1.8 V, 2.5 V 2.7 V, 2.8 V, 2.9 V, 3.0 V, 3.1 V, 3.2 V, 3.3 V, 3.6 V, 3.8 V, 5.0 V	$V_{in} - V_{out}$	- - -	170 130 40	250 220 150	mV
Quiescent Current (Enable Input = 0 V) (Enable Input = V_{in} , $I_{out} = 1.0\text{ mA}$ to $I_{o(nom.)}$) 1.4 V–2.0 V options, $V_{in} = 4.0\text{ V}$ 2.1 V–3.0 V options, $V_{in} = 5.0\text{ V}$ 3.1 V–4.0 V options, $V_{in} = 6.0\text{ V}$ 4.1 V–5.0 V options, $V_{in} = 8.0\text{ V}$	I_Q	- -	0.1 4.0	1.0 8.0	μA
Output Voltage Temperature Coefficient	T_c	-	± 100	-	ppm/ $^\circ\text{C}$
Enable Input Threshold Voltage (Voltage Increasing, Output Turns On, Logic High) (Voltage Decreasing, Output Turns Off, Logic Low)	$V_{th(en)}$	1.3 -	- -	- 0.3	V

NCP551, NCV551

ELECTRICAL CHARACTERISTICS (continued)

($V_{in} = V_{out(nom.)} + 1.0\text{ V}$, $V_{EN} = V_{in}$, $C_{in} = 1.0\ \mu\text{F}$, $C_{out} = 1.0\ \mu\text{F}$, $T_A = 25^\circ\text{C}$, unless otherwise noted.)

Output Short Circuit Current ($V_{out} = 0\text{ V}$)	$I_{out(max)}$				mA
1.4 V–2.0 V ($V_{in} = 4.0\text{ V}$)		160	350	600	
2.1 V–3.0 V ($V_{in} = 5.0\text{ V}$)		160	350	600	
3.1 V–4.0 V ($V_{in} = 6.0\text{ V}$)		160	350	600	
4.1 V–5.0 V ($V_{in} = 8.0\text{ V}$)		160	350	600	

3. Maximum package power dissipation limits must be observed.

$$PD = \frac{T_J(max) - T_A}{R_{\theta JA}}$$

4. Low duty cycle pulse techniques are used during testing to maintain the junction temperature as close to ambient as possible.
5. NCP551 $T_{low} = -40^\circ\text{C}$ $T_{high} = +85^\circ\text{C}$
 NCV551 $T_{low} = -40^\circ\text{C}$ $T_{high} = +125^\circ\text{C}$.

DEFINITIONS

Load Regulation

The change in output voltage for a change in output current at a constant temperature.

Dropout Voltage

The input/output differential at which the regulator output no longer maintains regulation against further reductions in input voltage. Measured when the output drops 3% below its nominal. The junction temperature, load current, and minimum input supply requirements affect the dropout level.

Maximum Power Dissipation

The maximum total dissipation for which the regulator will operate within its specifications.

Quiescent Current

The quiescent current is the current which flows through the ground when the LDO operates without a load on its output: internal IC operation, bias, etc. When the LDO becomes loaded, this term is called the Ground current. It is actually the difference between the input current (measured through the LDO input pin) and the output current.

Line Regulation

The change in output voltage for a change in input voltage. The measurement is made under conditions of low dissipation or by using pulse technique such that the average chip temperature is not significantly affected.

Line Transient Response

Typical over and undershoot response when input voltage is excited with a given slope.

Thermal Protection

Internal thermal shutdown circuitry is provided to protect the integrated circuit in the event that the maximum junction temperature is exceeded. When activated at typically 160°C, the regulator turns off. This feature is provided to prevent failures from accidental overheating.

Maximum Package Power Dissipation

The maximum power package dissipation is the power dissipation level at which the junction temperature reaches its maximum operating value, i.e. 125°C. Depending on the ambient power dissipation and thus the maximum available output current.

NCP551, NCV551

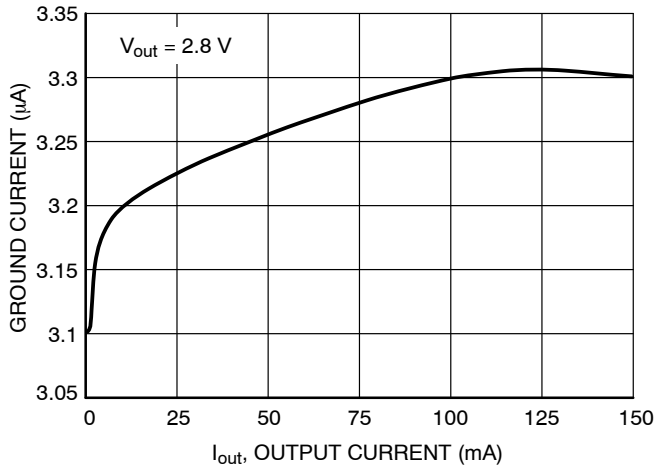

Figure 2. Ground Pin Current versus Output Current

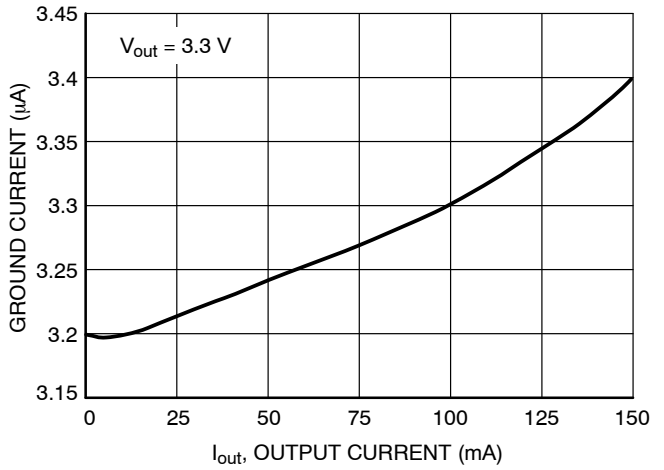

Figure 3. Ground Pin Current versus Output Current

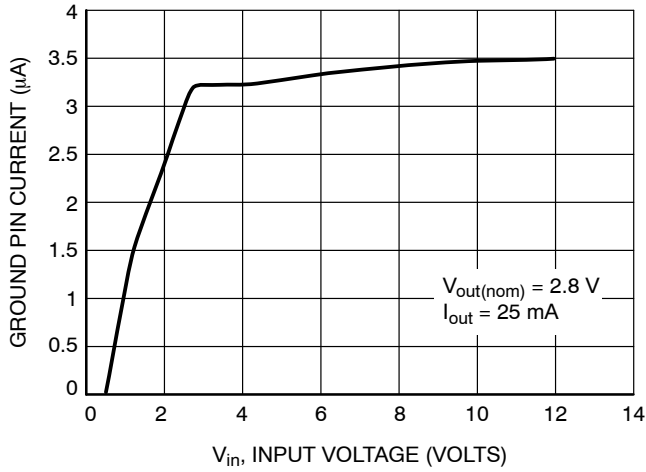

Figure 4. Ground Pin Current versus Input Voltage

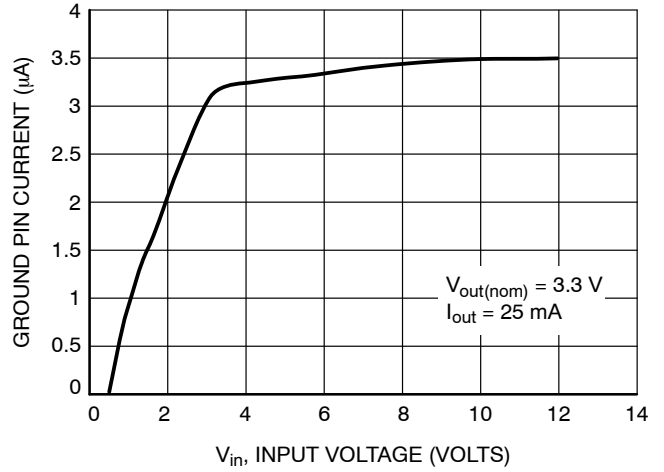

Figure 5. Ground Pin Current versus Input Voltage

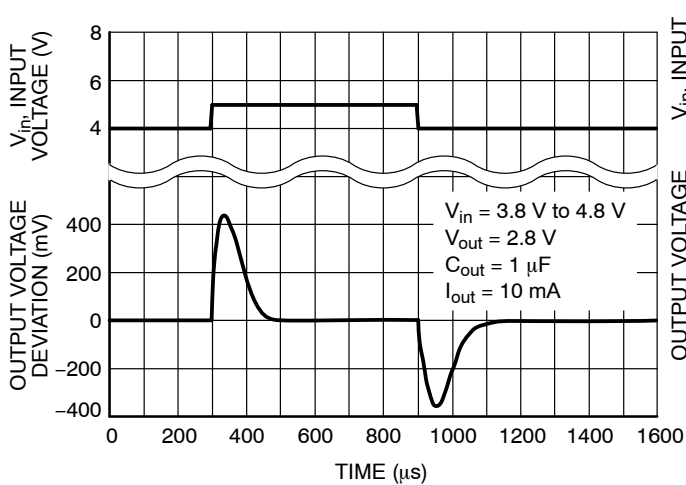

Figure 6. Line Transient Response

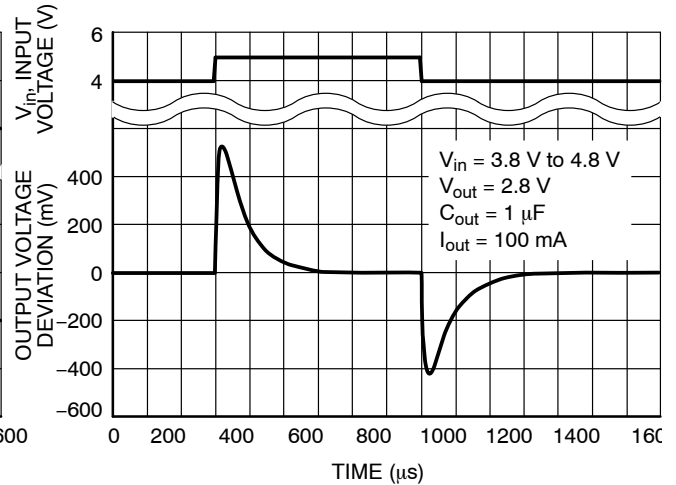

Figure 7. Line Transient Response

NCP551, NCV551

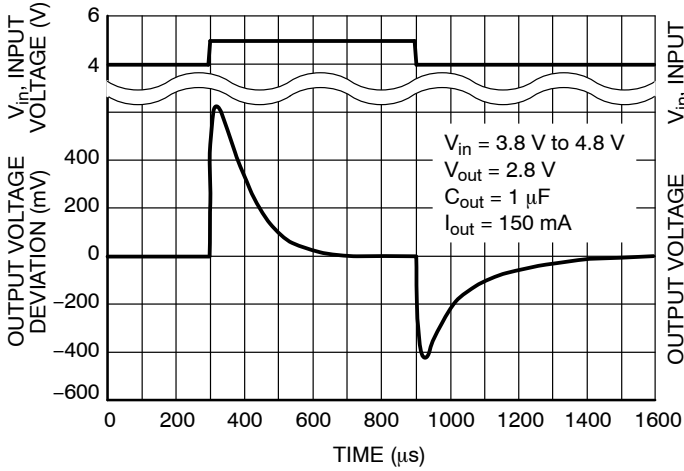

Figure 8. Line Transient Response

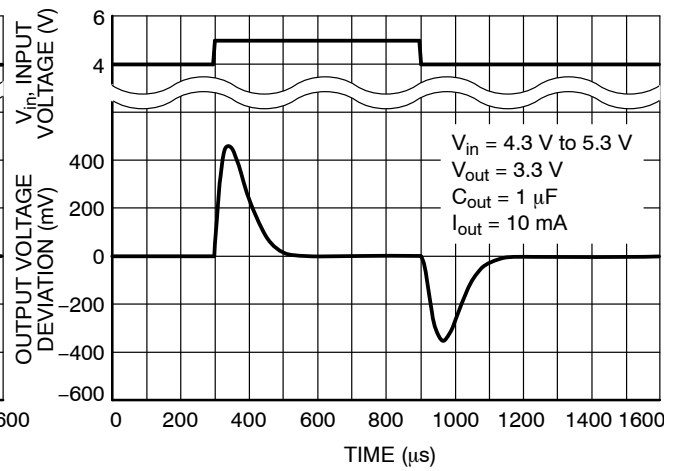

Figure 9. Line Transient Response

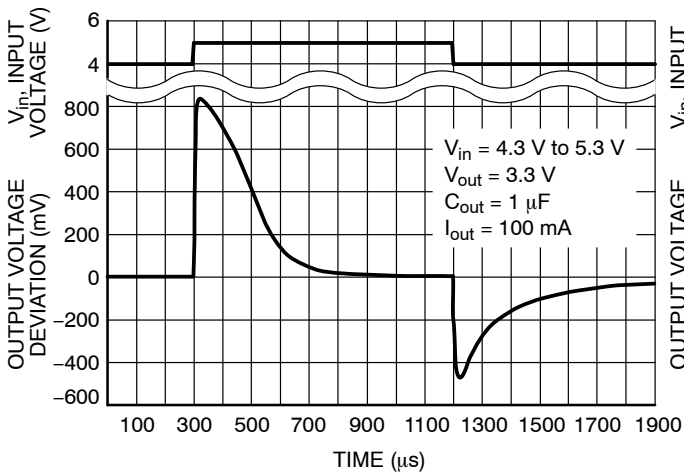

Figure 10. Line Transient Response

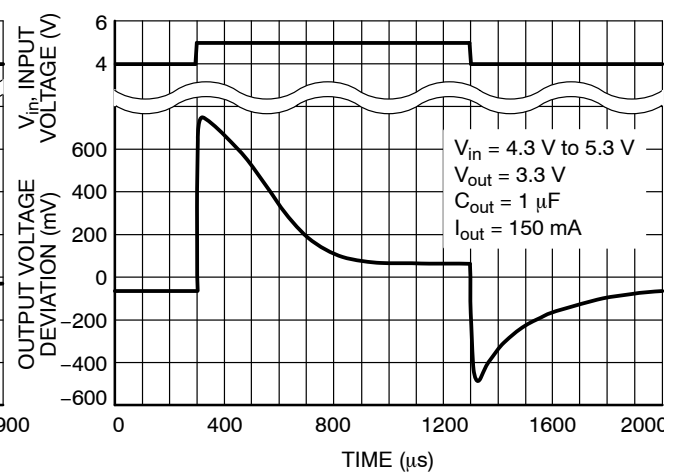

Figure 11. Line Transient Response

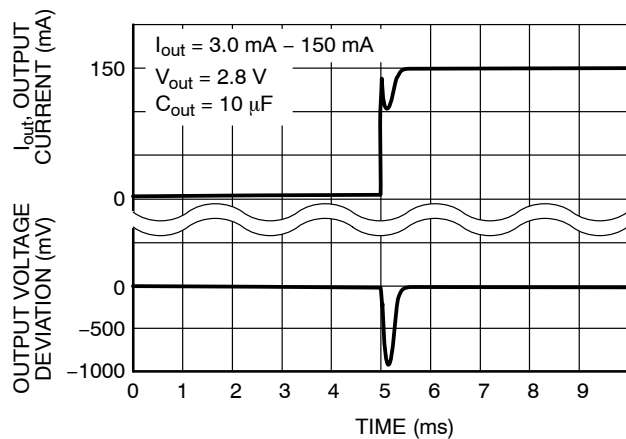

Figure 12. Load Transient Response ON

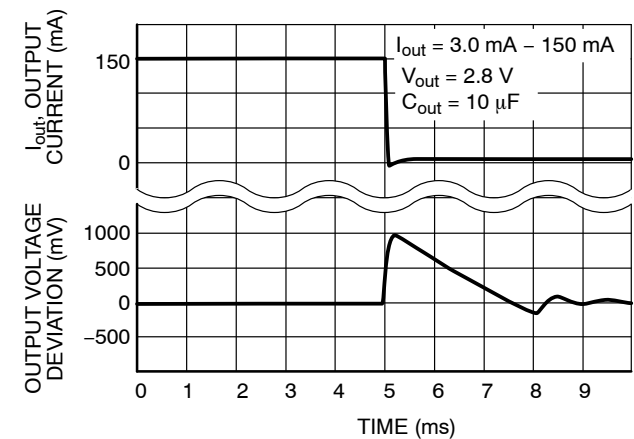

Figure 13. Load Transient Response OFF

NCP551, NCV551

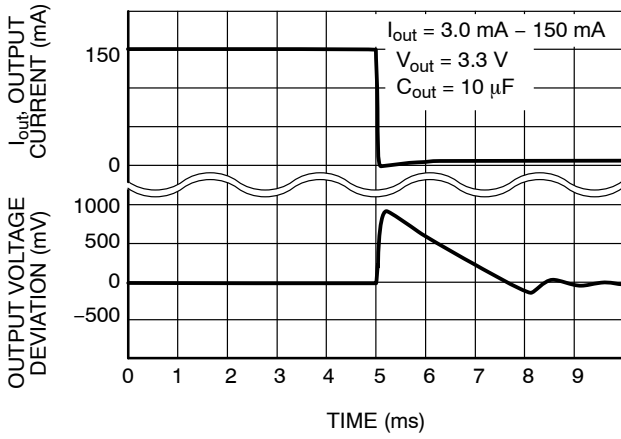

Figure 14. Load Transient Response OFF

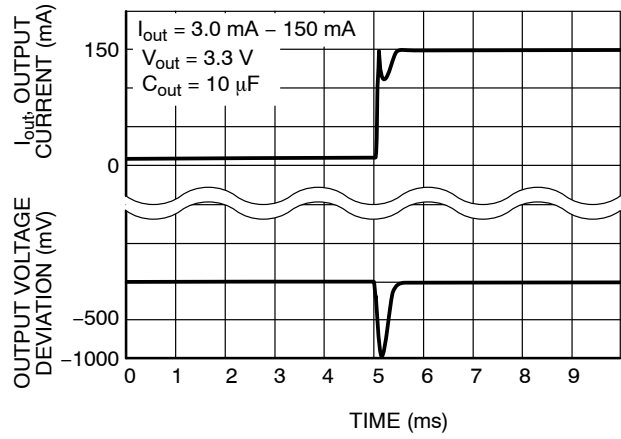

Figure 15. Load Transient Response ON

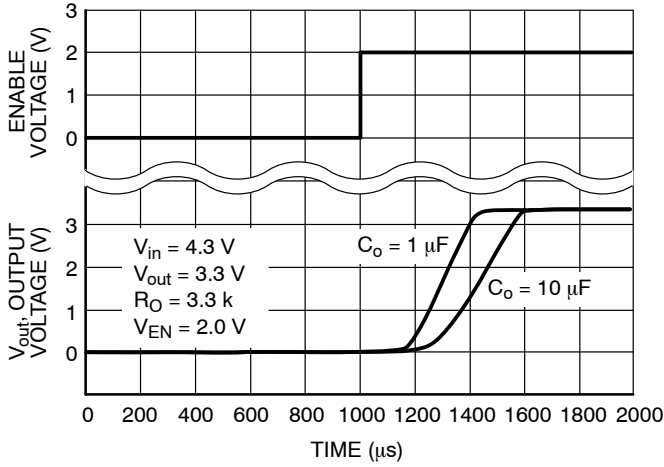

Figure 16. Turn-On Response

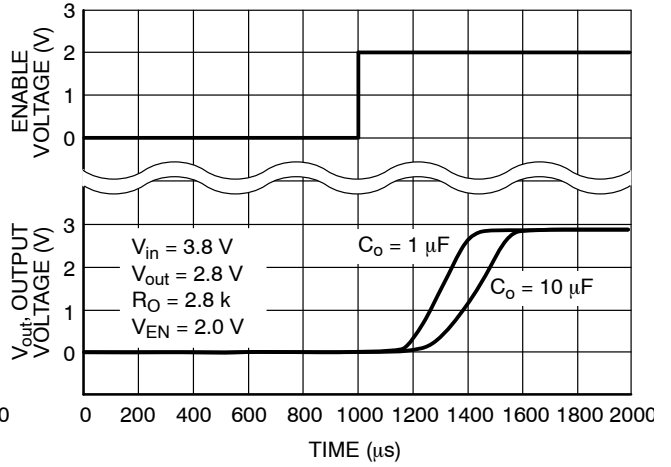

Figure 17. Turn-On Response

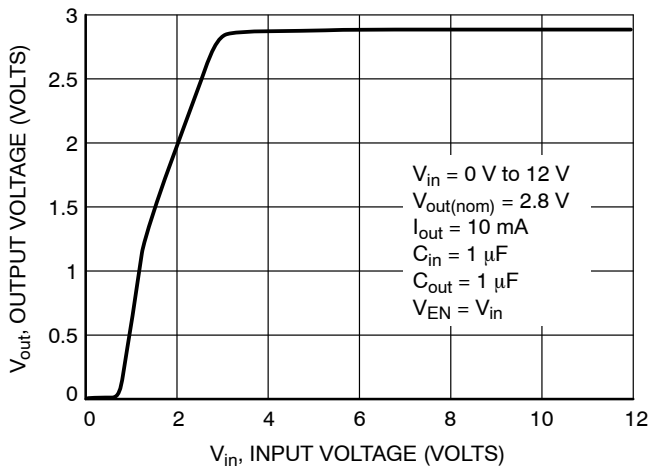

Figure 18. Output Voltage versus Input Voltage

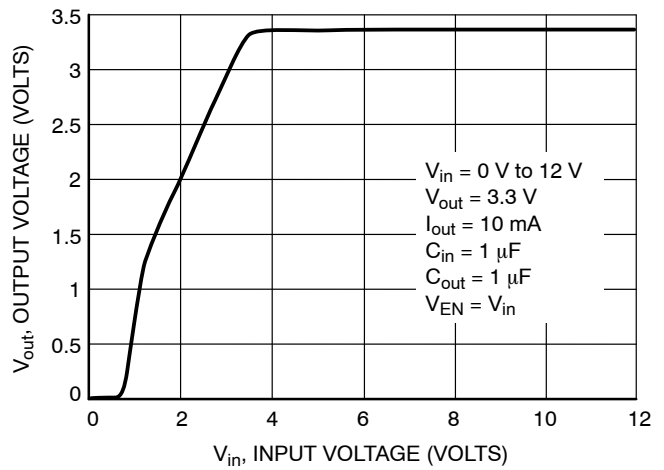

Figure 19. Output Voltage versus Input Voltage

NCP551, NCV551

APPLICATIONS INFORMATION

A typical application circuit for the NCP551 series is shown in Figure 20.

Input Decoupling (C1)

A 0.1 μF capacitor either ceramic or tantalum is recommended and should be connected close to the NCP551 package. Higher values and lower ESR will improve the overall line transient response.

Output Decoupling (C2)

The NCP551 is a stable Regulator and does not require any specific Equivalent Series Resistance (ESR) or a minimum output current. Capacitors exhibiting ESRs ranging from a few $\text{m}\Omega$ up to 3.0Ω can thus safely be used. The minimum decoupling value is 0.1 μF and can be augmented to fulfill stringent load transient requirements. The regulator accepts ceramic chip capacitors as well as tantalum devices. Larger values improve noise rejection and load regulation transient response.

Enable Operation

The enable pin will turn on or off the regulator. These limits of threshold are covered in the electrical specification section of this data sheet. If the enable is not used then the pin should be connected to V_{in} .

Hints

Please be sure the V_{in} and GND lines are sufficiently wide. When the impedance of these lines is high, there is a chance to pick up noise or cause the regulator to malfunction.

Set external components, especially the output capacitor, as close as possible to the circuit, and make leads as short as possible.

Thermal

As power across the NCP551 increases, it might become necessary to provide some thermal relief. The maximum power dissipation supported by the device is dependent upon board design and layout. Mounting pad configuration on the PCB, the board material, and also the ambient temperature effect the rate of temperature rise for the part. This is stating that when the NCP551 has good thermal conductivity through the PCB, the junction temperature will be relatively low with high power dissipation applications.

The maximum dissipation the package can handle is given by:

$$PD = \frac{T_{J(\text{max})} - T_A}{R_{\theta JA}}$$

If junction temperature is not allowed above the maximum 125°C , then the NCP551 can dissipate up to 400 mW @ 25°C .

The power dissipated by the NCP551 can be calculated from the following equation:

$$P_{\text{tot}} = [V_{\text{in}} * I_{\text{gnd}} (I_{\text{out}})] + [V_{\text{in}} - V_{\text{out}}] * I_{\text{out}}$$

or

$$V_{\text{inMAX}} = \frac{P_{\text{tot}} + V_{\text{out}} * I_{\text{out}}}{I_{\text{GND}} + I_{\text{out}}}$$

If a 150 mA output current is needed then the ground current from the data sheet is $4.0 \mu\text{A}$. For an NCP551SN30T1 (3.0 V), the maximum input voltage will then be 5.6 V.

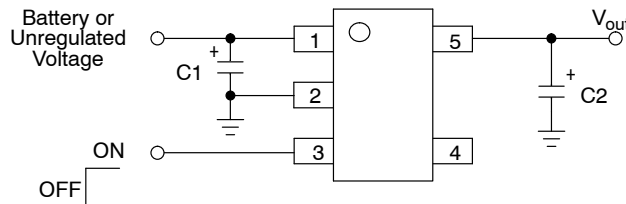

Figure 20. Typical Application Circuit

NCP551, NCV551

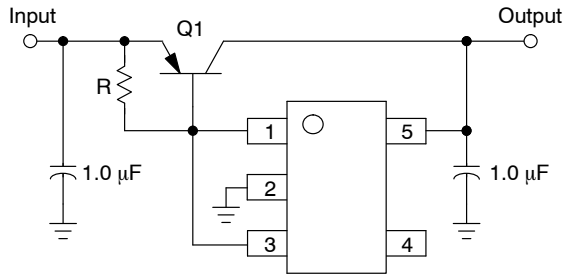

Figure 21. Current Boost Regulator

The NCP551 series can be current boosted with a PNP transistor. Resistor R in conjunction with V_{BE} of the PNP determines when the pass transistor begins conducting; this circuit is not short circuit proof. Input/Output differential voltage minimum is increased by V_{BE} of the pass resistor.

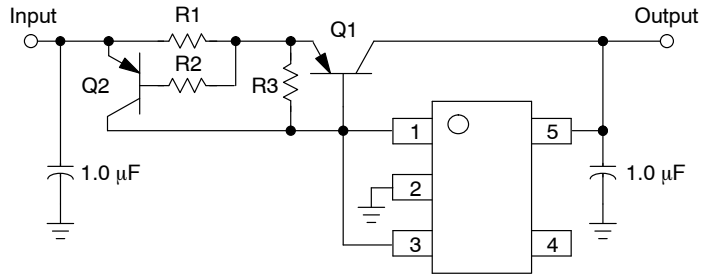

Figure 22. Current Boost Regulator with Short Circuit Limit

Short circuit current limit is essentially set by the V_{BE} of Q2 and R1. $I_{SC} = ((V_{BEQ2} - i_b * R2) / R1) + I_{O(max) \text{ Regulator}}$

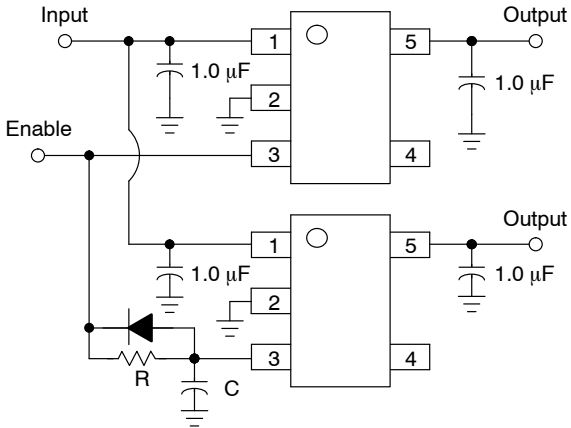

Figure 23. Delayed Turn-on

If a delayed turn-on is needed during power up of several voltages then the above schematic can be used. Resistor R, and capacitor C, will delay the turn-on of the bottom regulator.

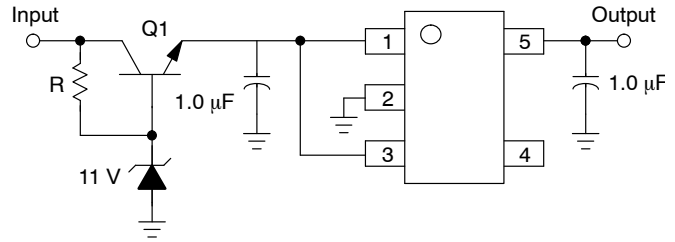

Figure 24. Input Voltages Greater than 12 V

A regulated output can be achieved with input voltages that exceed the 12 V maximum rating of the NCP551 series with the addition of a simple pre-regulator circuit. Care must be taken to prevent Q1 from overheating when the regulated output (V_{out}) is shorted to GND.

NCP551, NCV551

ORDERING INFORMATION

Device	Nominal Output Voltage	Marking	Package	Shipping†
NCP551SN15T1G	1.5	LAO	TSOP-5 (Pb-Free)	3000 / Tape & Reel
NCP551SN18T1G	1.8	LAP	TSOP-5 (Pb-Free)	3000 / Tape & Reel
NCP551SN25T1G	2.5	LAQ	TSOP-5 (Pb-Free)	3000 / Tape & Reel
NCP551SN27T1G	2.7	LAR	TSOP-5 (Pb-Free)	3000 / Tape & Reel
NCP551SN28T1G	2.8	LAS	TSOP-5 (Pb-Free)	3000 / Tape & Reel
NCP551SN29T1G	2.9	LJL	TSOP-5 (Pb-Free)	3000 / Tape & Reel
NCP551SN30T1G	3.0	LAT	TSOP-5 (Pb-Free)	3000 / Tape & Reel
NCP551SN31T1G	3.1	LJM	TSOP-5 (Pb-Free)	3000 / Tape & Reel
NCP551SN32T1G	3.2	LIV	TSOP-5 (Pb-Free)	3000 / Tape & Reel
NCP551SN33T1G	3.3	LAU	TSOP-5 (Pb-Free)	3000 / Tape & Reel
NCP551SN50T1G	5.0	LAV	TSOP-5 (Pb-Free)	3000 / Tape & Reel
NCV551SN14T1G*	1.4	AAT	TSOP-5 (Pb-Free)	3000 / Tape & Reel
NCV551SN15T1G*	1.5	LFZ	TSOP-5 (Pb-Free)	3000 / Tape & Reel
NCV551SN18T1G*	1.8	LGA	TSOP-5 (Pb-Free)	3000 / Tape & Reel
NCV551SN25T1G*	2.5	LGB	TSOP-5 (Pb-Free)	3000 / Tape & Reel
NCV551SN27T1G*	2.7	LGC	TSOP-5 (Pb-Free)	3000 / Tape & Reel
NCV551SN28T1G*	2.8	LGD	TSOP-5 (Pb-Free)	3000 / Tape & Reel
NCV551SN30T1G*	3.0	LGE	TSOP-5 (Pb-Free)	3000 / Tape & Reel
NCV551SN31T1G*	3.1	LJR	TSOP-5 (Pb-Free)	3000 / Tape & Reel
NCV551SN32T1G*	3.2	LFR	TSOP-5 (Pb-Free)	3000 / Tape & Reel
NCV551SN33T1G*	3.3	LGG	TSOP-5 (Pb-Free)	3000 / Tape & Reel
NCV551SN36T1G*	3.6	AEJ	TSOP-5 (Pb-Free)	3000 / Tape & Reel
NCV551SN38T1G*	3.8	AD5	TSOP-5 (Pb-Free)	3000 / Tape & Reel
NCV551SN50T1G*	5.0	LGF	TSOP-5 (Pb-Free)	3000 / Tape & Reel

NOTE: Additional voltages in 100 mV steps are available upon request by contacting your ON Semiconductor representative.

†For information on tape and reel specifications, including part orientation and tape sizes, please refer to our Tape and Reel Packaging Specifications Brochure, BRD8011/D.

*NCV Prefix for Automotive and Other Applications Requiring Unique Site and Control Change Requirements; AEC-Q100 Qualified and PPAP Capable.

MECHANICAL CASE OUTLINE PACKAGE DIMENSIONS

ON Semiconductor®

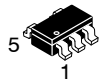

SCALE 2:1

TSOP-5 CASE 483 ISSUE N

DATE 12 AUG 2020

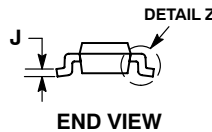
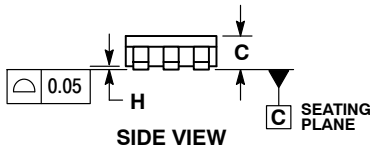
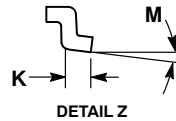
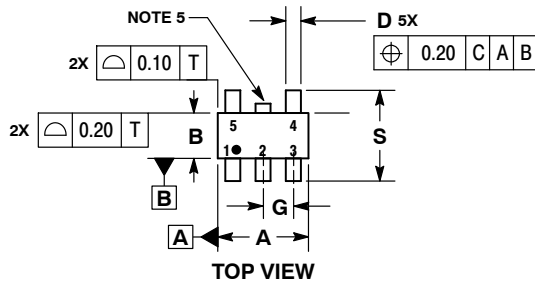

NOTES:

1. DIMENSIONING AND TOLERANCING PER ASME Y14.5M, 1994.
2. CONTROLLING DIMENSION: MILLIMETERS.
3. MAXIMUM LEAD THICKNESS INCLUDES LEAD FINISH THICKNESS. MINIMUM LEAD THICKNESS IS THE MINIMUM THICKNESS OF BASE MATERIAL.
4. DIMENSIONS A AND B DO NOT INCLUDE MOLD FLASH, PROTRUSIONS, OR GATE BURRS. MOLD FLASH, PROTRUSIONS, OR GATE BURRS SHALL NOT EXCEED 0.15 PER SIDE. DIMENSION A.
5. OPTIONAL CONSTRUCTION: AN ADDITIONAL TRIMMED LEAD IS ALLOWED IN THIS LOCATION. TRIMMED LEAD NOT TO EXTEND MORE THAN 0.2 FROM BODY.

DIM	MILLIMETERS	
	MIN	MAX
A	2.85	3.15
B	1.35	1.65
C	0.90	1.10
D	0.25	0.50
G	0.95 BSC	
H	0.01	0.10
J	0.10	0.26
K	0.20	0.60
M	0°	10°
S	2.50	3.00

SOLDERING FOOTPRINT*

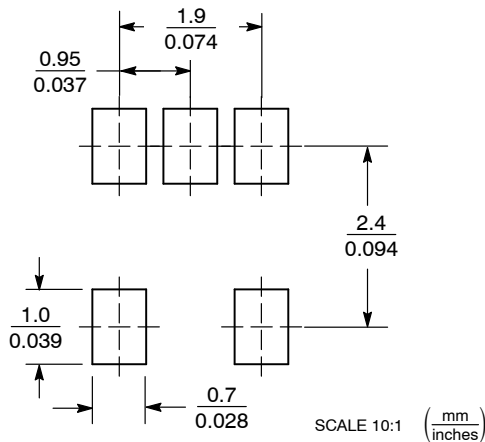

*For additional information on our Pb-Free strategy and soldering details, please download the ON Semiconductor Soldering and Mounting Techniques Reference Manual, SOLDERRM/D.

GENERIC MARKING DIAGRAM*

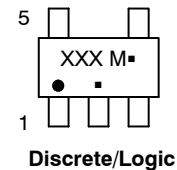
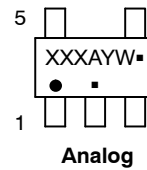

- XXX = Specific Device Code
 A = Assembly Location
 Y = Year
 W = Work Week
 ■ = Pb-Free Package
- XXX = Specific Device Code
 M = Date Code
 ■ = Pb-Free Package

(Note: Microdot may be in either location)

*This information is generic. Please refer to device data sheet for actual part marking. Pb-Free indicator, "G" or microdot "■", may or may not be present.

DOCUMENT NUMBER:	98ARB18753C	Electronic versions are uncontrolled except when accessed directly from the Document Repository. Printed versions are uncontrolled except when stamped "CONTROLLED COPY" in red.
DESCRIPTION:	TSOP-5	PAGE 1 OF 1

ON Semiconductor and ON are trademarks of Semiconductor Components Industries, LLC dba ON Semiconductor or its subsidiaries in the United States and/or other countries. ON Semiconductor reserves the right to make changes without further notice to any products herein. ON Semiconductor makes no warranty, representation or guarantee regarding the suitability of its products for any particular purpose, nor does ON Semiconductor assume any liability arising out of the application or use of any product or circuit, and specifically disclaims any and all liability, including without limitation special, consequential or incidental damages. ON Semiconductor does not convey any license under its patent rights nor the rights of others.

onsemi, **Onsemi**, and other names, marks, and brands are registered and/or common law trademarks of Semiconductor Components Industries, LLC dba "**onsemi**" or its affiliates and/or subsidiaries in the United States and/or other countries. **onsemi** owns the rights to a number of patents, trademarks, copyrights, trade secrets, and other intellectual property. A listing of **onsemi**'s product/patent coverage may be accessed at www.onsemi.com/site/pdf/Patent-Marking.pdf. **onsemi** reserves the right to make changes at any time to any products or information herein, without notice. The information herein is provided "as-is" and **onsemi** makes no warranty, representation or guarantee regarding the accuracy of the information, product features, availability, functionality, or suitability of its products for any particular purpose, nor does **onsemi** assume any liability arising out of the application or use of any product or circuit, and specifically disclaims any and all liability, including without limitation special, consequential or incidental damages. Buyer is responsible for its products and applications using **onsemi** products, including compliance with all laws, regulations and safety requirements or standards, regardless of any support or applications information provided by **onsemi**. "Typical" parameters which may be provided in **onsemi** data sheets and/or specifications can and do vary in different applications and actual performance may vary over time. All operating parameters, including "Typicals" must be validated for each customer application by customer's technical experts. **onsemi** does not convey any license under any of its intellectual property rights nor the rights of others. **onsemi** products are not designed, intended, or authorized for use as a critical component in life support systems or any FDA Class 3 medical devices or medical devices with a same or similar classification in a foreign jurisdiction or any devices intended for implantation in the human body. Should Buyer purchase or use **onsemi** products for any such unintended or unauthorized application, Buyer shall indemnify and hold **onsemi** and its officers, employees, subsidiaries, affiliates, and distributors harmless against all claims, costs, damages, and expenses, and reasonable attorney fees arising out of, directly or indirectly, any claim of personal injury or death associated with such unintended or unauthorized use, even if such claim alleges that **onsemi** was negligent regarding the design or manufacture of the part. **onsemi** is an Equal Opportunity/Affirmative Action Employer. This literature is subject to all applicable copyright laws and is not for resale in any manner.

ADDITIONAL INFORMATION

TECHNICAL PUBLICATIONS:

Technical Library: www.onsemi.com/design/resources/technical-documentation
onsemi Website: www.onsemi.com

ONLINE SUPPORT: www.onsemi.com/support

For additional information, please contact your local Sales Representative at www.onsemi.com/support/sales