

# BUL45D2G

## High Speed, High Gain Bipolar NPN Power Transistor

### with Integrated Collector–Emitter Diode and Built–in Efficient Antisaturation Network

The BUL45D2G is state-of-art High Speed High gain BiPolar transistor (H2BIP). High dynamic characteristics and lot-to-lot minimum spread ( $\pm 150$  ns on storage time) make it ideally suitable for light ballast applications. Therefore, there is no need to guarantee an  $h_{FE}$  window. It's characteristics make it also suitable for PFC application.

#### Features

- Low Base Drive Requirement
- High Peak DC Current Gain
- Extremely Low Storage Time Min/Max Guarantees Due to the H2BIP Structure which Minimizes the Spread
- Integrated Collector–Emitter Free Wheeling Diode
- Fully Characterized and Guaranteed Dynamic  $V_{CE(sat)}$
- “6 Sigma” Process Providing Tight and Reproducible Parameter Spreads
- These Devices are Pb–Free and are RoHS Compliant\*

#### MAXIMUM RATINGS

| Rating  | Symbol         | Value       | Unit                     |
|---|----------------|-------------|--------------------------|
| Collector–Emitter Sustaining Voltage  | $V_{CEO}$      | 400         | Vdc                      |
| Collector–Base Breakdown Voltage  | $V_{CBO}$      | 700         | Vdc                      |
| Collector–Emitter Breakdown Voltage   | $V_{CES}$      | 700         | Vdc                      |
| Emitter–Base Voltage  | $V_{EBO}$      | 12          | Vdc                      |
| Collector Current – Continuous  | $I_C$          | 5           | Adc                      |
| Collector Current – Peak (Note 1)   | $I_{CM}$       | 10          | Adc                      |
| Base Current – Continuous   | $I_B$          | 2           | Adc                      |
| Base Current – Peak (Note 1)  | $I_{BM}$       | 4           | Adc                      |
| Total Device Dissipation<br>@ $T_C = 25^\circ\text{C}$<br>Derate above $25^\circ\text{C}$ | $P_D$          | 75<br>0.6   | W<br>W/ $^\circ\text{C}$ |
| Operating and Storage Temperature   | $T_J, T_{stg}$ | -65 to +150 | $^\circ\text{C}$         |

Stresses exceeding those listed in the Maximum Ratings table may damage the device. If any of these limits are exceeded, device functionality should not be assumed, damage may occur and reliability may be affected.

1. Pulse Test: Pulse Width = 5 ms, Duty Cycle  $\leq 10\%$ .

\*For additional information on our Pb–Free strategy and soldering details, please download the ON Semiconductor Soldering and Mounting Techniques Reference Manual, SOLDERRM/D.



ON Semiconductor®

[www.onsemi.com](http://www.onsemi.com)

### POWER TRANSISTOR 5.0 AMPERES, 700 VOLTS, 75 WATTS

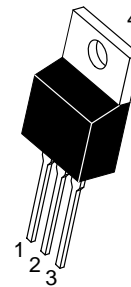
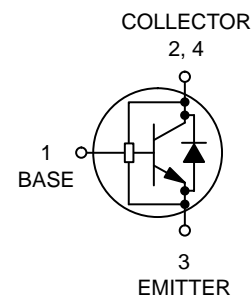

TO-220  
CASE 221A  
STYLE 1

#### MARKING DIAGRAM



- A = Assembly Location
- Y = Year
- WW = Work Week
- G = Pb–Free Package

#### ORDERING INFORMATION

| Device   | Package             | Shipping        |
|----------|---------------------|-----------------|
| BUL45D2G | TO-220<br>(Pb–Free) | 50 Units / Rail |

# BUL45D2G

## THERMAL CHARACTERISTICS

| Characteristics  | Symbol          | Max  | Unit          |
|--|-----------------|------|---------------|
| Thermal Resistance, Junction-to-Case   | $R_{\theta JC}$ | 1.65 | $^{\circ}C/W$ |
| Thermal Resistance, Junction-to-Ambient                                      | $R_{\theta JA}$ | 62.5 | $^{\circ}C/W$ |
| Maximum Lead Temperature for Soldering Purposes 1/8" from Case for 5 Seconds | $T_L$           | 260  | $^{\circ}C$   |

## ELECTRICAL CHARACTERISTICS ( $T_C = 25^{\circ}C$ unless otherwise noted)

| Characteristic | Symbol | Min | Typ | Max | Unit |
|----------------|--------|-----|-----|-----|------|
|----------------|--------|-----|-----|-----|------|

### OFF CHARACTERISTICS

|  |               |     |      |                   |                 |
|--|---------------|-----|------|-------------------|-----------------|
| Collector-Emitter Sustaining Voltage<br>( $I_C = 100$ mA, $L = 25$ mH)   | $V_{CE(sus)}$ | 400 | 450  | -                 | Vdc             |
| Collector-Base Breakdown Voltage<br>( $I_{CBO} = 1$ mA)  | $V_{CBO}$     | 700 | 910  | -                 | Vdc             |
| Emitter-Base Breakdown Voltage<br>( $I_{EBO} = 1$ mA)  | $V_{EBO}$     | 12  | 14.1 | -                 | Vdc             |
| Collector Cutoff Current<br>( $V_{CE} = \text{Rated } V_{CEO}$ , $I_B = 0$ )   | $I_{CEO}$     | -   | -    | 100               | $\mu\text{Adc}$ |
| Collector Cutoff Current<br>( $V_{CE} = \text{Rated } V_{CES}$ , $V_{EB} = 0$ )<br>@ $T_C = 25^{\circ}C$<br>@ $T_C = 125^{\circ}C$<br>( $V_{CE} = 500$ V, $V_{EB} = 0$ )<br>@ $T_C = 125^{\circ}C$ | $I_{CES}$     | -   | -    | 100<br>500<br>100 | $\mu\text{Adc}$ |
| Emitter-Cutoff Current<br>( $V_{EB} = 10$ Vdc, $I_C = 0$ )   | $I_{EBO}$     | -   | -    | 100               | $\mu\text{Adc}$ |

### ON CHARACTERISTICS

|  |               |                            |  |                                       |     |
|--|---------------|----------------------------|--|---------------------------------------|-----|
| Base-Emitter Saturation Voltage<br>( $I_C = 0.8$ Adc, $I_B = 80$ mAdc)<br>@ $T_C = 25^{\circ}C$<br>@ $T_C = 125^{\circ}C$<br>( $I_C = 2$ Adc, $I_B = 0.4$ Adc)<br>@ $T_C = 25^{\circ}C$<br>@ $T_C = 125^{\circ}C$  | $V_{BE(sat)}$ | -<br>-<br>-<br>-           | 0.8<br>0.7<br>0.89<br>0.79                   | 1<br>0.9<br>1<br>0.9                  | Vdc |
| Collector-Emitter Saturation Voltage<br>( $I_C = 0.8$ Adc, $I_B = 80$ mAdc)<br>@ $T_C = 25^{\circ}C$<br>@ $T_C = 125^{\circ}C$<br>( $I_C = 2$ Adc, $I_B = 0.4$ Adc)<br>@ $T_C = 25^{\circ}C$<br>@ $T_C = 125^{\circ}C$<br>( $I_C = 0.8$ Adc, $I_B = 40$ mAdc)<br>@ $T_C = 25^{\circ}C$<br>@ $T_C = 125^{\circ}C$ | $V_{CE(sat)}$ | -<br>-<br>-<br>-<br>-<br>- | 0.28<br>0.32<br>0.32<br>0.38<br>0.46<br>0.62 | 0.4<br>0.5<br>0.5<br>0.6<br>0.75<br>1 | Vdc |
| DC Current Gain<br>( $I_C = 0.8$ Adc, $V_{CE} = 1$ Vdc)<br>@ $T_C = 25^{\circ}C$<br>@ $T_C = 125^{\circ}C$<br>( $I_C = 2$ Adc, $V_{CE} = 1$ Vdc)<br>@ $T_C = 25^{\circ}C$<br>@ $T_C = 125^{\circ}C$  | $h_{FE}$      | 22<br>20<br>10<br>7        | 34<br>29<br>14<br>9.5                        | -<br>-<br>-<br>-                      | -   |

### DIODE CHARACTERISTICS

|   |          |                            |   |                                  |   |
|---|----------|----------------------------|---|----------------------------------|---|
| Forward Diode Voltage<br>( $I_{EC} = 1$ Adc)<br>@ $T_C = 25^{\circ}C$<br>@ $T_C = 125^{\circ}C$<br>( $I_{EC} = 2$ Adc)<br>@ $T_C = 25^{\circ}C$<br>@ $T_C = 125^{\circ}C$<br>( $I_{EC} = 0.4$ Adc)<br>@ $T_C = 25^{\circ}C$<br>@ $T_C = 125^{\circ}C$ | $V_{EC}$ | -<br>-<br>-<br>-<br>-<br>- | 1.04<br>0.7<br>1.2<br>-<br>0.85<br>0.62 | 1.5<br>-<br>1.6<br>-<br>1.2<br>- | V |
|---|----------|----------------------------|---|----------------------------------|---|

# BUL45D2G

## ELECTRICAL CHARACTERISTICS (continued) ( $T_C = 25^\circ\text{C}$ unless otherwise noted)

| Characteristic | Symbol | Min | Typ | Max | Unit |
|----------------|--------|-----|-----|-----|------|
|----------------|--------|-----|-----|-----|------|

### DIODE CHARACTERISTICS

|   |          |   |                   |   |    |
|---|----------|---|-------------------|---|----|
| Forward Recovery Time (see Figure 27)<br>( $I_F = 1 \text{ Adc}$ , $di/dt = 10 \text{ A}/\mu\text{s}$ )<br>@ $T_C = 25^\circ\text{C}$<br>( $I_F = 2 \text{ Adc}$ , $di/dt = 10 \text{ A}/\mu\text{s}$ )<br>@ $T_C = 25^\circ\text{C}$<br>( $I_F = 0.4 \text{ Adc}$ , $di/dt = 10 \text{ A}/\mu\text{s}$ )<br>@ $T_C = 25^\circ\text{C}$ | $T_{fr}$ | - | 330<br>360<br>320 | - | ns |
|---|----------|---|-------------------|---|----|

### DYNAMIC CHARACTERISTICS

|   |          |   |     |     |     |
|---|----------|---|-----|-----|-----|
| Current Gain Bandwidth<br>( $I_C = 0.5 \text{ Adc}$ , $V_{CE} = 10 \text{ Vdc}$ , $f = 1 \text{ MHz}$ ) | $f_T$    | - | 13  | -   | MHz |
| Output Capacitance<br>( $V_{CB} = 10 \text{ Vdc}$ , $I_E = 0$ , $f = 1 \text{ MHz}$ )                   | $C_{ob}$ | - | 50  | 75  | pF  |
| Input Capacitance<br>( $V_{EB} = 8 \text{ Vdc}$ )   | $C_{ib}$ | - | 340 | 500 | pF  |

### DYNAMIC SATURATION VOLTAGE

|  |  |                   |   |                |            |             |   |   |
|--|--|-------------------|---|----------------|------------|-------------|---|---|
| Dynamic Saturation Voltage:<br>Determined 1 $\mu\text{s}$ and 3 $\mu\text{s}$ respectively after rising $I_{B1}$ reaches 90% of final $I_{B1}$ | $I_C = 1 \text{ A}$<br>$I_{B1} = 100 \text{ mA}$<br>$V_{CC} = 300 \text{ V}$ | @ 1 $\mu\text{s}$ | @ $T_C = 25^\circ\text{C}$<br>@ $T_C = 125^\circ\text{C}$ | $V_{CE(dsat)}$ | -          | 3.7<br>9.4  | - | V |
|  |  | @ 3 $\mu\text{s}$ | @ $T_C = 25^\circ\text{C}$<br>@ $T_C = 125^\circ\text{C}$ |                | -          | 0.35<br>2.7 | - | V |
|  | $I_C = 2 \text{ A}$<br>$I_{B1} = 0.8 \text{ A}$<br>$V_{CC} = 300 \text{ V}$  | @ 1 $\mu\text{s}$ | @ $T_C = 25^\circ\text{C}$<br>@ $T_C = 125^\circ\text{C}$ | -              | 3.9<br>12  | -           | V |   |
|  |  | @ 3 $\mu\text{s}$ | @ $T_C = 25^\circ\text{C}$<br>@ $T_C = 125^\circ\text{C}$ | -              | 0.4<br>1.5 | -           | V |   |

### SWITCHING CHARACTERISTICS: Resistive Load ( $D.C. \leq 10\%$ , Pulse Width = 20 $\mu\text{s}$ )

|               |  |   |           |     |             |     |               |
|---------------|--|---|-----------|-----|-------------|-----|---------------|
| Turn-on Time  | $I_C = 2 \text{ Adc}$ , $I_{B1} = 0.4 \text{ Adc}$<br>$I_{B2} = 1 \text{ Adc}$<br>$V_{CC} = 300 \text{ Vdc}$   | @ $T_C = 25^\circ\text{C}$<br>@ $T_C = 125^\circ\text{C}$ | $t_{on}$  | -   | 90<br>105   | 150 | ns            |
| Turn-off Time |  | @ $T_C = 25^\circ\text{C}$<br>@ $T_C = 125^\circ\text{C}$ | $t_{off}$ | -   | 1.15<br>1.5 | 1.3 | $\mu\text{s}$ |
| Turn-on Time  | $I_C = 2 \text{ Adc}$ , $I_{B1} = 0.4 \text{ Adc}$<br>$I_{B2} = 0.4 \text{ Adc}$<br>$V_{CC} = 300 \text{ Vdc}$ | @ $T_C = 25^\circ\text{C}$<br>@ $T_C = 125^\circ\text{C}$ | $t_{on}$  | -   | 90<br>110   | 150 | ns            |
| Turn-off Time |  | @ $T_C = 25^\circ\text{C}$<br>@ $T_C = 125^\circ\text{C}$ | $t_{off}$ | 2.1 | -<br>3.1    | 2.4 | $\mu\text{s}$ |

### SWITCHING CHARACTERISTICS: Inductive Load ( $V_{clamp} = 300 \text{ V}$ , $V_{CC} = 15 \text{ V}$ , $L = 200 \mu\text{H}$ )

|                |   |   |       |      |              |      |               |
|----------------|---|---|-------|------|--------------|------|---------------|
| Fall Time      | $I_C = 1 \text{ Adc}$<br>$I_{B1} = 100 \text{ mAdc}$<br>$I_{B2} = 500 \text{ mAdc}$ | @ $T_C = 25^\circ\text{C}$<br>@ $T_C = 125^\circ\text{C}$ | $t_f$ | -    | 90<br>93     | 150  | ns            |
| Storage Time   |   | @ $T_C = 25^\circ\text{C}$<br>@ $T_C = 125^\circ\text{C}$ | $t_s$ | -    | 0.72<br>1.05 | 0.9  | $\mu\text{s}$ |
| Crossover Time |   | @ $T_C = 25^\circ\text{C}$<br>@ $T_C = 125^\circ\text{C}$ | $t_c$ | -    | 95<br>95     | 150  | ns            |
| Fall Time      | $I_C = 2 \text{ Adc}$<br>$I_{B1} = 0.4 \text{ Adc}$<br>$I_{B2} = 0.4 \text{ Adc}$   | @ $T_C = 25^\circ\text{C}$<br>@ $T_C = 125^\circ\text{C}$ | $t_f$ | -    | 80<br>105    | 150  | ns            |
| Storage Time   |   | @ $T_C = 25^\circ\text{C}$<br>@ $T_C = 125^\circ\text{C}$ | $t_s$ | 1.95 | -<br>2.9     | 2.25 | $\mu\text{s}$ |
| Crossover Time |   | @ $T_C = 25^\circ\text{C}$<br>@ $T_C = 125^\circ\text{C}$ | $t_c$ | -    | 225<br>450   | 300  | ns            |

Product parametric performance is indicated in the Electrical Characteristics for the listed test conditions, unless otherwise noted. Product performance may not be indicated by the Electrical Characteristics if operated under different conditions.

# BUL45D2G

## TYPICAL STATIC CHARACTERISTICS

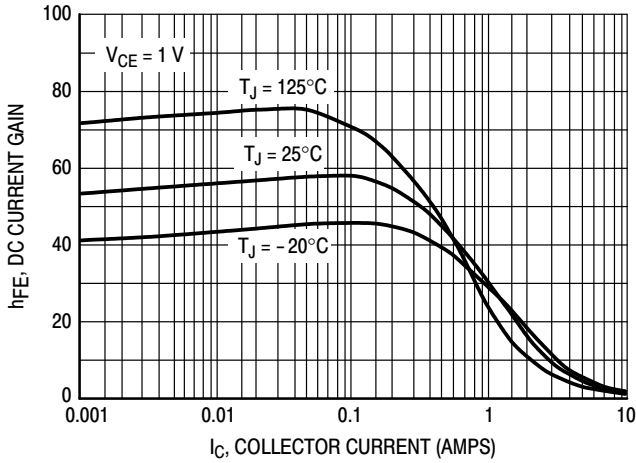

Figure 1. DC Current Gain @ 1 Volt

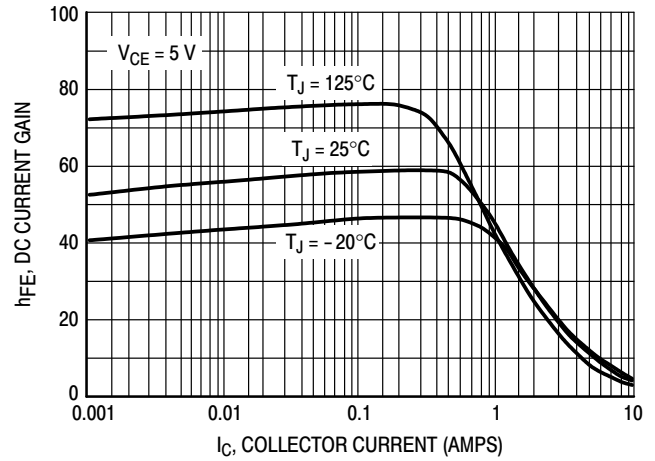

Figure 2. DC Current Gain @ 5 Volt

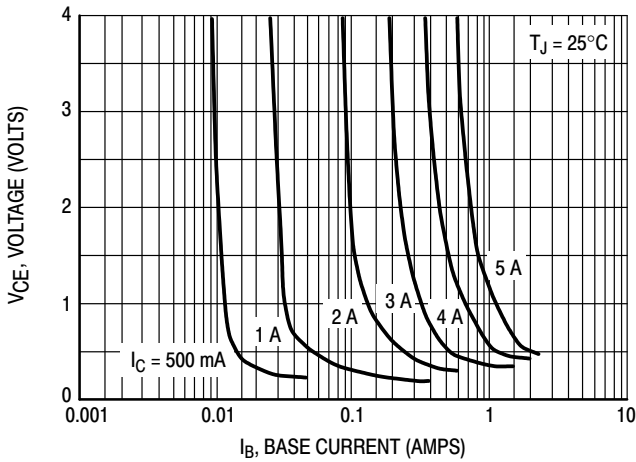

Figure 3. Collector Saturation Region

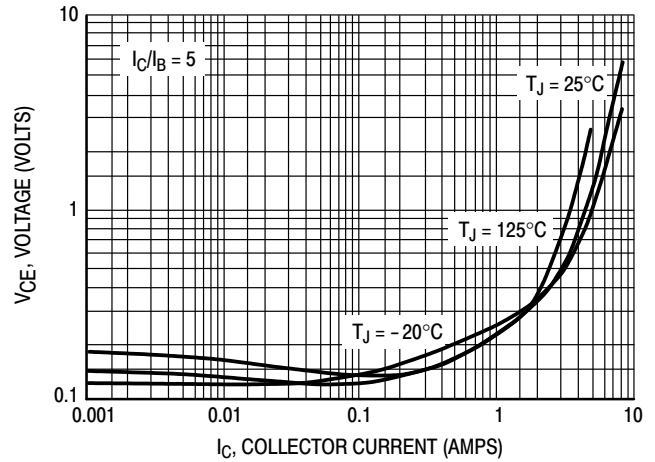

Figure 4. Collector-Emitter Saturation Voltage

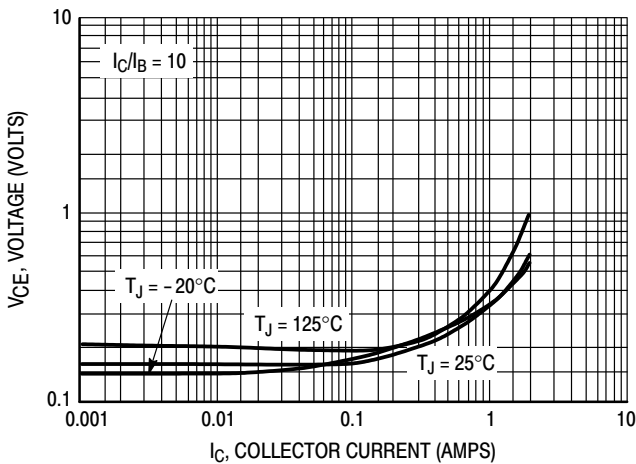

Figure 5. Collector-Emitter Saturation Voltage

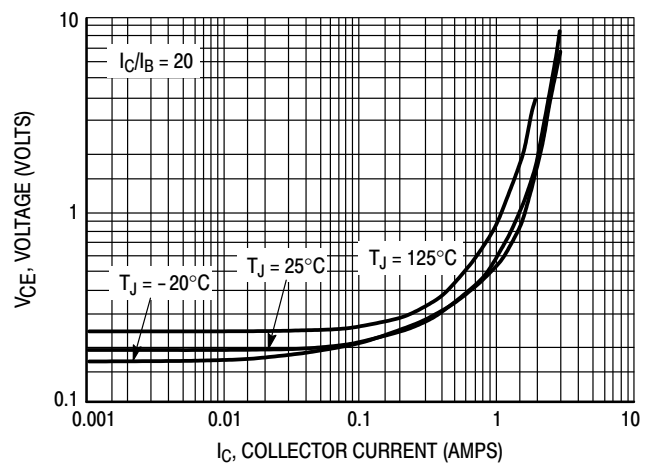

Figure 6. Collector-Emitter Saturation Voltage

# BUL45D2G

## TYPICAL STATIC CHARACTERISTICS

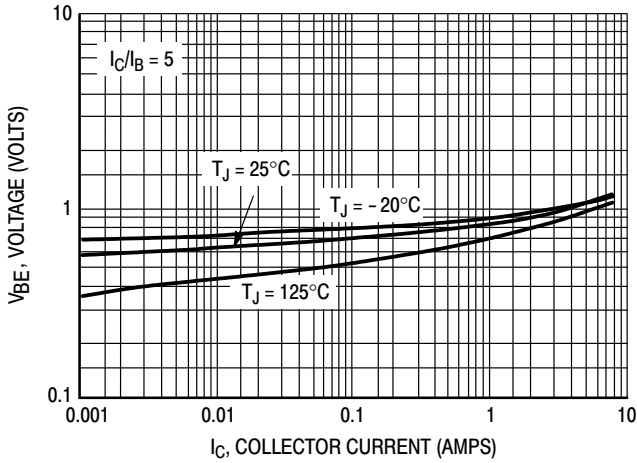

Figure 7. Base-Emitter Saturation Region

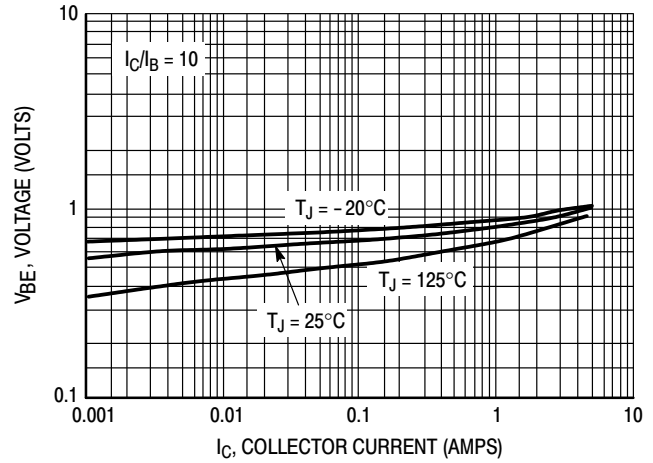

Figure 8. Base-Emitter Saturation Region

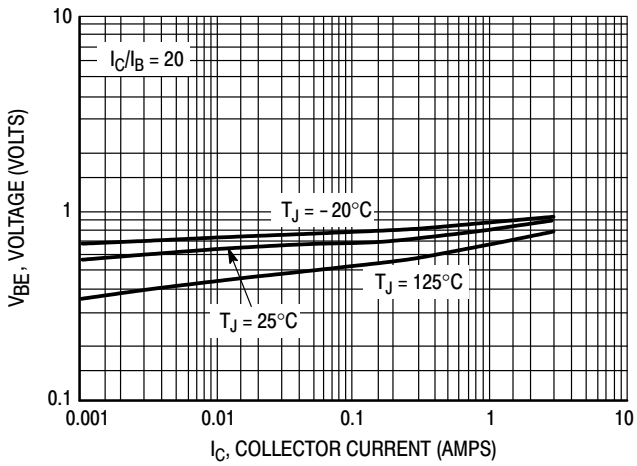

Figure 9. Base-Emitter Saturation Region

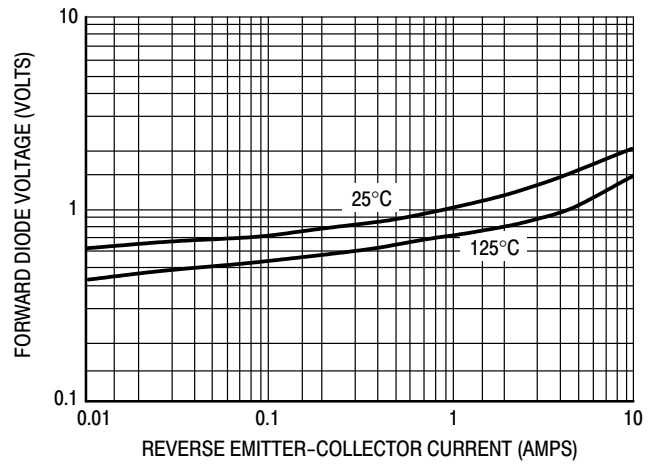

Figure 10. Forward Diode Voltage

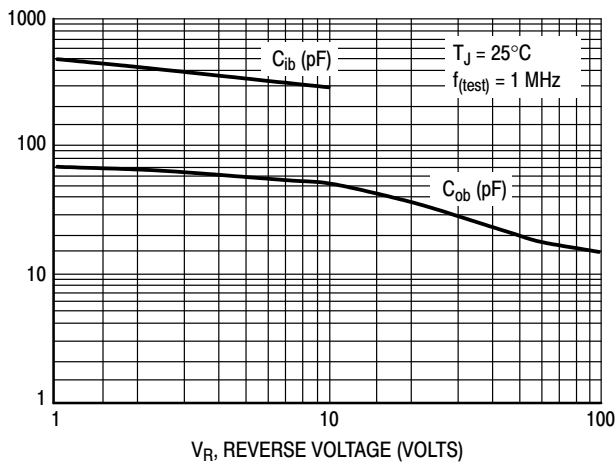

Figure 11. Capacitance

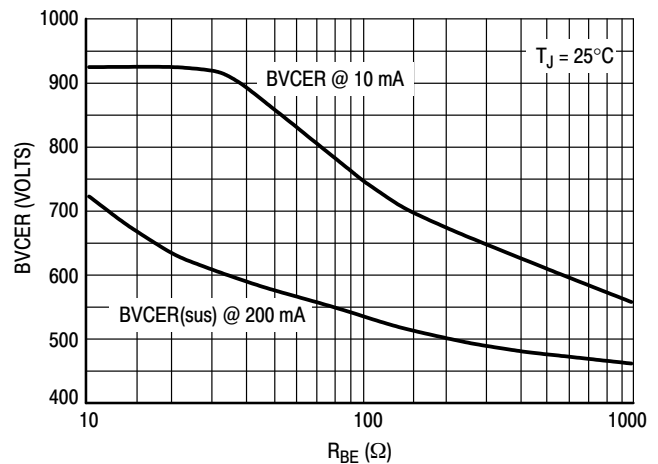

Figure 12. BVCEr = f(ICER)

TYPICAL SWITCHING CHARACTERISTICS

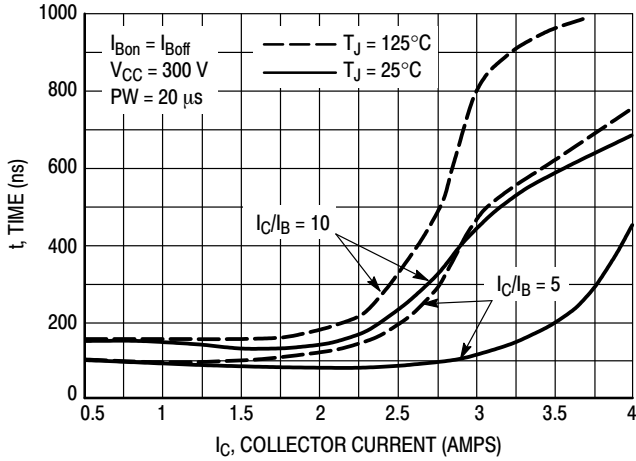

Figure 13. Resistive Switch Time,  $t_{on}$

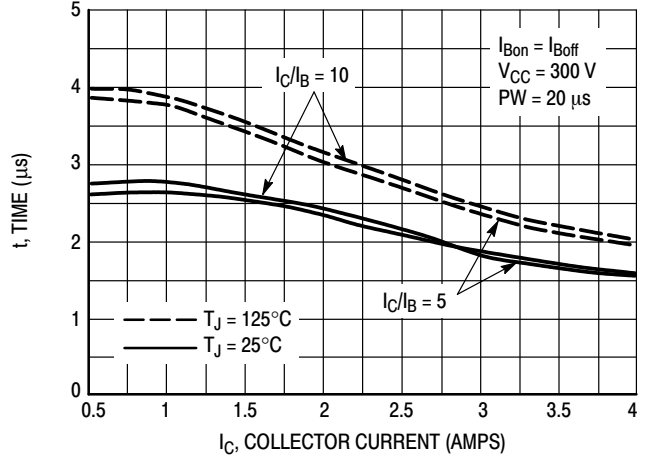

Figure 14. Resistive Switch Time,  $t_{off}$

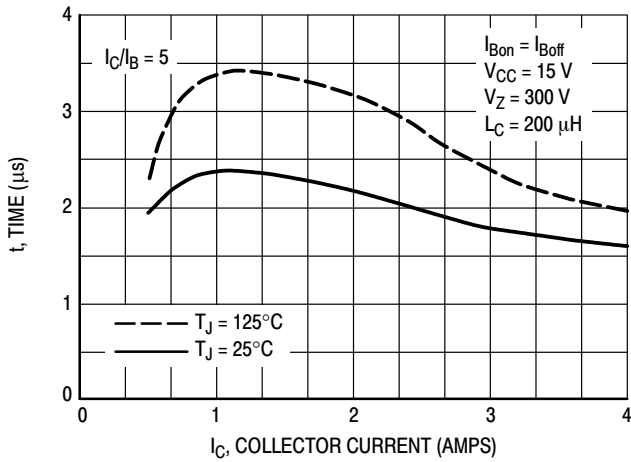

Figure 15. Inductive Storage Time,  $t_{si}$  @  $I_C/I_B = 5$

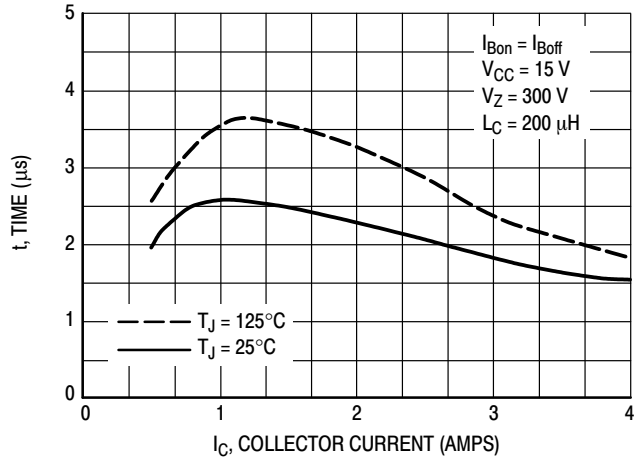

Figure 16. Inductive Storage Time,  $t_{si}$  @  $I_C/I_B = 10$

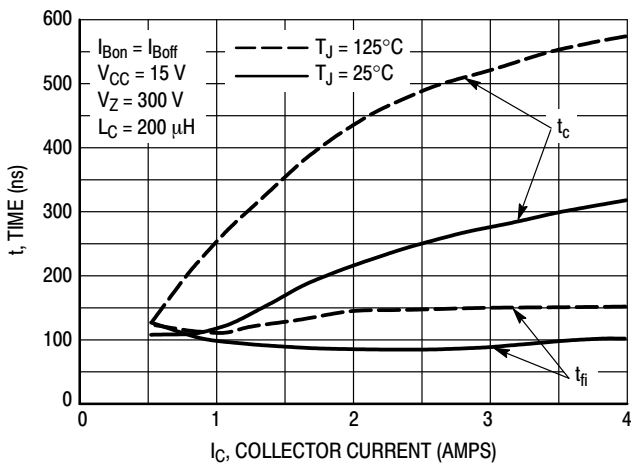

Figure 17. Inductive Switching,  $t_c$  &  $t_{fi}$  @  $I_C/I_B = 5$

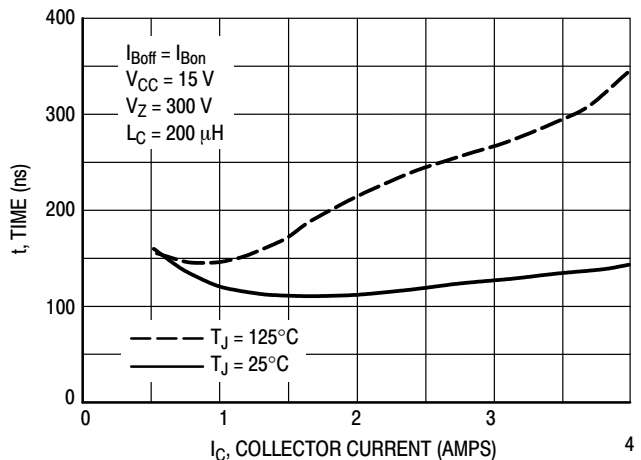

Figure 18. Inductive Switching,  $t_{fi}$  @  $I_C/I_B = 10$

TYPICAL SWITCHING CHARACTERISTICS

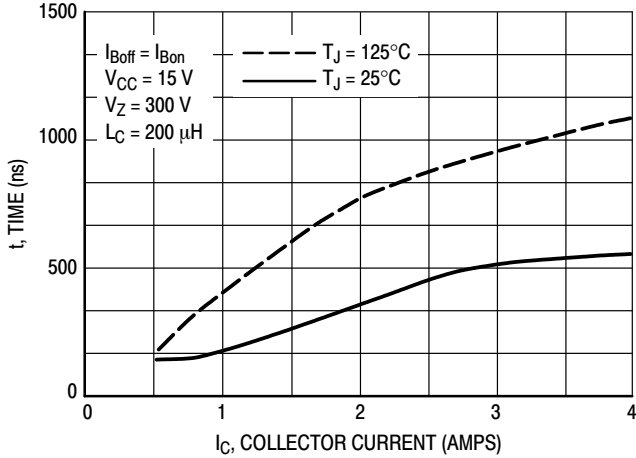

Figure 19. Inductive Switching,  $t_c$  @  $I_C/I_B = 10$

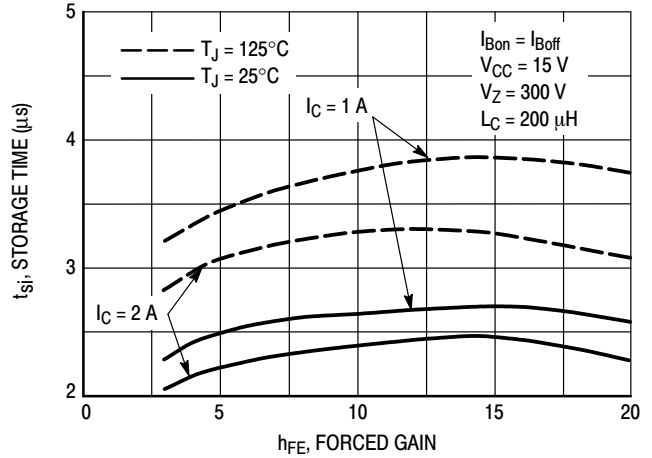

Figure 20. Inductive Storage Time

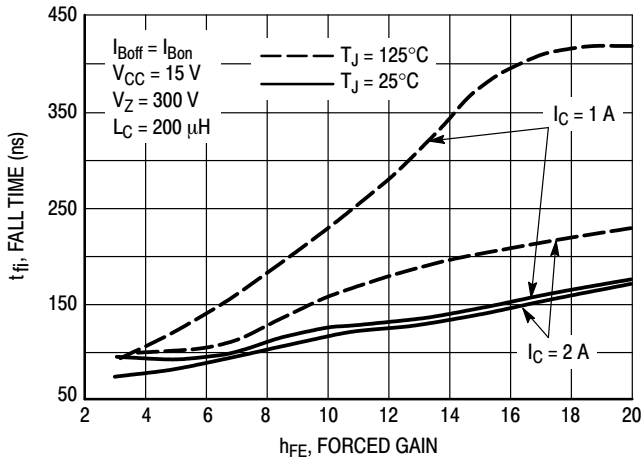

Figure 21. Inductive Fall Time

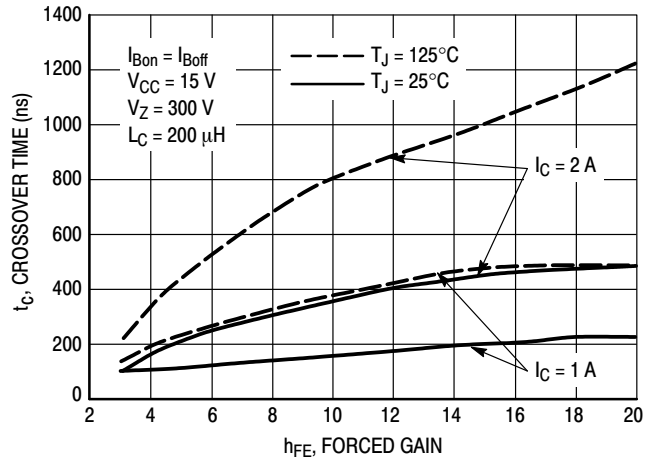

Figure 22. Inductive Crossover Time

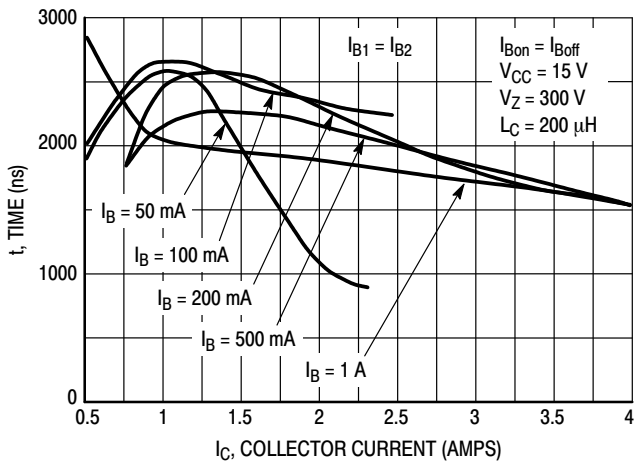

Figure 23. Inductive Storage Time,  $t_{si}$

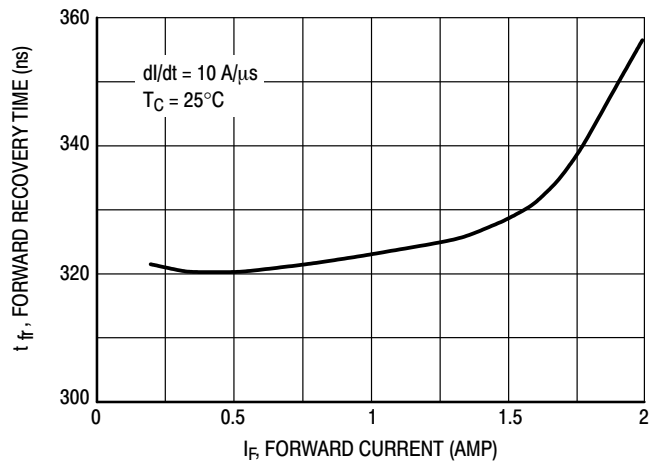

Figure 24. Forward Recovery Time  $t_{fr}$

# BUL45D2G

## TYPICAL SWITCHING CHARACTERISTICS

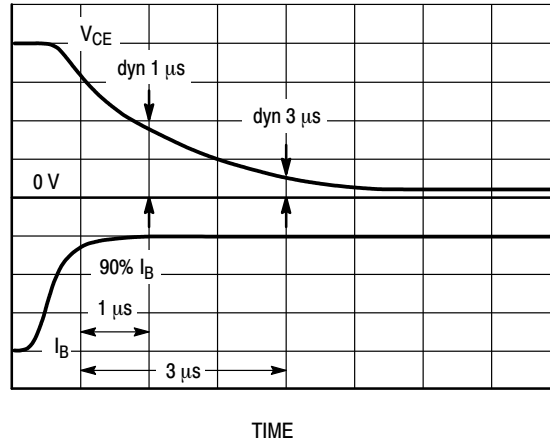

Figure 25. Dynamic Saturation Voltage Measurements

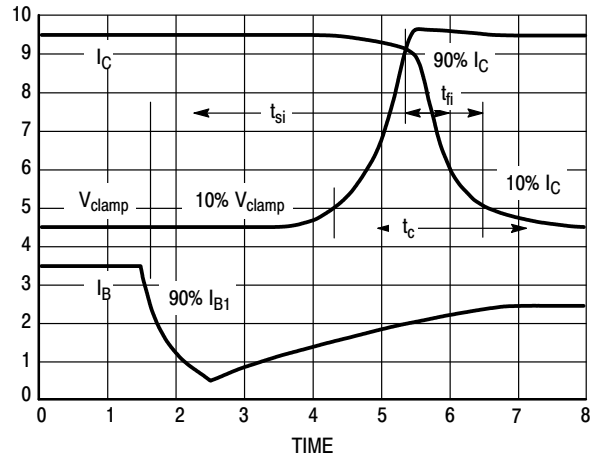

Figure 26. Inductive Switching Measurements

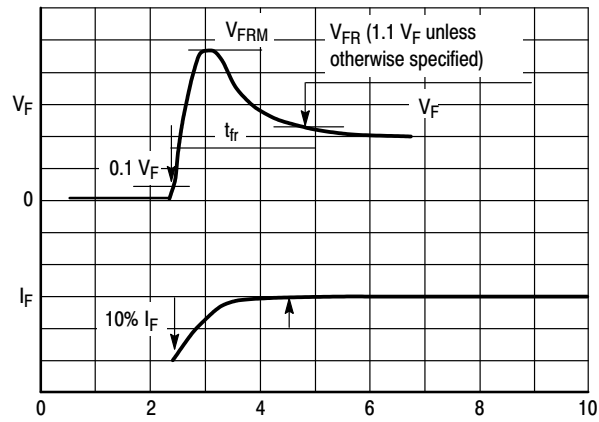

Figure 27.  $t_{\text{fr}}$  Measurements



# BUL45D2G

## TYPICAL SWITCHING CHARACTERISTICS

Table 1. Inductive Load Switching Drive Circuit

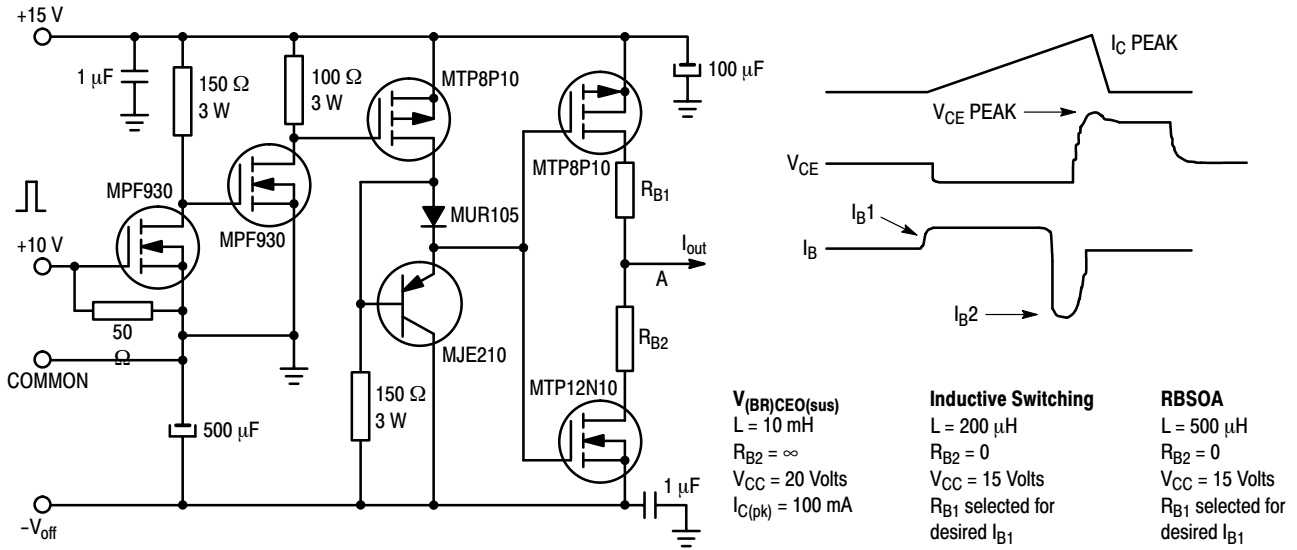

## TYPICAL CHARACTERISTICS

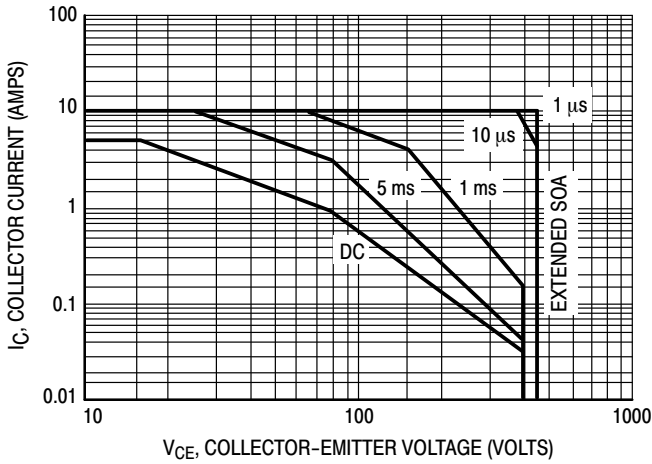

Figure 28. Forward Bias Safe Operating Area

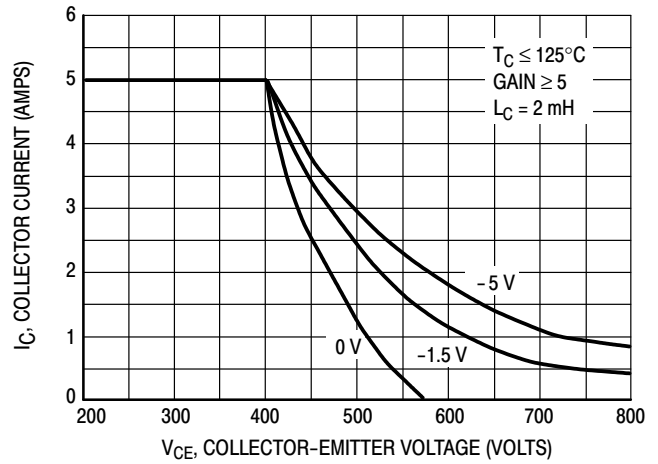

Figure 29. Reverse Bias Safe Operating Area

# BUL45D2G

## TYPICAL CHARACTERISTICS

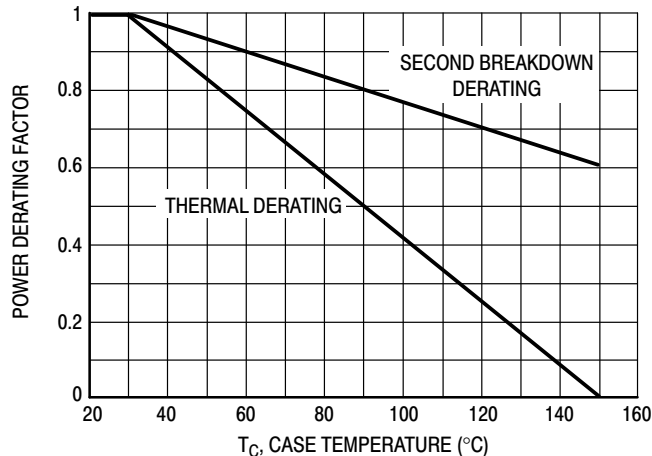

Figure 30. Forward Bias Power Derating

There are two limitations on the power handling ability of a transistor: average junction temperature and second breakdown. Safe operating area curves indicate  $I_C-V_{CE}$  limits of the transistor that must be observed for reliable operation; i.e., the transistor must not be subjected to greater dissipation than the curves indicate. The data of Figure 28 is based on  $T_C = 25^\circ\text{C}$ ;  $T_{J(pk)}$  is variable depending on power level. Second breakdown pulse limits are valid for duty cycles to 10% but must be derated when  $T_C > 25^\circ\text{C}$ . Second breakdown limitations do not derate the same as thermal limitations. Allowable current at the voltages shown on

Figure 28 may be found at any case temperature by using the appropriate curve on Figure 30.

$T_{J(pk)}$  may be calculated from the data in Figure 31. At any case temperatures, thermal limitations will reduce the power that can be handled to values less than the limitations imposed by second breakdown. For inductive loads, high voltage and current must be sustained simultaneously during turn-off with the base to emitter junction reverse biased. The safe level is specified as a reverse biased safe operating area (Figure 29). This rating is verified under clamped conditions so that the device is never subjected to an avalanche mode.

## TYPICAL THERMAL RESPONSE

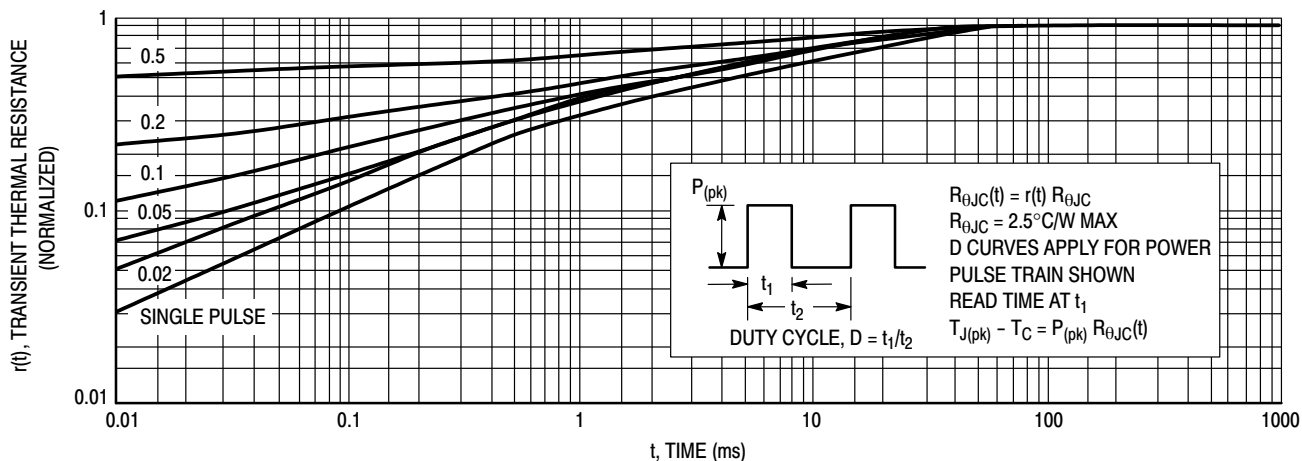

Figure 31. Typical Thermal Response ( $Z_{0JC}(t)$ ) for BUL45D2

**onsemi**, **Onsemi**, and other names, marks, and brands are registered and/or common law trademarks of Semiconductor Components Industries, LLC dba "**onsemi**" or its affiliates and/or subsidiaries in the United States and/or other countries. **onsemi** owns the rights to a number of patents, trademarks, copyrights, trade secrets, and other intellectual property. A listing of **onsemi**'s product/patent coverage may be accessed at [www.onsemi.com/site/pdf/Patent-Marking.pdf](http://www.onsemi.com/site/pdf/Patent-Marking.pdf). **onsemi** reserves the right to make changes at any time to any products or information herein, without notice. The information herein is provided "as-is" and **onsemi** makes no warranty, representation or guarantee regarding the accuracy of the information, product features, availability, functionality, or suitability of its products for any particular purpose, nor does **onsemi** assume any liability arising out of the application or use of any product or circuit, and specifically disclaims any and all liability, including without limitation special, consequential or incidental damages. Buyer is responsible for its products and applications using **onsemi** products, including compliance with all laws, regulations and safety requirements or standards, regardless of any support or applications information provided by **onsemi**. "Typical" parameters which may be provided in **onsemi** data sheets and/or specifications can and do vary in different applications and actual performance may vary over time. All operating parameters, including "Typicals" must be validated for each customer application by customer's technical experts. **onsemi** does not convey any license under any of its intellectual property rights nor the rights of others. **onsemi** products are not designed, intended, or authorized for use as a critical component in life support systems or any FDA Class 3 medical devices or medical devices with a same or similar classification in a foreign jurisdiction or any devices intended for implantation in the human body. Should Buyer purchase or use **onsemi** products for any such unintended or unauthorized application, Buyer shall indemnify and hold **onsemi** and its officers, employees, subsidiaries, affiliates, and distributors harmless against all claims, costs, damages, and expenses, and reasonable attorney fees arising out of, directly or indirectly, any claim of personal injury or death associated with such unintended or unauthorized use, even if such claim alleges that **onsemi** was negligent regarding the design or manufacture of the part. **onsemi** is an Equal Opportunity/Affirmative Action Employer. This literature is subject to all applicable copyright laws and is not for resale in any manner.

## ADDITIONAL INFORMATION

### TECHNICAL PUBLICATIONS:

Technical Library: [www.onsemi.com/design/resources/technical-documentation](http://www.onsemi.com/design/resources/technical-documentation)  
onsemi Website: [www.onsemi.com](http://www.onsemi.com)

### ONLINE SUPPORT: [www.onsemi.com/support](http://www.onsemi.com/support)

For additional information, please contact your local Sales Representative at [www.onsemi.com/support/sales](http://www.onsemi.com/support/sales)