

## ISL8105BEVAL1Z, ISL8105BEVAL2Z

### Evaluation Boards

AN1288  
Rev 1.00  
October 30, 2008

### Introduction

The ISL8105B is a simple single-phase PWM controller for a synchronous buck converter that operates from +5V or +12V bias supply voltage. With integrated linear regulator, boot diode, and gate drivers, the ISL8105B reduces external component count and board space requirements.

The ISL8105BEVAL1Z, ISL8105BEVAL2Z evaluation board highlights the operations of the controller in a DC/DC application.

### ISL8105BEVAL1Z, ISL8105BEVAL2Z Reference Design

The ISL8105BEVAL1Z, ISL8105BEVAL2Z evaluation board is designed to optimize for the output voltage and current specifications shown in Table 1.

**TABLE 1. ISL8105BEVAL1Z, ISL8105BEVAL2Z EVALUATION BOARD DESIGN PARAMETERS**

PARAMETER	MIN	TYP	MAX
Input Voltage (V <sub>IN</sub> )	9.6V	12V	14.4V
Output Voltage (V <sub>OUT</sub> )		1.8V	
Output Voltage Ripple (V <sub>RIPPLE</sub> )		30mV <sub>p-p</sub>	
Continuous Load Current			15A
Efficiency		90	

Two versions of the evaluation board, based on the package type, are listed in Table 2.

**TABLE 2. EVALUATION BOARDS**

BOARD NAME	IC	PACKAGE
ISL8105BEVAL1Z	ISL8105BIBZ	8 Ld SOIC
ISL8105BEVAL2Z	ISL8105BIRZ	10 Ld DFN

### Design Procedure

The following sections illustrate simple design steps and component selections for a converter using the ISL8105BEVAL1Z, ISL8105BEVAL2Z.

#### Output Inductor Selection

The output inductor is chosen by the desired inductor ripple current, which is typically set to be approximately 40% of the rated output current. The desired output inductor can be calculated using Equation 1:

$$L = \frac{V_{IN} - V_{OUT}}{\Delta I} \times \frac{V_{OUT}}{V_{IN}} \times \frac{1}{F_{SW}}$$

$$= \frac{14.4 - 1.8}{0.4 \cdot 15} \times \frac{1.8}{14.4} \times \frac{1}{300 \times 10^3}$$

$$= 0.875 \mu\text{H} \quad (\text{EQ. 1})$$

In the evaluation board, a 1μH inductor with 1.87mΩ DCR (Cooper Bussmann's HC9-1R0-R) is employed. This yields approximately 0.44W conduction loss in the inductor.

#### Output Capacitor Selection

The output capacitors are generally selected by the output voltage ripple and load transient response requirements. ESR and capacitor charge are major contributions to the output voltage ripple. Assuming that the total output capacitance is sufficient, then the output voltage ripple is dominated by the ESR, which can be calculated using Equation 2.

$$V_{RIPPLE} = \Delta I_L \cdot \text{ESR} \quad (\text{EQ. 2})$$

To meet the 30mV<sub>p-p</sub> output voltage ripple requirement, the effective ESR should be less than 5mΩ.

The output voltage response to a transient load is contributed from ESL, ESR and the amount of output capacitance. With V<sub>IN</sub> >> V<sub>OUT</sub>, the amplitude of the voltage excursions can be approximated using Equation 3:

$$\Delta V = \frac{L \cdot I_{\text{tran}}^2}{C_{\text{OUT}} \cdot V_{\text{OUT}}} \quad (\text{EQ. 3})$$

With 1μH inductor and 0A to 15A step load, the total output capacitance of 1560μF is required for 80mV output voltage transient. In the ISL8105BEVAL1Z, ISL8105BEVAL2Z evaluation board, four of Sanyo's 2R5TPF470ML are employed.

#### Input Capacitor Selection

The input bulk capacitors selection criteria are based on the capacitance and RMS current capability. The RMS current rating requirement for the input capacitor is approximated in Equation 4:

$$I_{IN, RMS} = \sqrt{I_O^2(D - D^2) + \frac{\Delta I^2}{12}D} \quad D = \frac{V_O}{V_{IN}} \quad (\text{EQ. 4})$$

In this application, the RMS current for the input capacitors is 5.4A; therefore, three of Sanyo's 35ME330AX are used.

Small ceramic capacitors for high frequency decoupling are also required to control the voltage overshoot across the MOSFETs.

#### MOSFET Selection

The ISL8105B requires two N-Channel power MOSFETs as the main and the synchronous switches. These should be selected based on r<sub>DS(ON)</sub>, gate supply requirements and thermal management requirements.

The total power loss in MOSFET consists of conduction loss and switching loss, as shown in Equation 5:

$$P_{\text{MOSFET(TOT)}} = P_{\text{cond}} + P_{\text{sw}} \quad (\text{EQ. 5})$$

In this relatively small duty cycle design, the low-side MOSFET conducts current most of the time. To optimize the converter efficiency, select the high-side MOSFET with low gate charge for fast switching transition and low-side MOSFET with low  $r_{\text{DS(ON)}}$ .

To achieve the target efficiency, the budget power losses in high-side and low-side MOSFETs are 0.5W and 1W, respectively.

### LOW-SIDE MOSFET SELECTION

The low-side MOSFET's RMS current is approximated in Equation 6:

$$I_{\text{L(RMS)}} = I_{\text{OUT}} \cdot \sqrt{1-D} \cdot \sqrt{1 + \frac{1}{12} \cdot \left(\frac{\Delta I_{\text{L}}}{I_{\text{OUT}}}\right)^2} \approx 13.9\text{A} \quad (\text{EQ. 6})$$

Therefore, the ON-resistance of the low-side MOSFET must be less than  $5\text{m}\Omega$ . Infineon's BSC030N03LS is employed in the ISL8105BEVAL1Z, ISL8105BEVAL2Z evaluation board. The conduction loss in the low-side MOSFET is calculated using Equation 7:

$$P_{\text{LFET(cond)}} = I_{\text{L(RMS)}}^2 \cdot r_{\text{DS(ON)}}|_{\text{LFET}} = 0.58\text{W} \quad (\text{EQ. 7})$$

The switching loss in the low-side MOSFET is dominated by the loss in body diode which can be calculated using Equation 8:

$$P_{\text{diode}} = I_{\text{O}} \cdot t_{\text{D}} \cdot V_{\text{F}} \cdot F_{\text{SW}} = 0.3\text{W} \quad (\text{EQ. 8})$$

Where  $t_{\text{D}}$  is the total dead time in each switching period ( $\sim 60\mu\text{s}$ ) and  $V_{\text{F}}$  is the forward voltage drop of MOSFET's body diode.

The total power dissipation in the low-side MOSFET is calculated using Equation 9:

$$P_{\text{LFET(TOT)}} = 0.88\text{W} \quad (\text{EQ. 9})$$

### HIGH-SIDE MOSFET SELECTION

For the high-side MOSFET selection, first we assume that the conduction loss and the switching loss contribute evenly to the total power dissipation.

The high-side MOSFET's RMS current is approximated using Equation 10:

$$I_{\text{H(rms)}} = I_{\text{OUT}} \cdot \sqrt{D} \cdot \sqrt{1 + \frac{1}{12} \cdot \left(\frac{\Delta I_{\text{L}}}{I_{\text{OUT}}}\right)^2} \approx 5.85\text{A} \quad (\text{EQ. 10})$$

Hence, the required ON-resistance of the high-side MOSFET is  $7.3\text{m}\Omega$ . Infineon's BSC080N03LS is selected. The conduction loss in the high-side MOSFET is calculated using Equation 11:

$$P_{\text{HFET(cond)}} = I_{\text{H(RMS)}}^2 \cdot r_{\text{DS(ON)}}|_{\text{HFET}} = 0.27\text{W} \quad (\text{EQ. 11})$$

The switching loss in the high-side MOSFET can be approximated using Equation 12:

$$P_{\text{HFET(SW)}} = \frac{1}{2} \cdot I_{\text{O}} \cdot V_{\text{IN}} \cdot t_{\text{tr}} \cdot F_{\text{SW}} + \frac{1}{2} \cdot C_{\text{OSS}} \cdot V_{\text{IN}}^2 \cdot F_{\text{SW}} = 0.17\text{W} \quad (\text{EQ. 12})$$

where  $t_{\text{tr}}$  is the combined ON and OFF MOSFET transition times.

The total power dissipation in high-side MOSFET is shown in Equation 13:

$$P_{\text{HFET(TOT)}} = 0.44\text{W} \quad (\text{EQ. 13})$$

### Overcurrent Protection Setting

The overcurrent function protects the converter from a shorted output by using the low-side MOSFET's  $r_{\text{DS(ON)}}$  to monitor the current. A resistor,  $R_{\text{BSOC}}$ , programs the overcurrent trip level. If overcurrent is detected, the output immediately shuts off, it cycles the soft-start function in a hiccup mode (2 dummy soft-start time-outs, then up to one real one) to provide fault protection. If the shorted condition is not removed, this cycle will continue indefinitely.

The overcurrent function will trip at a inductor current ( $I_{\text{trip}}$ ) is determined using Equation 14:

$$I_{\text{trip}} = \frac{2 \cdot I_{\text{OCSET}} \cdot R_{\text{BSOC}}}{r_{\text{DS(ON)}}} \quad (\text{EQ. 14})$$

where  $I_{\text{OCSET}}$  is the internal  $21.5\mu\text{A}$  (typ.) OCSET current source.

The OC trip point varies mainly due to the MOSFET's  $r_{\text{DS(ON)}}$  variations. To avoid overcurrent tripping in the normal operating load range, calculate the  $R_{\text{BSOC}}$  resistor from Equation 14 using:

1. The maximum  $r_{\text{DS(ON)}}$  at the highest junction temperature.
2. The minimum  $I_{\text{OCSET}}$  from the specification table of the datasheet.

Determine  $I_{\text{trip}}$  for  $I_{\text{trip}} > I_{\text{OUT(MAX)}} + (\Delta I)/2$ , where  $\Delta I$  is the output inductor ripple current.

With Infineon's BSC030N03LS as the low-side MOSFET and  $R_{BSOC}$  of 1.74k $\Omega$ . The overcurrent trip point on the evaluation board has been set to 21A for 12V<sub>BIAS</sub> (17A for 5V<sub>BIAS</sub>).

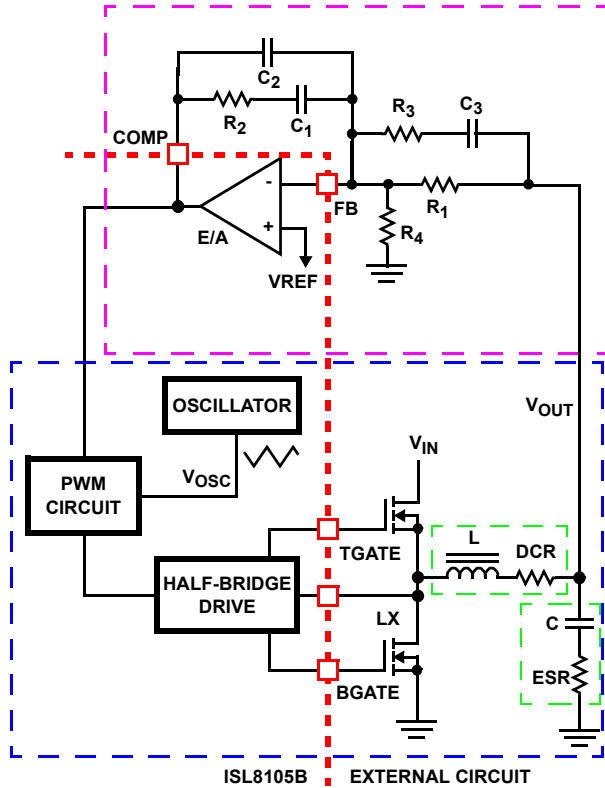

FIGURE 1. VOLTAGE-MODE BUCK CONVERTER COMPENSATION DESIGN

**Feedback Compensator**

Type-III network is recommended for compensating the feedback loop. Figure 1 shows Type-III compensation configuration for ISL8105B.

With the inductor and output capacitor selected as described in the previous sections, the poles and zero of the power stage can be summarized in Equation 15:

$$F_0 = \frac{1}{2 \times \pi \times \sqrt{L \times C}} = 3.7\text{kHz} \tag{EQ. 15}$$

$$F_{ESR} = \frac{1}{2 \times \pi \times C \times ESR} = 33.9\text{kHz}$$

1. With a value of 11.8k $\Omega$  for  $R_1$ , select  $R_4$  for the target output voltage of 1.8V using Equation 16:

$$R_4 = R_1 \times \frac{V_{ref}}{V_{OUT} - V_{ref}} = 5.9\text{k}\Omega \tag{EQ. 16}$$

2. With the desired feedback loop bandwidth of 30kHz,  $R_2$  can be calculated using Equation 17:

$$R_2 = \frac{V_{OSC} \cdot R_1 \cdot F_0}{d_{max} \cdot V_{IN} \cdot F_{LC}} = 12\text{k}\Omega \tag{EQ. 17}$$

3. Select  $C_1$  such that  $F_{Z1}$  is located at 1.5kHz (~50% of  $F_{LC}$ ):

$$C_1 = \frac{1}{2\pi \cdot R_2 \cdot 1.5 \times 10^3} \approx 10\text{nF} \tag{EQ. 18}$$

4. Select  $C_2$  such that  $F_{P1}$  is located at  $F_{ESR}$ :

$$C_2 = \frac{C_1}{2\pi \cdot R_2 \cdot C_1 \cdot F_{ESR} - 1} \approx 390\text{pF} \tag{EQ. 19}$$

5. Select  $R_3$  such that  $F_{Z2}$  is located at  $F_{LC}$ :

$$R_3 = \frac{R_1}{\frac{150 \times 10^3}{F_{LC}} - 1} \approx 301\Omega \tag{EQ. 20}$$

$$C_3 = \frac{1}{2\pi \cdot R_3 \cdot 150 \times 10^3} \approx 3.3\text{nF}$$

A more detailed explanation of designing compensation networks for buck converters with voltage mode control can be found in TB417 entitled "Designing Stable Compensation Networks for Single Phase Voltage Mode Buck Regulators".

**Evaluation Board Performance**

Figure 2 shows a photograph of the ISL8105BEVAL1Z.

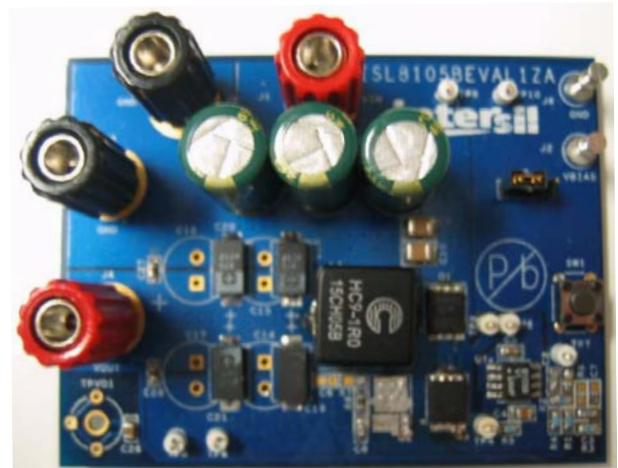

FIGURE 2. ISL8105BEVAL1Z

**Power and Load Connections**

Terminals J1 and J2 are connected to the input of the power stage. The IC bias supply and the converter input supply can be together through pin 2 and 3 of the Jumper J7 to provide single rail supply application. When using separate supplies, provide the IC bias voltage to terminal J2 with pin 2 and pin 1 of J7 connected together. The load can be connected to terminal J4 and J5. TP6 and TP3 can be used for DMM to measure output voltage. The scope probe terminal (TPV01) can be used to monitor  $V_{OUT}$  with an oscilloscope. The push switch, SW1, can be used to disable the controller.

### Start-up

The ISL8105B starts up when  $V_{BIAS}$  rises above POR threshold and the COMP/EN rises above  $V_{DISABLE}$  level. The entire start-up time sequence from POR typically takes up to 23.8ms; up to 10.2ms for the delay and the Overcurrent Protection (OCP) sample and hold operation. The initial delay is added to allow the bias voltage to rise/exceed 6.5V, so that the internal bias regulator can turn on cleanly. When the OCP sampling and hold operations are done, the soft-start function internally ramps the reference on the non-inverting terminal of the error amp from 0V to 0.6V in 13.6ms (typ).

Figure 3 shows the start-up profile of the ISL8105BEVAL1Z, ISL8105BEVAL2Z in relation to the start-up of the 12V input supply and the bias supply.

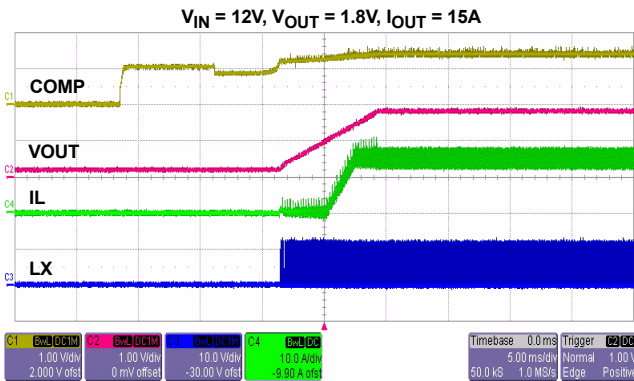

FIGURE 3. SOFT-START

### Soft-Start with Pre-Biased Output

If the output is pre-biased to a voltage less than the expected value, the ISL8105BEVAL1Z, ISL8105BEVAL2Z will detect that condition. Neither MOSFETs will turn on until the soft-start ramp voltage exceeds the FB voltage;  $V_{OUT}$  starts seamlessly ramping from there.

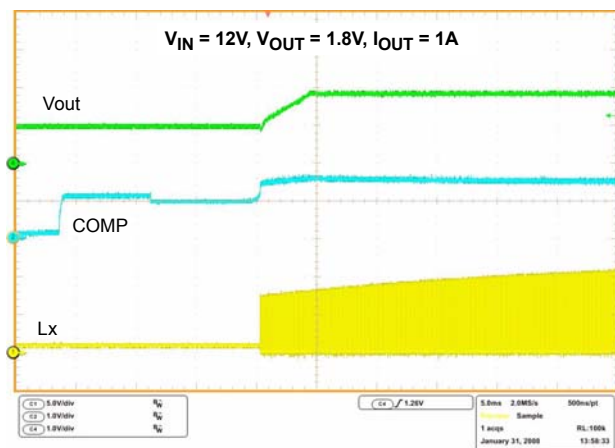

FIGURE 4. SOFT-START WITH PRE-BIASED OUTPUT

### Output Ripple

Figure 5 shows the ripple voltage on the output of the regulator.

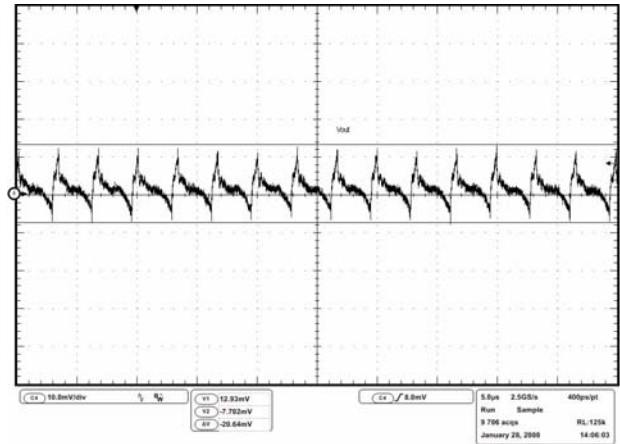

FIGURE 5. OUTPUT RIPPLE (20MHz BW)

### Verifying Loop Gain

Figure 6 shows the measurement of loop gain of the converter with feedback network design in the previous sections.

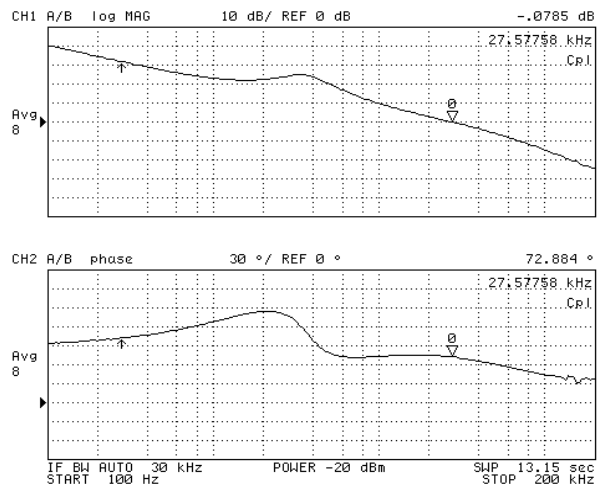

FIGURE 6. LOOP GAIN MEASUREMENT AT +25°C

### Transient Performance

Figures 7, 8, and 9 show the response of the output when subjected to transient loading from 0A to 15A at 1A/μs.

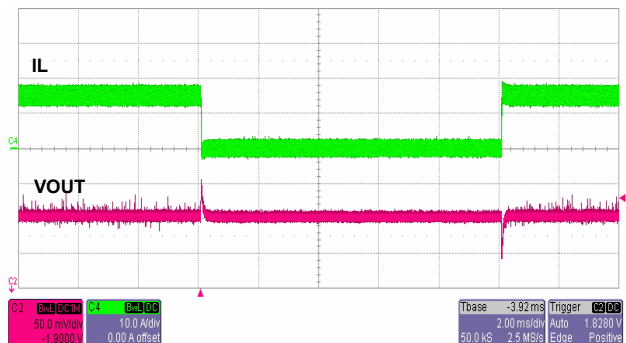

FIGURE 7. TRANSIENT RESPONSE

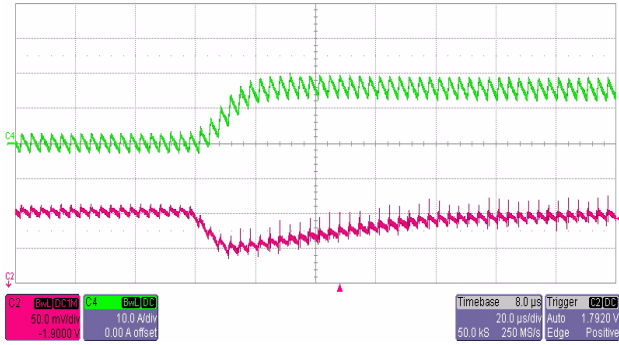

FIGURE 8. TRANSIENT RESPONSE

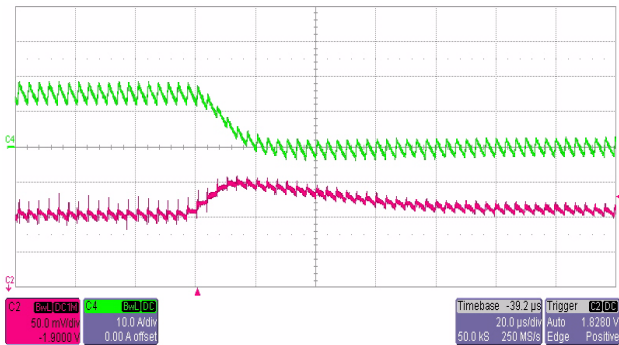

FIGURE 9. TRANSIENT RESPONSE

**Efficiency**

ISL8105BEVAL1Z, ISL8105BEVAL2Z based regulators enable the design of highly efficient systems. The efficiency of the evaluation board using a 12V input supply is shown in Figure 10.

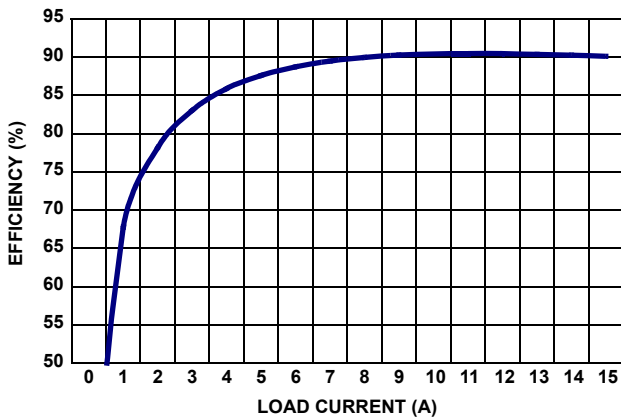

FIGURE 10. EVALUATION BOARD EFFICIENCY (V<sub>OUT</sub> = 1.8V)

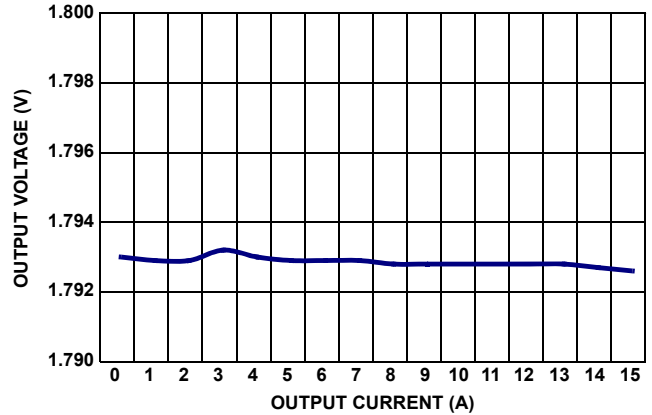

FIGURE 11. EVALUATION BOARD LINE REGULATION

**References**

For Intersil documents available on the web, go to <http://www.intersil.com/>.

1. ISL8105, ISL8105B Data Sheet, FN6306, “+5V or +12V Single-Phase Synchronous Buck Converter PWM Controller with Integrated MOSFET Gate Drivers”, Intersil Corporation
2. Tech Brief TB417, “Designing Stable Compensation Networks for Single Phase Voltage Mode Buck Regulators”, Intersil Corporation



**ISL8105BEVAL1Z Bill of Materials**

ID	REFERENCE	QTY	PART NUMBER	PART TYPE	DESCRIPTION	PACKAGE	VENDOR
1	U1	1	ISL8105BIBZ	IC, Linear	IC, Single PWM Controller	8 LD SOIC	Intersil
2	Q1	1	BSC080N30LS G	MOSFET	30V N-Channel MOSFET	TDSON-08	Infineon
3	Q3	1	BSC030N03LS G	MOSFET	30V N-Channel MOSFET	TDSON-08	Infineon
4	Q2, Q4, Q5, Q6	DNP		MOSFET			
5	L1	1	HC9-1R0-R	Inductor	1.0μH, high current inductor	SMD	Cooper Bussmann
6	SW1	1	EVQ-PAD04M	Push Switch	SWITCH-PUSH, TH, 6mm, 1P, PUSHB MOM-SPST		PANASONIC
<b>CAPACITORS</b>							
7	C1	1		Capacitor, Ceramic, X7R	10nF, 50V, 10%, ROHS	SM_0603	TDK/Generic
8	C2	1		Capacitor, Ceramic, X7R	390pF, 50V, 10%, ROHS	SM_0603	TDK/Generic
9	C3	1		Capacitor, Ceramic, X7R	3.3nF, 50V, 10%, ROHS	SM_0603	TDK/Generic
10	C4, C9, C10	3		Capacitor, Ceramic, X7R	1μF, 25V, 10%, X7R, ROHS	SM_0805	TDK/Generic
11	C5, C27, C28	3		Capacitor, Ceramic, X7R	0.1μF, 16V, 10%, ROHS	SM_0603	TDK/Generic
12	C8	1		Capacitor, Ceramic, X7R	680pF, 50V, 10%, ROHS	SM_0603	TDK/Generic
13	C11, C12, C13	3	35ME330AX	Aluminum Capacitor	330μF, 35V	RAD 10x20	Sanyo
14	C18, C19, C20, C21	4	2R5TPF470ML	Organic Alumium Capacitor	470μF, 2.5V, 20%, ROHS	Case D3L	Sanyo
15	C6, C7, C14, C15, C16, C17, C22, C23, C24, C25, C26	DNP					
<b>RESISTORS</b>							
16	R1	1		Resistor, Film	11.8kΩ, 1%, 1/16W	SM_0603	Panasonic/Generic
17	R2	1		Resistor, Film	12kΩ, 1%, 1/16W	SM_0603	Panasonic/Generic
18	R3	1		Resistor, Film	301Ω, 1%, 1/16W	SM_0603	Panasonic/Generic
19	R4	1		Resistor, Film	5.9kΩ, 1%, 1/16W	SM_0603	Panasonic/Generic
20	R5	1		Resistor, Film	1.74kΩ, 1%, 1/16W	SM_0603	Panasonic/Generic
21	R6	1		Resistor, Film	4.7Ω, 1%, 1/16W	SM_0603	Panasonic/Generic
22	R7, R8	DNP				SM_0603	
<b>OTHERS</b>							
23	TPVO1	DNP		Terminal, Scope Probe	CONN-PIN RECEPTACLE, 0.086 DIA, 0.200 L, ROHS		MILL-MAX
24	J1, J4	2	111-0702-001	Blinding Post	CONN-GEN, BIND. POST, RED, THMBNUT-GND		JOHNSON COMPONENTS
25	J3, J5	2	111-0703-001	Blinding Post	CONN-GEN, BIND. POST, BLACK, THMBNUT-GND		JOHNSON COMPONENTS
26	J2, J6	2	1514-2	Turrett Post	CONN-TURRET, TERMINAL POST, TH, ROHS		Keystone
27	J7	1	68000-236-1X3		3-pin Jumper		Berg/FCI
28	TP3, TP6, TP9, TP10	4	5002	Test Point	CONN-MINI TEST POINT, VERTICAL, WHITE, ROHS		Keystone
29	TP2, TP4, TP7, TP8	DNP	5002	Test Point	CONN-MINI TEST POINT, VERTICAL, WHITE, ROHS		Keystone

**ISL8105BEVAL1Z Printed Circuit Board Layers**

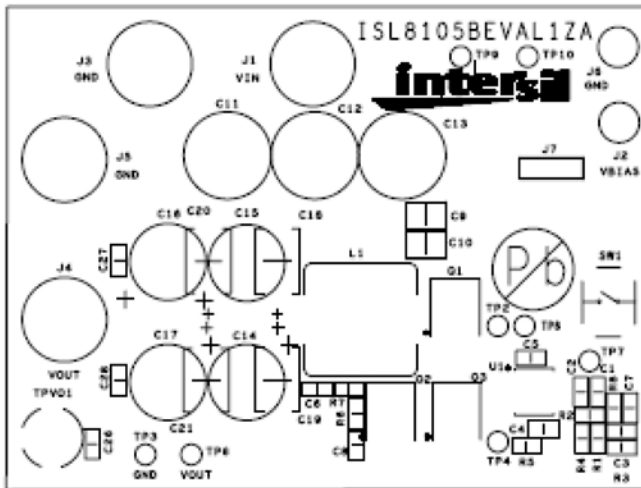

FIGURE 12. ISL8105BEVAL1Z - TOP LAYER (SILKSCREEN)

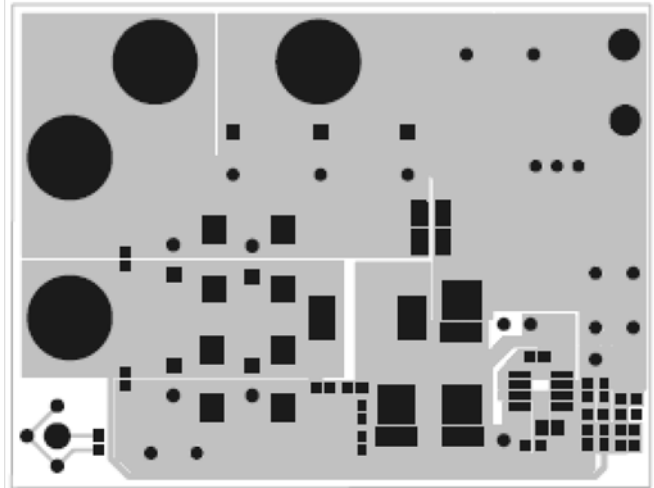

FIGURE 13. ISL8105BEVAL1Z - TOP LAYER (COMPONENT SIDE)

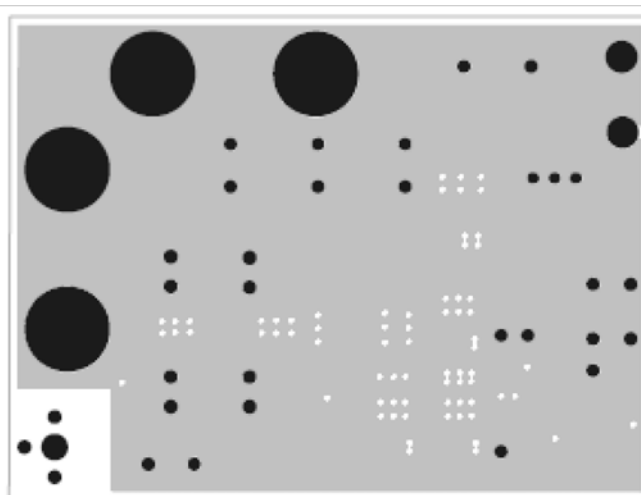

FIGURE 14. ISL8105BEVAL1Z - LAYER 2

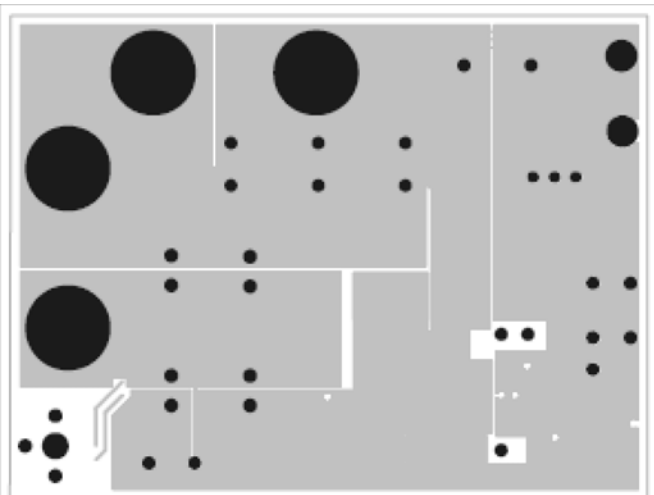

FIGURE 15. ISL8105BEVAL1Z - LAYER 3

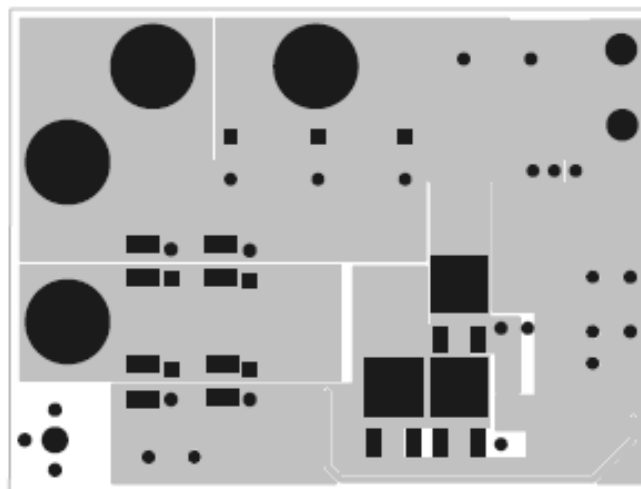

FIGURE 16. ISL8105BEVAL1Z - BOTTOM LAYER

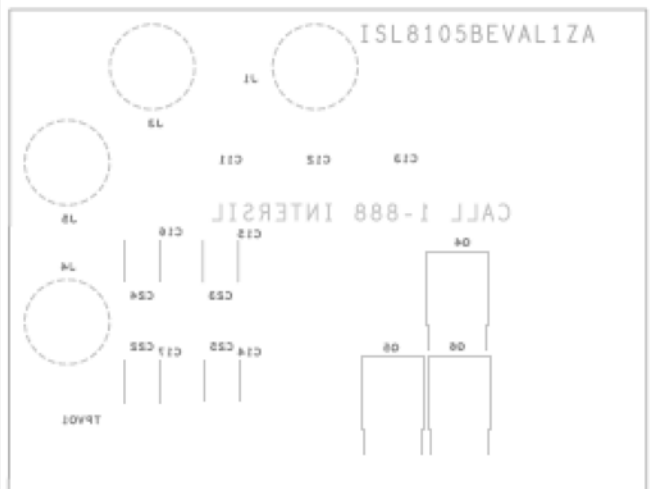

FIGURE 17. ISL8105BEVAL1Z - BOTTOM LAYER (SOLDER SIDE)





**ISL8105BEVAL2Z Bill of Materials**

ID	REFERENCE	QTY	PART NUMBER	PART TYPE	DESCRIPTION	PACKAGE	VENDOR
1	U1	1	ISL8105BIRZ	IC, Linear	IC, Single PWM Controller	10 LD DFN	Intersil
2	Q1	1	BSC080N30LS G	MOSFET	30V N-Channel MOSFET	TDSON-08	Infineon
3	Q3	1	BSC030N03LS G	MOSFET	30V N-Channel MOSFET	TDSON-08	Infineon
4	Q2, Q4, Q5, Q6	DNP		MOSFET			
5	L1	1	HC9-1R0-R	Inductor	1.0μH, high current inductor	SMD	Cooper Bussmann
6	SW1	1	EVQ-PAD04M	Push Switch	SWITCH-PUSH, TH, 6mm, 1P, PUSHB MOM-SPST		PANASONIC
<b>CAPACITORS</b>							
7	C1	1		Capacitor, Ceramic, X7R	10nF, 50V, 10%, ROHS	SM_0603	TDK/Generic
8	C2	1		Capacitor, Ceramic, X7R	390pF, 50V, 10%, ROHS	SM_0603	TDK/Generic
9	C3	1		Capacitor, Ceramic, X7R	3.3nF, 50V, 10%, ROHS	SM_0603	TDK/Generic
10	C4, C9, C10	3		Capacitor, Ceramic, X7R	1μF, 25V, 10%, X7R, ROHS	SM_0805	TDK/Generic
11	C5, C27, C28	3		Capacitor, Ceramic, X7R	0.1μF, 16V, 10%, ROHS	SM_0603	TDK/Generic
12	C8	1		Capacitor, Ceramic, X7R	680pF, 50V, 10%, ROHS	SM_0603	TDK/Generic
13	C11, C12, C13	3	35ME330AX	Aluminum Capacitor	330μF, 35V	RAD 10x20	Sanyo
14	C18, C19, C20, C21	4	2R5TPF470ML	Organic Alumium Capacitor	470μF, 2.5V, 20%, ROHS	Case D3L	Sanyo
15	C6, C7, C14, C15, C16, C17, C22, C23, C24, C25, C26	DNP					
<b>RESISTORS</b>							
16	R1	1		Resistor, Film	11.8kΩ, 1%, 1/16W	SM_0603	Panasonic/Generic
17	R2	1		Resistor, Film	12kΩ, 1%, 1/16W	SM_0603	Panasonic/Generic
18	R3	1		Resistor, Film	301Ω, 1%, 1/16W	SM_0603	Panasonic/Generic
19	R4	1		Resistor, Film	5.9kΩ, 1%, 1/16W	SM_0603	Panasonic/Generic
20	R5	1		Resistor, Film	1.74kΩ, 1%, 1/16W	SM_0603	Panasonic/Generic
21	R6	1		Resistor, Film	4.7Ω, 1%, 1/16W	SM_0603	Panasonic/Generic
22	R7, R8	DNP				SM_0603	
<b>OTHERS</b>							
23	TPVO1	DNP		Terminal, Scope Probe	CONN-PIN RECEPTACLE, 0.086 DIA, 0.200 L, ROHS		MILL-MAX
24	J1, J4	2	111-0702-001	Blinding Post	CONN-GEN, BIND. POST, RED, THMBNUT-GND		JOHNSON COMPONENTS
25	J3, J5	2	111-0703-001	Blinding Post	CONN-GEN, BIND. POST, BLACK, THMBNUT-GND		JOHNSON COMPONENTS
26	J2, J6	2	1514-2	Turrett Post	CONN-TURRET, TERMINAL POST, TH, ROHS		Keystone
27	J7	1	68000-236-1X3		3-pin Jumper		Berg/FCI
28	TP3, TP6, TP9, TP10	4	5002	Test Point	CONN-MINI TEST POINT, VERTICAL, WHITE, ROHS		Keystone
29	TP2, TP4, TP7, TP8	DNP	5002	Test Point	CONN-MINI TEST POINT, VERTICAL, WHITE, ROHS		Keystone

**ISL8105BEVAL2Z Printed Circuit Board Layers**

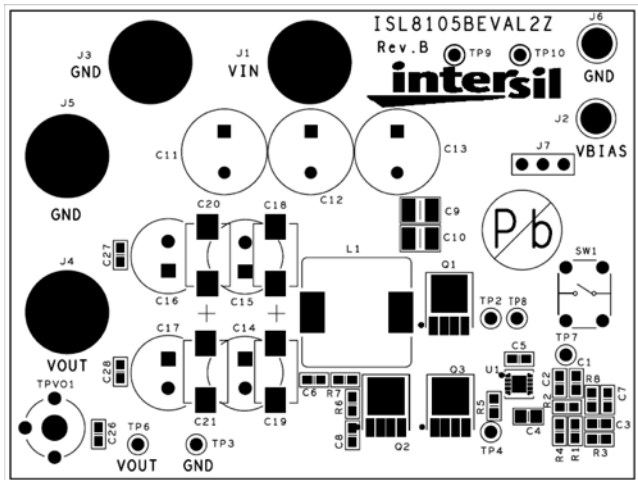

FIGURE 18. ISL8105BEVAL2Z - TOP LAYER (SILKSCREEN)

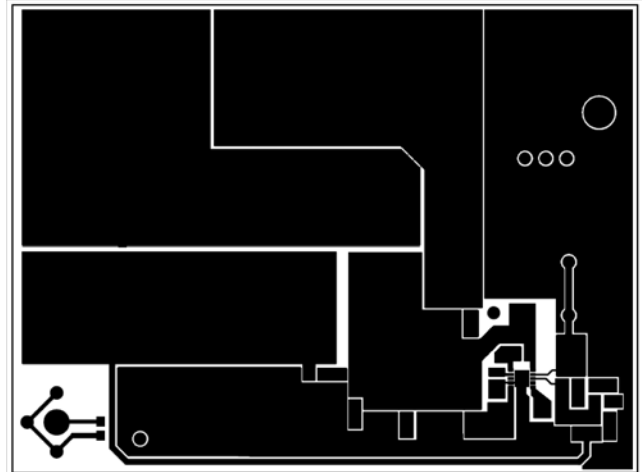

FIGURE 19. ISL8105BEVAL2Z - TOP LAYER (COMPONENT SIDE)

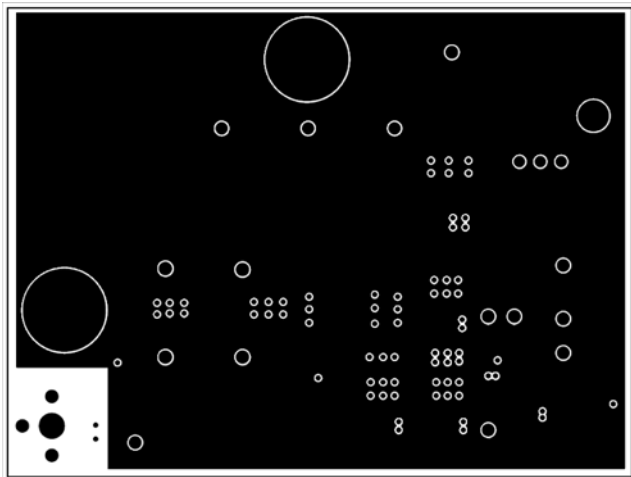

FIGURE 20. ISL8105BEVAL2Z - LAYER 2

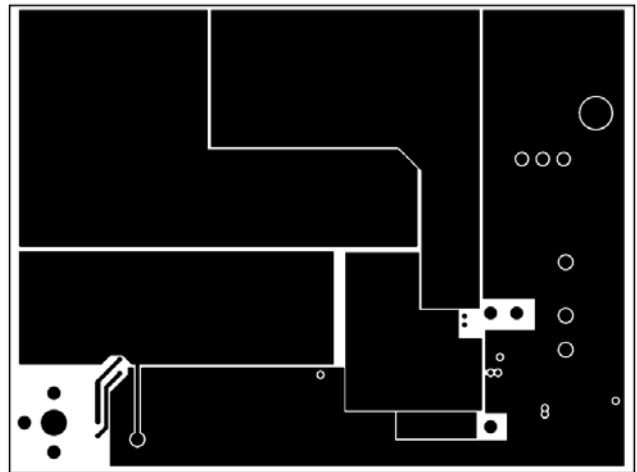

FIGURE 21. ISL8105BEVAL2Z - LAYER 3

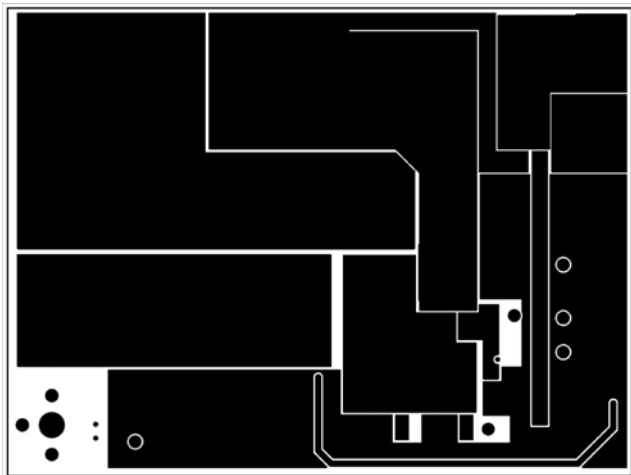

FIGURE 22. ISL8105BEVAL2Z - BOTTOM LAYER

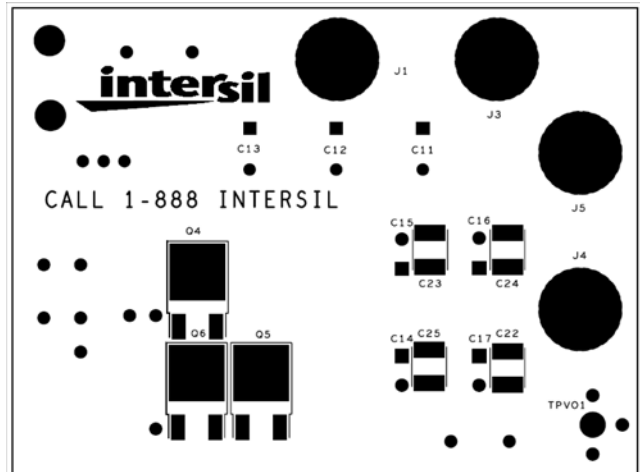

FIGURE 23. ISL8105BEVAL2Z - BOTTOM LAYER (SOLDER SIDE)

## Notice

1. Descriptions of circuits, software and other related information in this document are provided only to illustrate the operation of semiconductor products and application examples. You are fully responsible for the incorporation or any other use of the circuits, software, and information in the design of your product or system. Renesas Electronics disclaims any and all liability for any losses and damages incurred by you or third parties arising from the use of these circuits, software, or information.
2. Renesas Electronics hereby expressly disclaims any warranties against and liability for infringement or any other claims involving patents, copyrights, or other intellectual property rights of third parties, by or arising from the use of Renesas Electronics products or technical information described in this document, including but not limited to, the product data, drawings, charts, programs, algorithms, and application examples.
3. No license, express, implied or otherwise, is granted hereby under any patents, copyrights or other intellectual property rights of Renesas Electronics or others.
4. You shall not alter, modify, copy, or reverse engineer any Renesas Electronics product, whether in whole or in part. Renesas Electronics disclaims any and all liability for any losses or damages incurred by you or third parties arising from such alteration, modification, copying or reverse engineering.
5. Renesas Electronics products are classified according to the following two quality grades: "Standard" and "High Quality". The intended applications for each Renesas Electronics product depends on the product's quality grade, as indicated below.  
"Standard": Computers; office equipment; communications equipment; test and measurement equipment; audio and visual equipment; home electronic appliances; machine tools; personal electronic equipment; industrial robots; etc.  
"High Quality": Transportation equipment (automobiles, trains, ships, etc.); traffic control (traffic lights); large-scale communication equipment; key financial terminal systems; safety control equipment; etc.  
Unless expressly designated as a high reliability product or a product for harsh environments in a Renesas Electronics data sheet or other Renesas Electronics document, Renesas Electronics products are not intended or authorized for use in products or systems that may pose a direct threat to human life or bodily injury (artificial life support devices or systems; surgical implantations; etc.), or may cause serious property damage (space system; undersea repeaters; nuclear power control systems; aircraft control systems; key plant systems; military equipment; etc.). Renesas Electronics disclaims any and all liability for any damages or losses incurred by you or any third parties arising from the use of any Renesas Electronics product that is inconsistent with any Renesas Electronics data sheet, user's manual or other Renesas Electronics document.
6. When using Renesas Electronics products, refer to the latest product information (data sheets, user's manuals, application notes, "General Notes for Handling and Using Semiconductor Devices" in the reliability handbook, etc.), and ensure that usage conditions are within the ranges specified by Renesas Electronics with respect to maximum ratings, operating power supply voltage range, heat dissipation characteristics, installation, etc. Renesas Electronics disclaims any and all liability for any malfunctions, failure or accident arising out of the use of Renesas Electronics products outside of such specified ranges.
7. Although Renesas Electronics endeavors to improve the quality and reliability of Renesas Electronics products, semiconductor products have specific characteristics, such as the occurrence of failure at a certain rate and malfunctions under certain use conditions. Unless designated as a high reliability product or a product for harsh environments in a Renesas Electronics data sheet or other Renesas Electronics document, Renesas Electronics products are not subject to radiation resistance design. You are responsible for implementing safety measures to guard against the possibility of bodily injury, injury or damage caused by fire, and/or danger to the public in the event of a failure or malfunction of Renesas Electronics products, such as safety design for hardware and software, including but not limited to redundancy, fire control and malfunction prevention, appropriate treatment for aging degradation or any other appropriate measures. Because the evaluation of microcomputer software alone is very difficult and impractical, you are responsible for evaluating the safety of the final products or systems manufactured by you.
8. Please contact a Renesas Electronics sales office for details as to environmental matters such as the environmental compatibility of each Renesas Electronics product. You are responsible for carefully and sufficiently investigating applicable laws and regulations that regulate the inclusion or use of controlled substances, including without limitation, the EU RoHS Directive, and using Renesas Electronics products in compliance with all these applicable laws and regulations. Renesas Electronics disclaims any and all liability for damages or losses occurring as a result of your noncompliance with applicable laws and regulations.
9. Renesas Electronics products and technologies shall not be used for or incorporated into any products or systems whose manufacture, use, or sale is prohibited under any applicable domestic or foreign laws or regulations. You shall comply with any applicable export control laws and regulations promulgated and administered by the governments of any countries asserting jurisdiction over the parties or transactions.
10. It is the responsibility of the buyer or distributor of Renesas Electronics products, or any other party who distributes, disposes of, or otherwise sells or transfers the product to a third party, to notify such third party in advance of the contents and conditions set forth in this document.
11. This document shall not be reprinted, reproduced or duplicated in any form, in whole or in part, without prior written consent of Renesas Electronics.
12. Please contact a Renesas Electronics sales office if you have any questions regarding the information contained in this document or Renesas Electronics products.  
(Note 1) "Renesas Electronics" as used in this document means Renesas Electronics Corporation and also includes its directly or indirectly controlled subsidiaries.  
(Note 2) "Renesas Electronics product(s)" means any product developed or manufactured by or for Renesas Electronics.

(Rev.4.0-1 November 2017)



### SALES OFFICES

Renesas Electronics Corporation

<http://www.renesas.com>

Refer to "<http://www.renesas.com/>" for the latest and detailed information.

**Renesas Electronics America Inc.**  
1001 Murphy Ranch Road, Milpitas, CA 95035, U.S.A.  
Tel: +1-408-432-8888, Fax: +1-408-434-5351

**Renesas Electronics Canada Limited**  
9251 Yonge Street, Suite 8309 Richmond Hill, Ontario Canada L4C 9T3  
Tel: +1-905-237-2004

**Renesas Electronics Europe Limited**  
Dukes Meadow, Millboard Road, Bourne End, Buckinghamshire, SL8 5FH, U.K  
Tel: +44-1628-651-700, Fax: +44-1628-651-804

**Renesas Electronics Europe GmbH**  
Arcadiastrasse 10, 40472 Düsseldorf, Germany  
Tel: +49-211-6503-0, Fax: +49-211-6503-1327

**Renesas Electronics (China) Co., Ltd.**  
Room 1709 Quantum Plaza, No.27 ZhichunLu, Haidian District, Beijing, 100191 P. R. China  
Tel: +86-10-8235-1155, Fax: +86-10-8235-7679

**Renesas Electronics (Shanghai) Co., Ltd.**  
Unit 301, Tower A, Central Towers, 555 Langao Road, Putuo District, Shanghai, 200333 P. R. China  
Tel: +86-21-2226-0888, Fax: +86-21-2226-0999

**Renesas Electronics Hong Kong Limited**  
Unit 1601-1611, 16/F., Tower 2, Grand Century Place, 193 Prince Edward Road West, Mongkok, Kowloon, Hong Kong  
Tel: +852-2265-6688, Fax: +852-2886-9022

**Renesas Electronics Taiwan Co., Ltd.**  
13F, No. 363, Fu Shing North Road, Taipei 10543, Taiwan  
Tel: +886-2-8175-9600, Fax: +886-2-8175-9670

**Renesas Electronics Singapore Pte. Ltd.**  
80 Bendemeer Road, Unit #06-02 Hyflux Innovation Centre, Singapore 339949  
Tel: +65-6213-0200, Fax: +65-6213-0300

**Renesas Electronics Malaysia Sdn.Bhd.**  
Unit 1207, Block B, Menara Amcorp, Amcorp Trade Centre, No. 18, Jln Persiaran Barat, 46050 Petaling Jaya, Selangor Darul Ehsan, Malaysia  
Tel: +60-3-7955-9390, Fax: +60-3-7955-9510

**Renesas Electronics India Pvt. Ltd.**  
No.777C, 100 Feet Road, HAL 2nd Stage, Indiranagar, Bangalore 560 038, India  
Tel: +91-80-67208700, Fax: +91-80-67208777

**Renesas Electronics Korea Co., Ltd.**  
17F, KAMCO Yangjae Tower, 262, Gangnam-daero, Gangnam-gu, Seoul, 06265 Korea  
Tel: +82-2-558-3737, Fax: +82-2-558-5338