

# ***BUF16821EVM Evaluation Board and Software Tutorial***

This user's guide describes the characteristics, operation, and use of the BUF16821EVM evaluation board. It discusses how to set up and configure the software and hardware, and reviews various aspects of the program operation. Throughout this document, the terms *evaluation board*, *evaluation module*, and *EVM* are synonymous with the BUF16821EVM. This user's guide also includes information regarding operating procedures and input/output connections, an electrical schematic, PCB layout drawings, and a parts list for the EVM.

## **Contents**

1	Overview .....	2
2	Unpacking the EVM .....	2
3	BUF16821EVM Software .....	2
4	EVM Operation .....	5
5	Using the BUF16821EVM Software .....	8
6	Hardware and Schematic .....	18

## **List of Figures**

1	BUF16821EVM Software Installation .....	3
2	COM Port Selection and Dialog Window .....	3
3	BUF16821EVM Software <i>About</i> Button.....	4
4	BUF16821EVM Switch and Jumper Locations .....	5
5	BKSEL Switch .....	6
6	BUF16821EVM Jumper JP1 Set for Logic '1' .....	6
7	BUF16821EVM Jumper JP1 Set for Logic '0' .....	6
8	BUF16821EVM Jumper JP2 Set for BKSEL Switching.....	7
9	BUF16821EVM Jumper JP2 Set for External Signal Switching .....	7
10	BUF16821EVM Software GUI .....	8
11	Power Supply Measurement and Recording .....	9
12	Reset and Read DAC Buttons.....	10
13	Save to File Dialog Box .....	11
14	Working with a Saved BUF16821 Data File .....	12
15	Load From File Button .....	13
16	Changing the DAC Analog Voltage .....	14
17	Run Batch Dialog Box .....	15
18	Control Panel Button and Graphical Sliders .....	16
19	Program OTP All Channels Button .....	17
20	Program OTP Out Button and Write OTP Reg Dialog .....	17
21	Max Bank Field .....	18
22	BUF16821EVM Schematic.....	19
23	BUF16821EVM PCB Top Layer (Component Side).....	20
24	BUF16821EVM PCB Bottom Layer (Solder Side) .....	21

Pentium is a registered trademark of Intel Corporation.  
 Windows is a registered trademark of Microsoft Corporation.  
 I<sup>2</sup>C is a trademark of NXP Semiconductors, Inc.  
 WinZIP is a registered trademark of WinZip Computing, Inc.  
 All other trademarks are the property of their respective owners.

## 1 Overview

The BUF16821 is a programmable gamma-voltage generator and  $V_{COM}$  calibrator with integrated two-bank memory. This device offers 16 programmable gamma channels and two programmable  $V_{COM}$  channels. The BUF16821EVM is a platform for evaluating the performance of the [BUF16821](#) under various signal, reference, and supply conditions.

This document gives a general overview of the BUF16821EVM, and provides a general description of the features and functions to be considered while using this evaluation module.

## 2 Unpacking the EVM

Upon opening the BUF16821EVM kit, please check to make sure that the following items are included:

- One BUF16821EVM printed circuit board (PCB);
- One serial connection cable with RS-232/RJ-45 plug connector; (RS-232 and RJ-45 connectors)
- One CD containing the BUF16821EVM software, and electronic copies of the [BUF16821 product data sheet](#) and [this user's guide](#);

If any of these items are missing, please contact the Texas Instruments Product Information Center nearest you to inquire about a replacement.

## 3 BUF16821EVM Software

### 3.1 Hardware Requirements

The minimum hardware requirements for the BUF16821EVM software are:

- IBM PC-compatible computer running a Microsoft Windows® 98/ME/NT/2000/XP operating system
- Pentium® or equivalent processor
- 64MB of RAM
- Hard disk drive with at least 100MB free space
- Available COM port
- Mouse
- VGA adapter card and monitor

### 3.2 Installation

The BUF16821EVM software is included on the CD that is shipped with the EVM. It is also available through the [BUF16821EVM product folder](#) on the [TI web site](#). To download the software to your system, insert the disc into an available CD-ROM drive. Navigate to the drive contents and open the BUF16821EVM software folder. Locate the compressed file (*BUF16821EVM.zip*) and open it. Using WinZIP®, unzip the BUF16821EVM files into a specific BUF16821 folder on your hard drive.

Once the files are unzipped, navigate to the BUF16821 folder that you created on your hard drive. Locate the *setup.exe* file; click the file to start the installation process, as shown in [Figure 1](#).

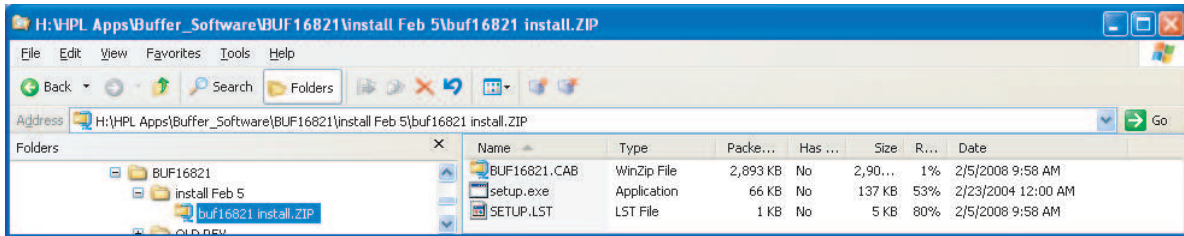

Figure 1. BUF16821EVM Software Installation

Follow all on-screen commands to finish installing the software.

### 3.3 Software Description and Set-Up

The EVM software is controlled through a graphical user interface (GUI). The software communicates with the EVM through an available COM or other serial port on the PC. Pressing the *COM Setting* button brings up a panel that allows you to change the serial port number through which the PC communicates with the BUF16821EVM, as shown in [Figure 2](#). COM1 is an appropriate choice for most PCs. You can also set the appropriate baud rate through the same dialog box.

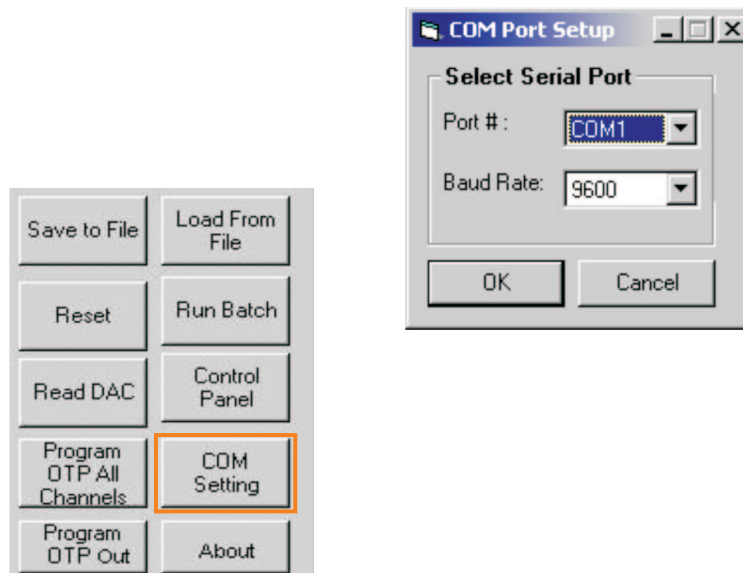
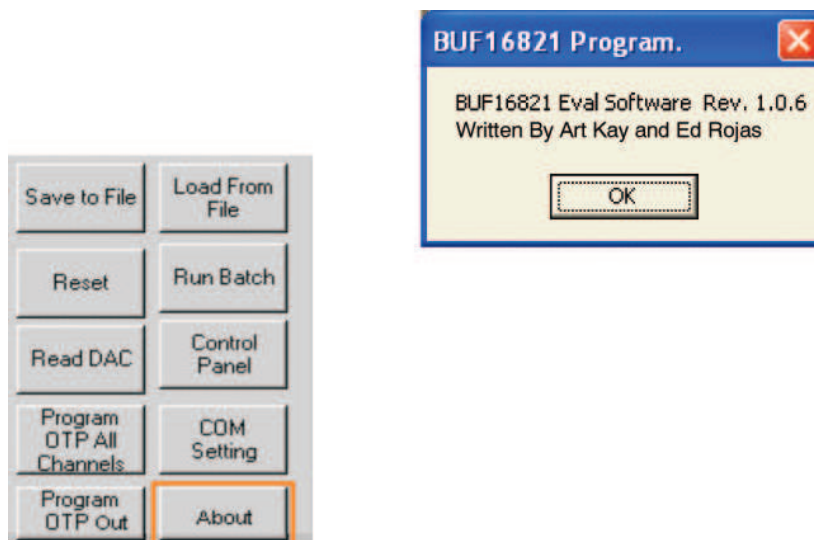

Figure 2. COM Port Selection and Dialog Window

The BUF16821EVM software allows the user to read and write to all registers in the BUF16821 gamma correction buffer. Furthermore, it allows programming of the OTP register on the BUF16821. The software also permits the user to select either I<sup>2</sup>C™ address.

Press the *About* button as shown in [Figure 3](#) to verify that you have the latest version of the software.



**Figure 3. BUF16821EVM Software *About* Button**

## 4 EVM Operation

Figure 4 shows the BUF16821EVM with the test point, switch, and jumper locations noted.

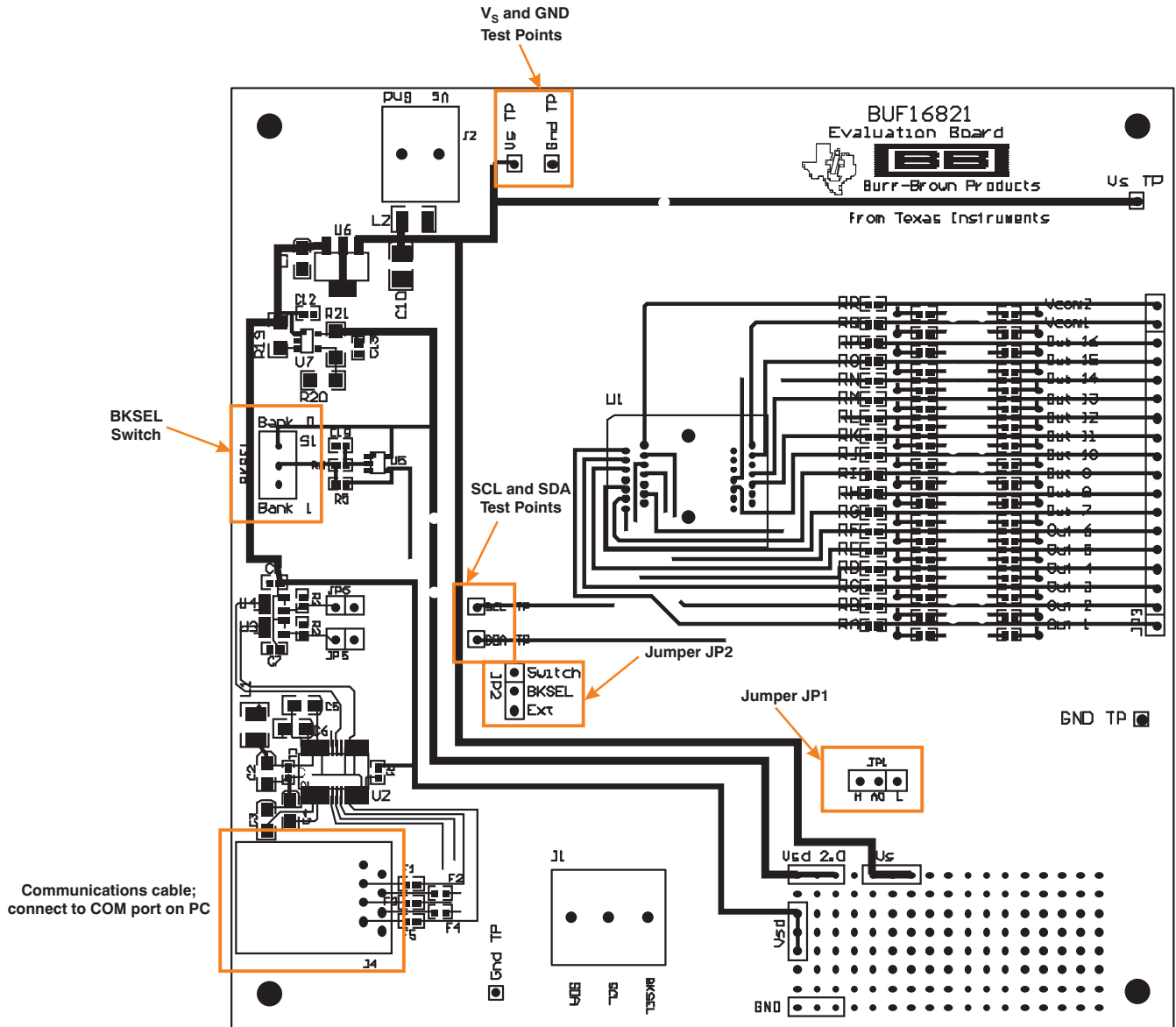

Figure 4. BUF16821EVM Switch and Jumper Locations

### 4.1 BKSEL

The BKSEL switch (illustrated in [Figure 5](#)) selects the memory bank to be used when operating the EVM. *Bank 1* selects the gamma curve that is stored in Bank\_0 of the BUF16821. *Bank 2* selects the gamma curve that is stored in Bank\_1 of the BUF16821.

The SCL and SDA jumpers must be installed on the EVM in order to allow communication between the board and the BUF16821. The communications cable must be connected to COM1 or another COM port on your PC.



**Figure 5. BKSEL Switch**

### 4.2 JP1

Jumper JP1 is used to set the I<sup>2</sup>C address pin of the BUF16821 to logic high or logic low. When J1 is in the position shown in [Figure 6](#), A0 on the BUF16821 is connected to DV<sub>DD</sub> (logic '1'). Note that the software *Change Address* button must be as shown in [Figure 6](#) for A0 = '1'.

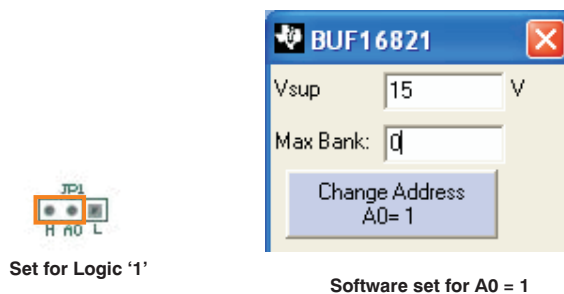

**Figure 6. BUF16821EVM Jumper JP1 Set for Logic '1'**

When JP1 is in the position shown in [Figure 7](#), A0 on the BUF16821 is connected to GND (logic '0'). Note that the software must be as shown in [Figure 7](#) for an address of A0 = '0'.

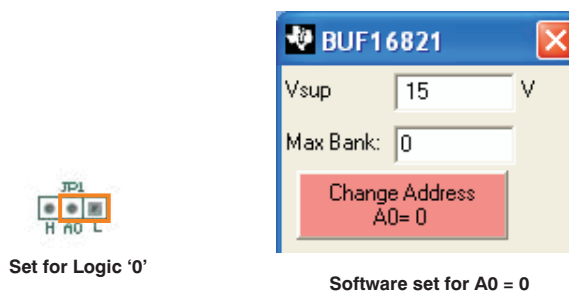

**Figure 7. BUF16821EVM Jumper JP1 Set for Logic '0'**

### 4.3 JP2

Jumper JP2 selects either the BKSEL switch on the EVM or an external signal to switch between the two nonvolatile memory banks of the BUF16821. When JP2 is in the position shown in [Figure 8](#), the BKSEL switch is used to switch between the memory banks.

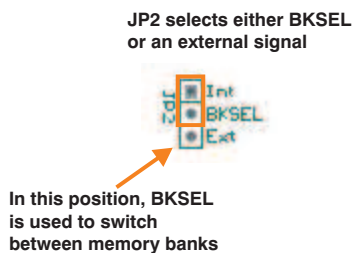

**Figure 8. BUF16821EVM Jumper JP2 Set for BKSEL Switching**

When JP2 is in the position shown in [Figure 9](#), the memory banks are switched according to the external signal applied via the connector.

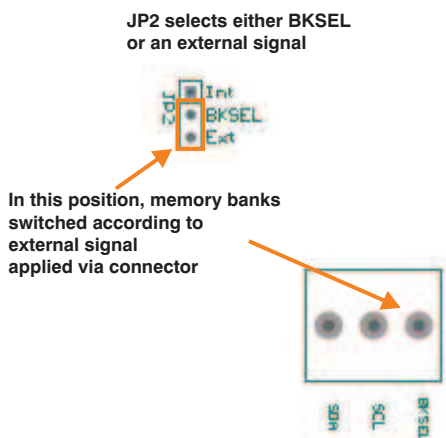

**Figure 9. BUF16821EVM Jumper JP2 Set for External Signal Switching**

## 5 Using the BUF16821EVM Software

Figure 10 shows the EVM software interface.

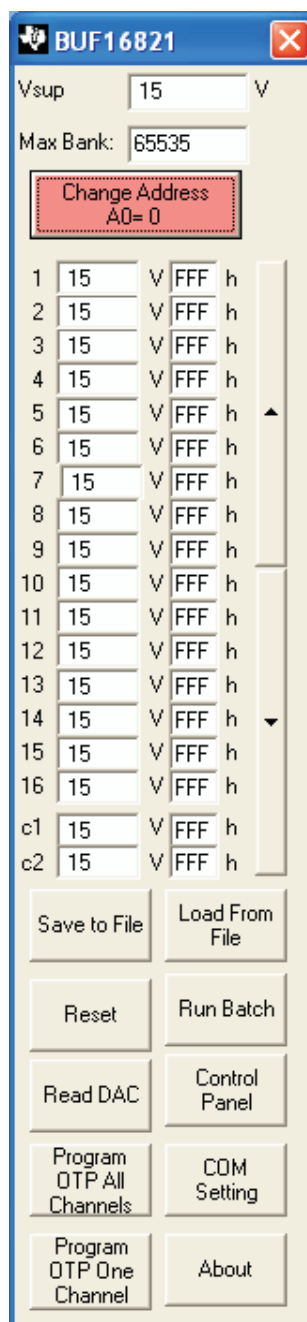

Figure 10. BUF16821EVM Software GUI



### 5.1 Change Address Button

Pressing the *Change Address* button (located near the top of the interface) changes the I<sup>2</sup>C address that the software writes to. In [Figure 10](#), the address is A0 = '0'. Pressing the button changes it to A0 = '1'. Note that the *Change Address* button is color-coded to help you quickly identify the current address. Red indicates that the address is A0 = '0'.

The interface also displays the last power-supply value used for the new address. This feature is helpful when changing back to an address that was previously used.

Whenever the address is changed, a Read DAC command is automatically performed so that all the DAC output displays are updated.

### 5.2 Measuring the Power Supply

You must measure the power supply ( $V_S$ ) value against GND, and then enter it in the  $V_{sup}$  field of the software interface, as shown in [Figure 11](#). The voltage out of each DAC is calculated according to the  $V_S$  value entered.

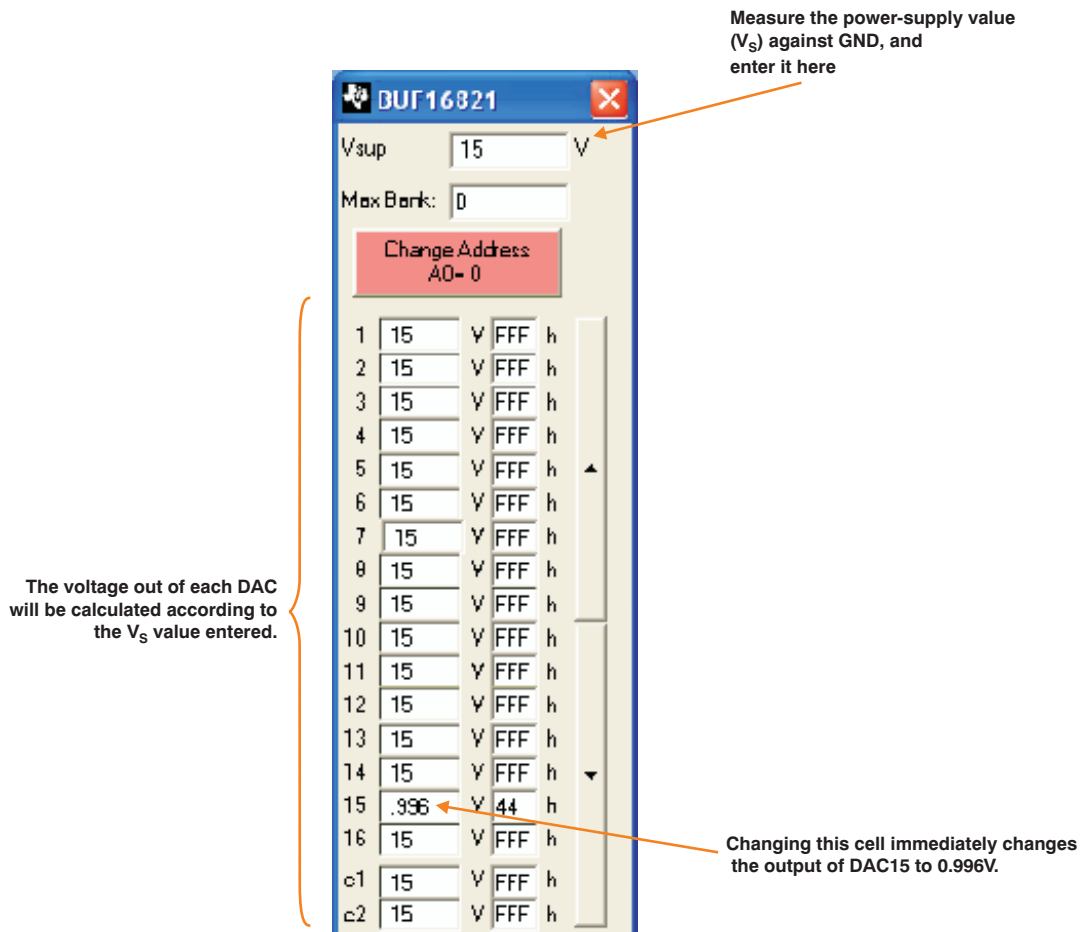

Figure 11. Power Supply Measurement and Recording

Measure  $V_S$  at the location indicated in [Figure 4](#).

For example, changing the value in the DAC 15 cell immediately changes the output of DAC15 to 0.996V. The calculation is performed according to [Equation 1](#).

$$V_{\text{DAC\_CHANNEL}} = \frac{V_S \times \text{Code\_in\_decimal}}{1024} \quad (1)$$

For example:

DAC 15: Code 44 (hexadecimal) = 68 (decimal)

$$V_{\text{DAC\_CHANNEL}} = 15V \times 68 / 1024 = 0.996V$$

### 5.3 Reset and Read DAC Buttons

Push the *ReadDAC* button to read the binary value in the DAC output registers of the BUF16821. Pushing the *Reset* button forces an I<sup>2</sup>C general call reset and causes all registers in the BUF16821 to reset to the respective default values (mid-code or  $V_S/2$ ). [Figure 12](#) illustrates the Reset and Read DAC buttons.

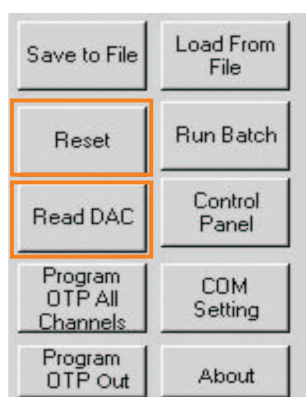

**Figure 12. Reset and Read DAC Buttons**

### 5.4 Save to File

The register configurations of the BUF16821 DACs are displayed in both analog voltage and in hexadecimal (see [Figure 11](#)). The DAC codes (that is, gamma voltages) can be saved into a text file using the *Save to File* button.

Pressing the Save to File button opens a file-save dialog box similar to that shown in Figure 13. Pressing the folder icon creates a new folder on your PC. It is a good idea to create a directory exclusively for BUF16821 DAC code (gamma voltage) files. Enter a unique file name in the *File name* field to store your BUF16821 register information. Press the *Open* button to save the file.

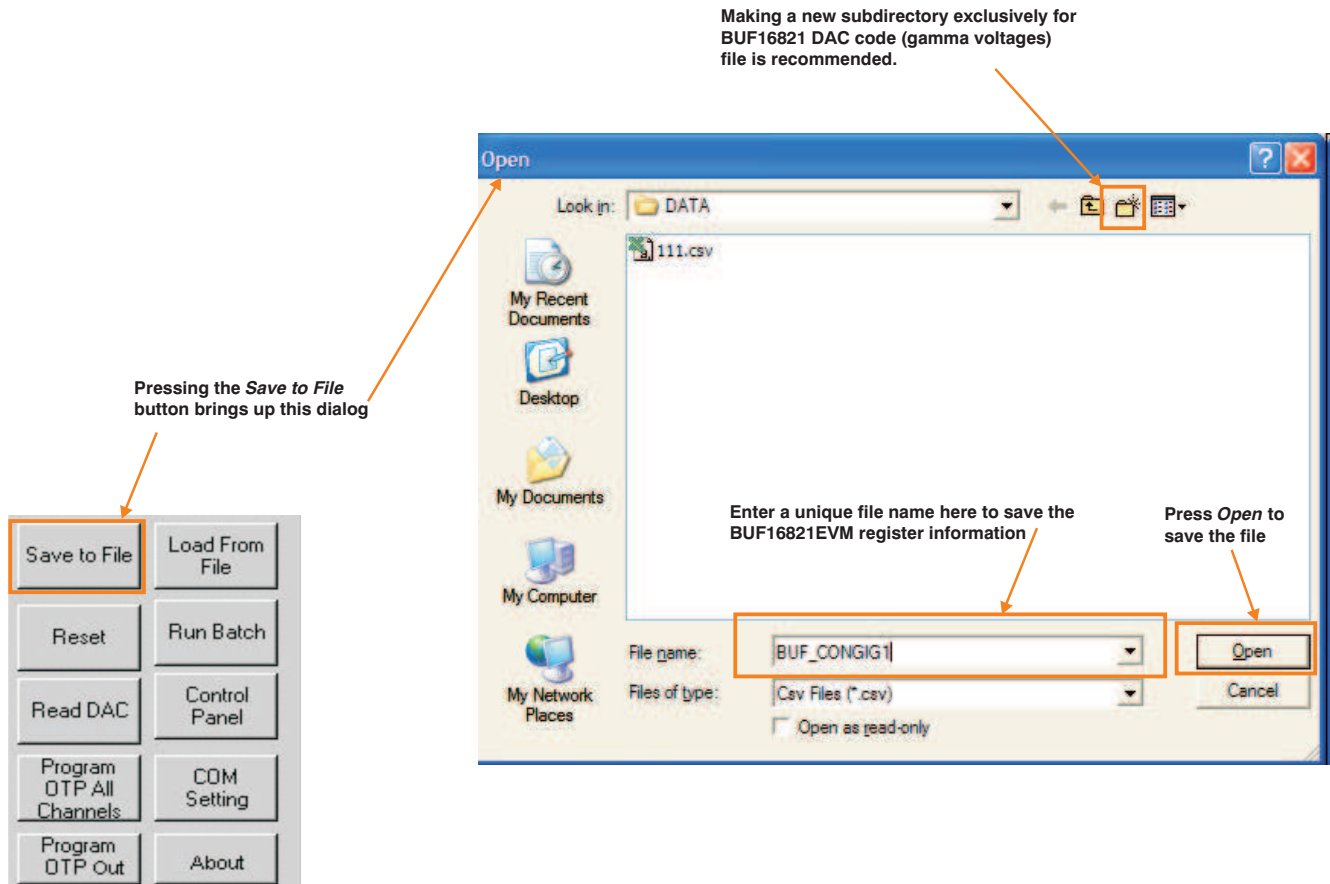
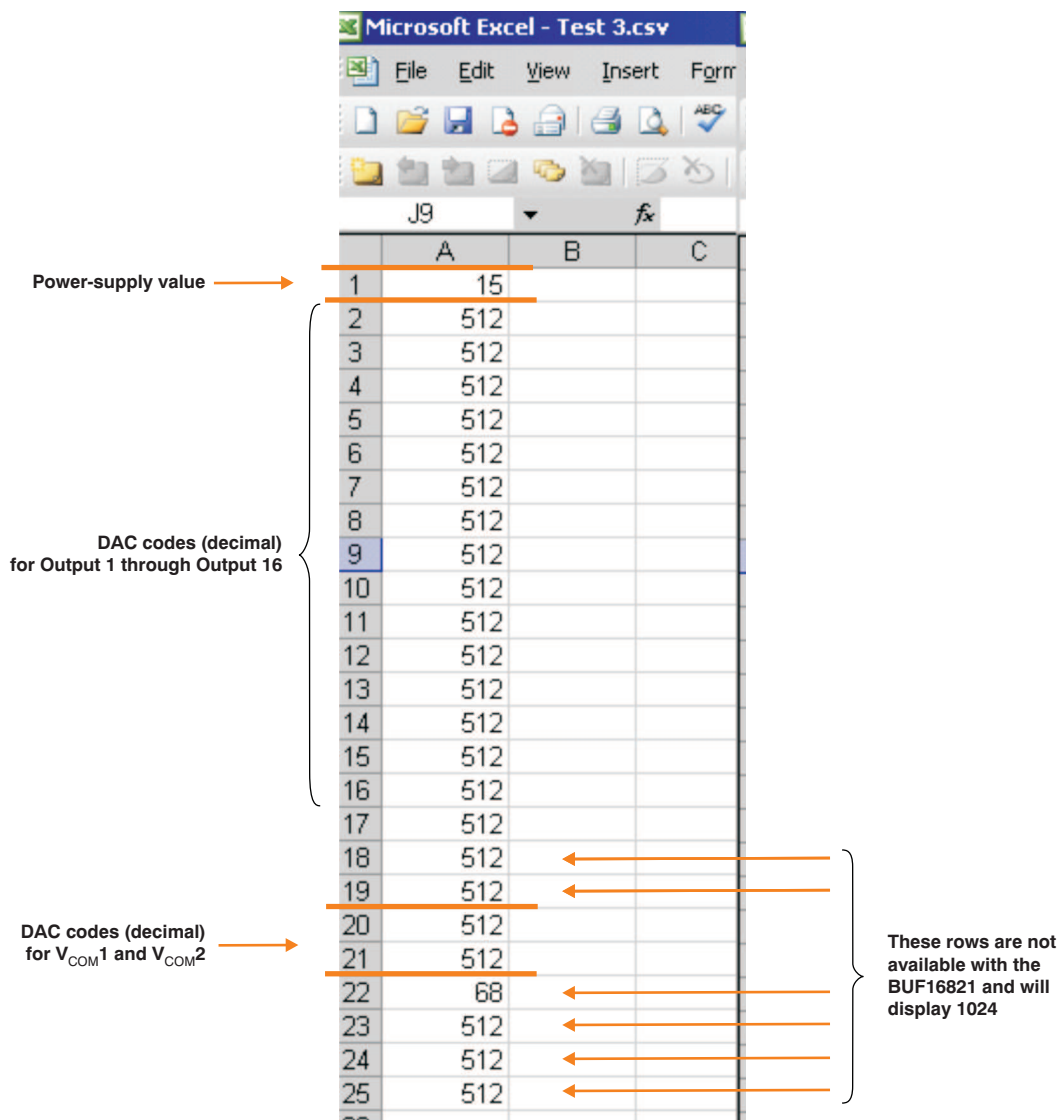

Figure 13. Save to File Dialog Box

Saving the BUF16821 DAC codes (gamma voltages) creates a text file that can be opened in a spreadsheet program or text editor, as illustrated in Figure 14.



**Figure 14. Working with a Saved BUF16821 Data File**

The first entry in the file is the power-supply value. Fields 2 through 17 contain the DAC codes (decimal) for Outputs 1 through 16. Fields 20 and 21 contain the DAC codes (decimal) for  $V_{COM1}$  and  $V_{COM2}$ .

## 5.5 Loading a Saved Data File

The BUF16821EVM software is also able to load data saved from previous evaluations. A saved register configuration can be loaded into the BUF16821 using the *Load From File* button, shown in Figure 15. The program remembers where you saved the last register configuration. Simply select the desired configuration and press *Open*.

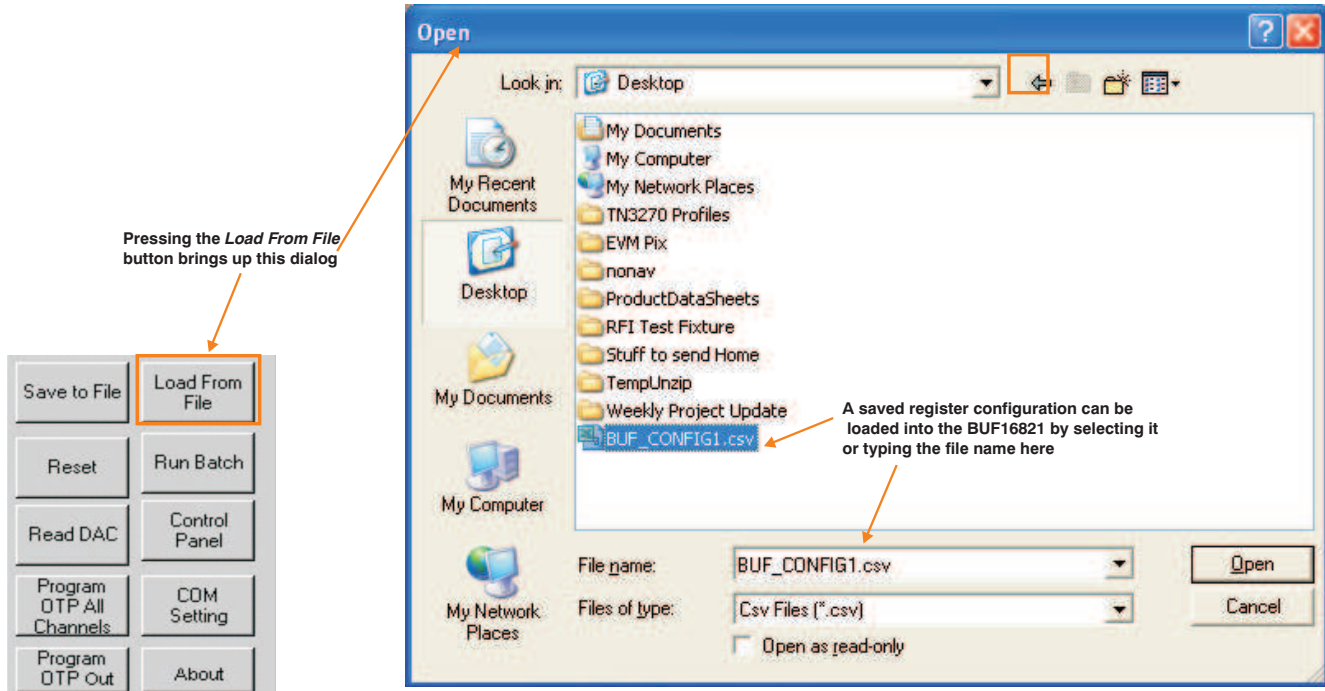
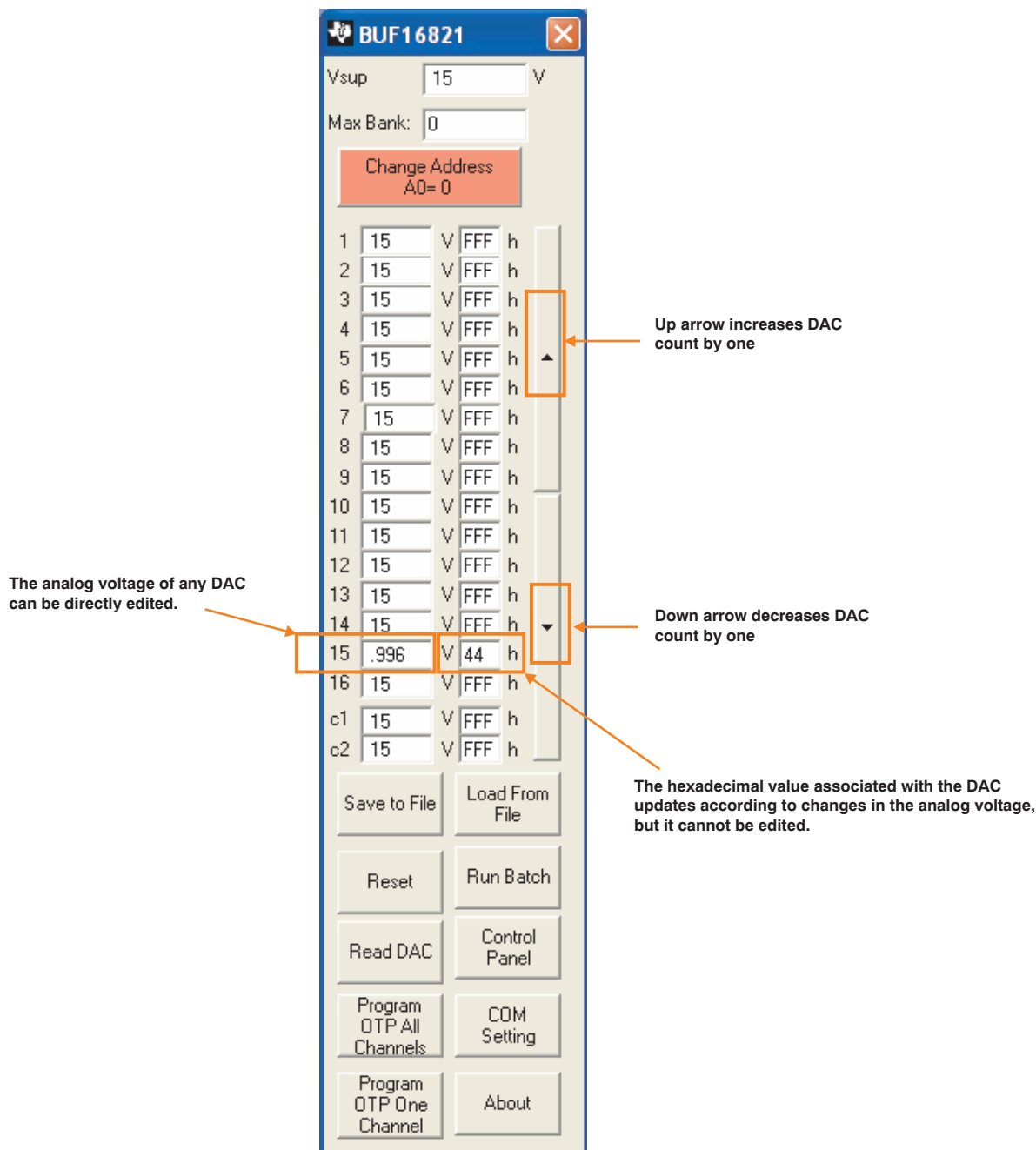

Figure 15. Load From File Button

## 5.6 Changing the DAC Analog Voltage

The analog voltage of any DAC can be directly edited, as Figure 16 shows.



**Figure 16. Changing the DAC Analog Voltage**

Note, however, that the hexadecimal value associated with the DAC updates according to changes in the analog voltage, but it cannot be directly edited.

If you select a DAC and click on the up arrow control, the DAC register increases by one count. Conversely, clicking on the down arrow control decreases the DAC register by one count.

## 5.7 Run Batch Button

The *Run Batch* button (as noted in [Figure 17](#)) enables the user to configure the BUF16821 to cycle through different register configurations in a continuous loop. When connected to the end application, this feature can be used to cycle through different gamma settings to determine what the optimal settings must be for a given application.

When the Run Batch button is pressed, a new dialog box displays, as shown in [Figure 17](#). The delay time is the amount of time in between loading new configurations into the BUF16821.

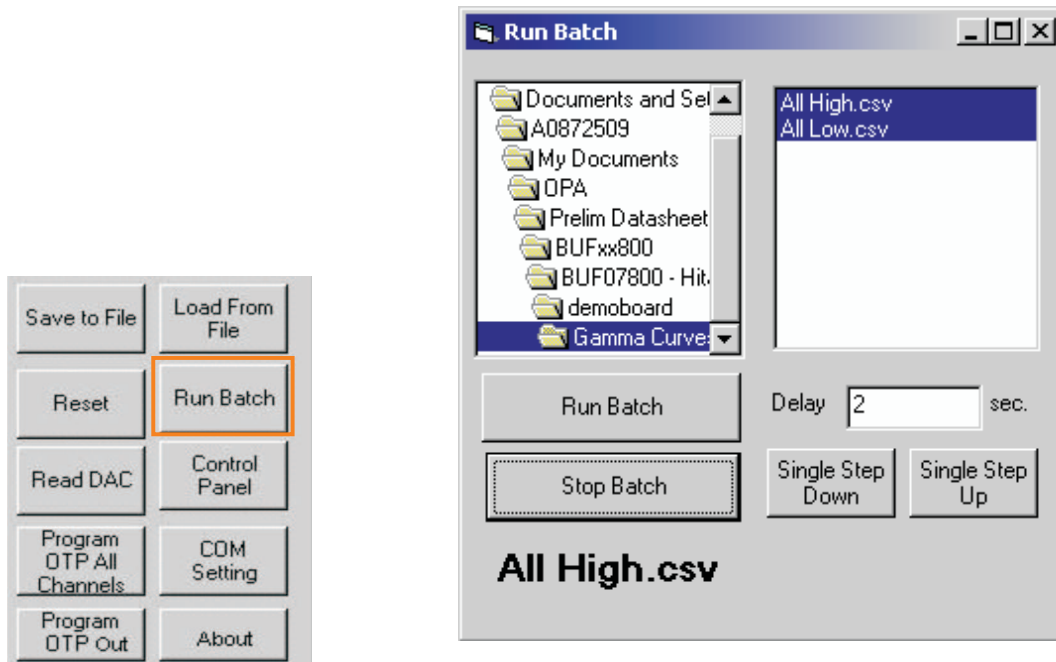

**Figure 17. Run Batch Dialog Box**

Use the *Single Step Up* and *Single Step Down* buttons to step through the selected files manually. The currently-selected file name is displayed in the lower left corner area of the dialog box. Press the <Shift> key and click on the files you want to select. In [Figure 17](#), two configuration files are selected.

## 5.8 Control Panel

Pressing the *Control Panel* button brings up a display panel that allows you to adjust each channel using a set of graphical sliders, as shown in Figure 18. Simply drag the slider to adjust the desired channel output. The DAC output value changes automatically.

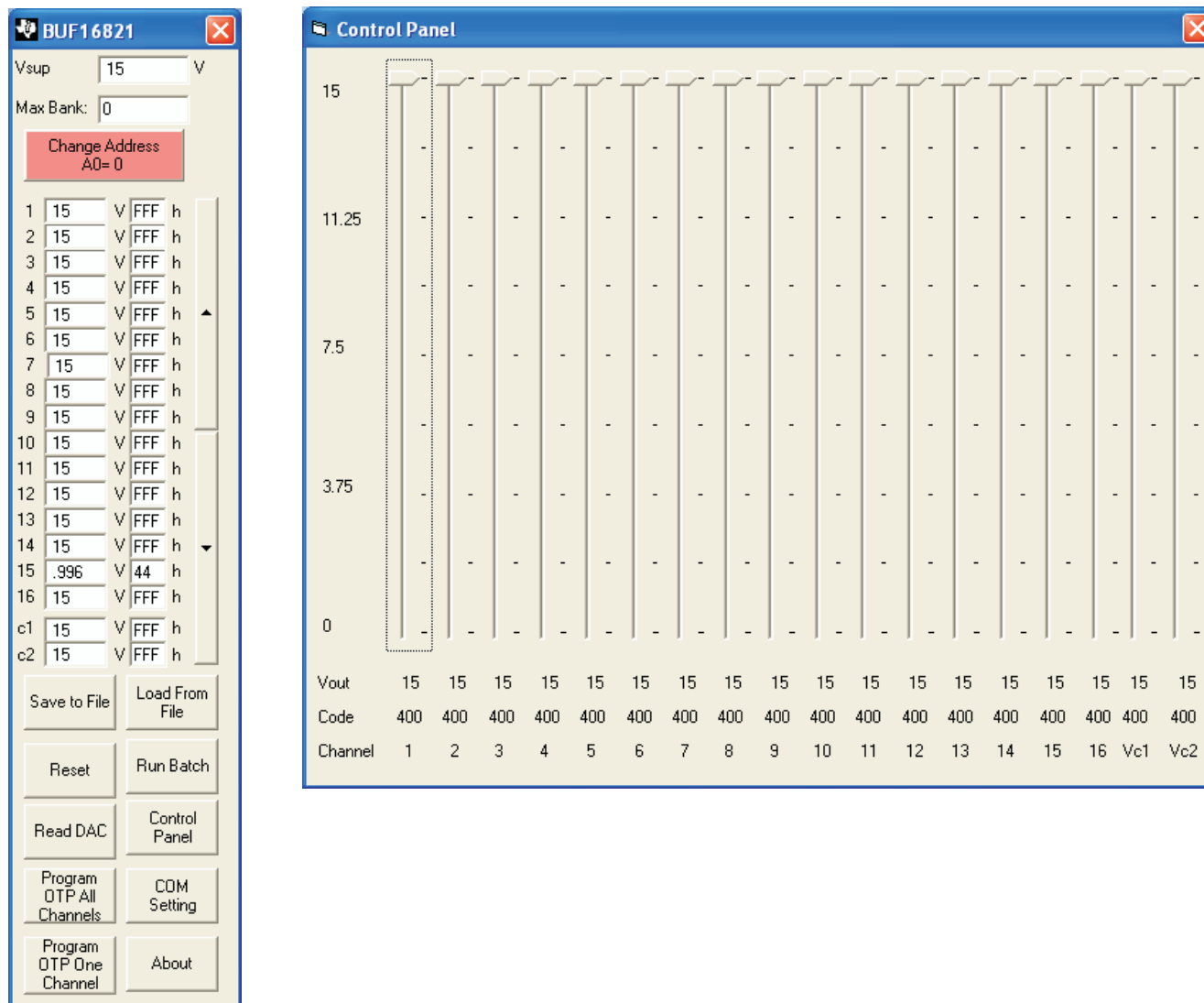

Figure 18. Control Panel Button and Graphical Sliders



### 5.9 Program OTP All Channels Button

As Figure 19 shows, pressing the *Program OTP All Channels* button allows you to program a gamma curve into the nonvolatile memory in the BUF16821. All 16 channels (including the  $V_{COM}$  channels) are then programmed simultaneously. The values are stored in the memory bank that is selected via the BKSEL switch (see Section 4.1).

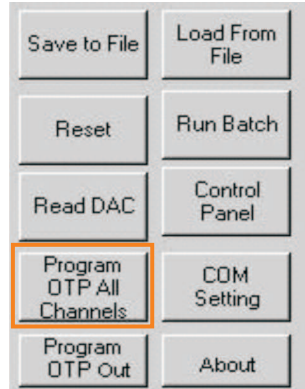

Figure 19. Program OTP All Channels Button

### 5.10 Program OTP Out Button

Pressing the *Program OTP Out* button (illustrated in Figure 20) allows you to store the value of a specific channel into the nonvolatile memory in the BUF16821. This feature is useful when the  $V_{COM}$  channels must be programmed at different times. The values are stored in the memory bank that is selected via the BKSEL switch. The *Write OTP Reg* dialog box appears.

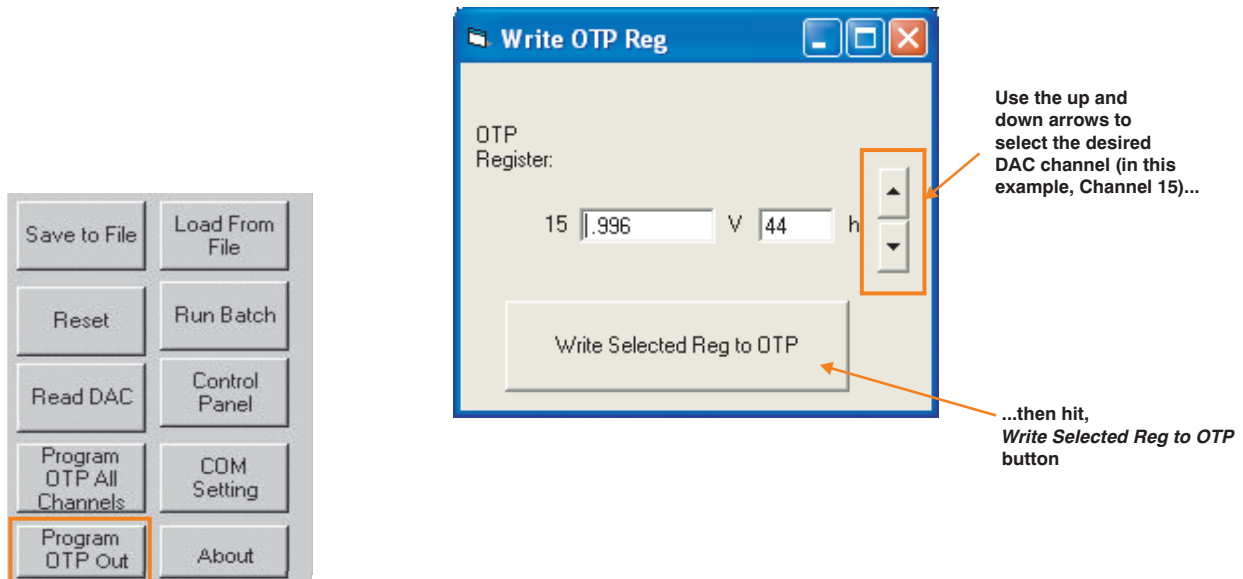

Figure 20. Program OTP Out Button and Write OTP Reg Dialog

In the example shown in Figure 20, to program 0.996V into the nonvolatile memory of channel 15, use the up and down arrows to select channel 15. Then press the *Write Selected Reg to OTP* button.

### 5.11 Max Bank Field

The *Max Bank* field at the top of the software interface (see [Figure 21](#)) shows how many times the memory of the most-programmed channel of the selected memory bank has been previously written.

- None: Max Bank shows **0**.
- Once: Max Bank shows **0**.
- Twice: Max Bank shows **1**.
- Three times: Max Bank shows **2**.
- 16 times: Max Bank shows **15**.

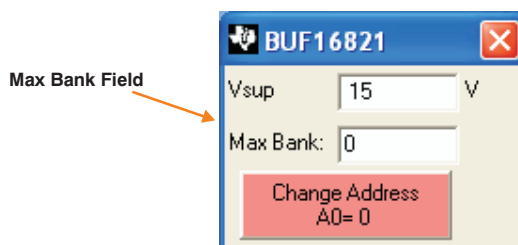

**Figure 21. Max Bank Field**

## 6 Hardware and Schematic

This section contains the complete bill of materials, schematic diagram, and PCB layouts for the BUF16821EVM.

---

**Note:** Board layouts are not to scale. These are intended to show how the board is laid out; they are not intended to be used for manufacturing BUF16821EVM PCBs.

---

## 6.1 Schematic

Figure 22 shows the schematic for the BUF16821EVM.

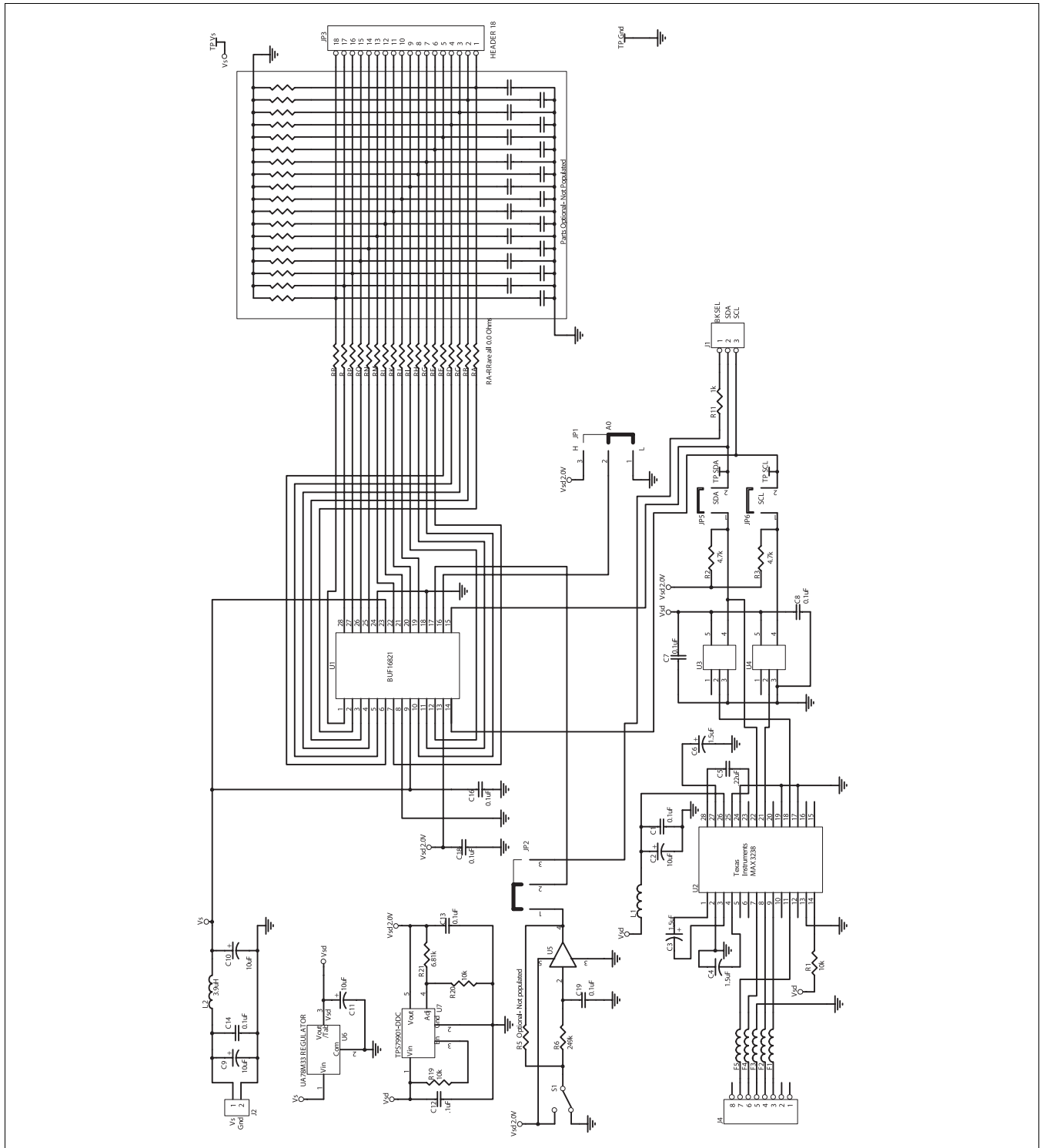

Figure 22. BUF16821EVM Schematic



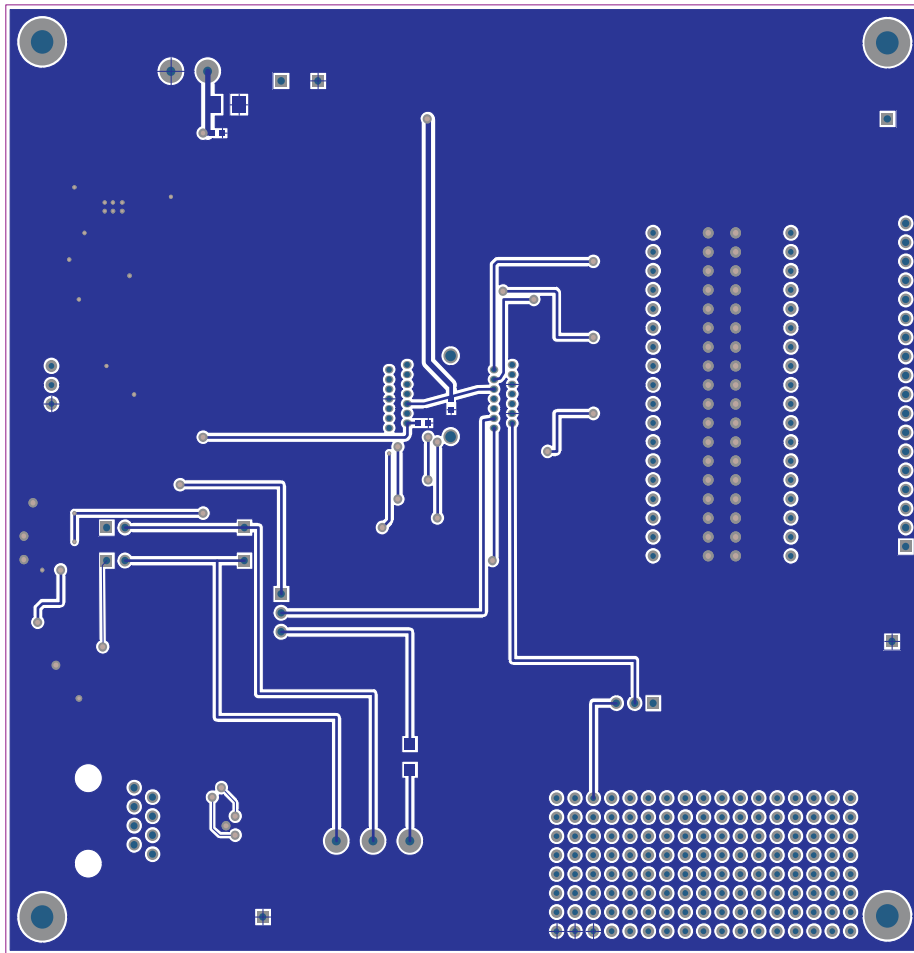

Figure 24. BUF16821EVM PCB Bottom Layer (Solder Side)

### 6.3 Bill of Materials

Table 1 lists the bill of materials for this EVM.

**Table 1. Bill of Materials**

Count	Value	RefDes	Description	Part Number	MFR
1	10kΩ	R1	Resistor, 10kΩ 603 size	CRCW060310K0FKEA	Vishay/Dale
2	10kΩ	R19, R20	Resistor, 10kΩ 1206 size	CRCW120610K0FKEA	Vishay/Dale
2	4.7kΩ	R2, R3	Resistor, 4.7kΩ 603 size	CRCW06034K70FKEA	Vishay/Dale
1	6.81kΩ	R21	Resistor, 6.81kΩ 1206 size	CRCW12066K81FKEA	Vishay/Dale
0		R5	Resistor, 603 size, OPTIONAL- NOT NORMALLY INSTALLED		
1	249kΩ	R6	Resistor, 249kΩ 603 size	CRCW0603249KFKEA	Vishay/Dale
1	1kΩ	R11	Resistor, 1kΩ 1206 size	CRCW12061K00FKEA	Vishay/Dale
18	0.0Ω	RA-RR	Resistor, 0.0Ω 603 size	CRCW06030000Z0EA	Vishay/Dale
9	0.1μF	C1, C7-C8, C12-C14, C16, C18-C19	Capacitor, Ceramic, 0.1μF, 603 size	C1608X7R1E104K	TDK Corp
2	10μF	C2, C11	Capacitor, Tantalum, 10μF, 10V, SMT 3216 "A"	T491A106K010AT	Kemet
3	1.5μF	C3, C4, C6	Capacitor, Tantalum, 1.5μF, 16V, SMT 3216 "A"	T491A155K016AT	Kemet
1	0.22μF	C5	Capacitor, Ceramic, 0.22μF, 1206	C1608X7R1C224K	TDK Corp
2	10μF	C9, C10	Capacitor, Tantalum, 10μF, 20V, SMT 3528 "B"	B45196H4106M209	Kemet
5		F1-F5	Ferrite Bead, 600Ω at 100MHz, SM 0603	HZ0603C601R-10	Steward
1	150μH	L1	INDUCTOR, 150UH 1210 SMD 10%	ELJ-FA151KF	Panasonic
1	3.9μH	L2	INDUCTOR, 3.9UH 1210 SMD 10%	ELJ-FA3R9KF	Panasonic
1		U1	Socket, TSSOP 28 Pin ZIF	OTS-28(28)-0.65-01	ENPLAS
1		U2	IC, 3V to 5.5V MultiChannel RS-232 Line Driver/Receiver, TSSOP-28	MAX3238CPWR	Texas Instruments
1		U3, U4	IC, Single Buffer/Driver w/Open Drain Out, SOT23-5	SN74LVC1G07DB	Texas Instruments
1		U5	IC, Single Buffer, Schmitt Trigger, SOT23-5	SN74LVC1G17DB	Texas Instruments
1		U6	IC, Voltage Regulator, 3.3V, SOT223-4	UA78M33CDCYR	Texas Instruments
1		U7	IC, Voltage Regulator, adjustable, TSOT23-5	TPS79901-DDC	Texas Instruments
1		S1	Switch, Toggle, SPDT, .4VA, PC Mount	200AWMSP1T1A1M2RE	E-Switch
7		XXXX TP	Terminal Strip, 1 position, .100 centers, .025 square pins	TSW-101-07-G-S	Samtec
2		JP2, JP2	Terminal Strip, 3 position, .100 centers, .025 square pins	TSW-103-07-G-S	Samtec
1		JP3	Terminal Strip, 18 position, .100 centers, .025 square pins	TSW-118-07-G-S	Samtec
2		JP5, JP6	Terminal Strip, 2 position, .100 centers, .025 square pins	TSW-102-07-G-S	Samtec
1		J1	Terminal Strip, 3-Position, Cage Clamp, 45°, Dove-tailed	ED300/3	On-Shore Technology Inc
1		J2	Terminal Strip, 2-Position, Cage Clamp, 45°, Dove-tailed	ED300/2	On-Shore Technology Inc
1		J4	Connector, Modular Receptacle, RJ-45, Side Entry, 8 position/ 8 contact	5520426-4	AMP Tyco Electronics
4		see mechanical drawing/photo/sample board	Standoff, Hex 4-40 Aluminum. 0.500in	2203	Keystone Electronics
4		see mechanical drawing/photo/sample board	Screw, Machine, Phillips, 4-40x1/4 SS	PMSSS 440 0025 PH	Building Fasteners
4		see mechanical drawing/photo/sample board	Shunt, w/ handle, 2 pos, 0.100in	881545-2	Tyco Electronics/AMP

## EVALUATION BOARD/KIT IMPORTANT NOTICE

Texas Instruments (TI) provides the enclosed product(s) under the following conditions:

This evaluation board/kit is intended for use for **ENGINEERING DEVELOPMENT, DEMONSTRATION, OR EVALUATION PURPOSES ONLY** and is not considered by TI to be a finished end-product fit for general consumer use. Persons handling the product(s) must have electronics training and observe good engineering practice standards. As such, the goods being provided are not intended to be complete in terms of required design-, marketing-, and/or manufacturing-related protective considerations, including product safety and environmental measures typically found in end products that incorporate such semiconductor components or circuit boards. This evaluation board/kit does not fall within the scope of the European Union directives regarding electromagnetic compatibility, restricted substances (RoHS), recycling (WEEE), FCC, CE or UL, and therefore may not meet the technical requirements of these directives or other related directives.

Should this evaluation board/kit not meet the specifications indicated in the User's Guide, the board/kit may be returned within 30 days from the date of delivery for a full refund. **THE FOREGOING WARRANTY IS THE EXCLUSIVE WARRANTY MADE BY SELLER TO BUYER AND IS IN LIEU OF ALL OTHER WARRANTIES, EXPRESSED, IMPLIED, OR STATUTORY, INCLUDING ANY WARRANTY OF MERCHANTABILITY OR FITNESS FOR ANY PARTICULAR PURPOSE.**

The user assumes all responsibility and liability for proper and safe handling of the goods. Further, the user indemnifies TI from all claims arising from the handling or use of the goods. Due to the open construction of the product, it is the user's responsibility to take any and all appropriate precautions with regard to electrostatic discharge.

**EXCEPT TO THE EXTENT OF THE INDEMNITY SET FORTH ABOVE, NEITHER PARTY SHALL BE LIABLE TO THE OTHER FOR ANY INDIRECT, SPECIAL, INCIDENTAL, OR CONSEQUENTIAL DAMAGES.**

TI currently deals with a variety of customers for products, and therefore our arrangement with the user **is not exclusive.**

TI assumes **no liability for applications assistance, customer product design, software performance, or infringement of patents or services described herein.**

Please read the User's Guide and, specifically, the Warnings and Restrictions notice in the User's Guide prior to handling the product. This notice contains important safety information about temperatures and voltages. For additional information on TI's environmental and/or safety programs, please contact the TI application engineer or visit [www.ti.com/esh](http://www.ti.com/esh).

No license is granted under any patent right or other intellectual property right of TI covering or relating to any machine, process, or combination in which such TI products or services might be or are used.

### FCC Warning

This evaluation board/kit is intended for use for **ENGINEERING DEVELOPMENT, DEMONSTRATION, OR EVALUATION PURPOSES ONLY** and is not considered by TI to be a finished end-product fit for general consumer use. It generates, uses, and can radiate radio frequency energy and has not been tested for compliance with the limits of computing devices pursuant to part 15 of FCC rules, which are designed to provide reasonable protection against radio frequency interference. Operation of this equipment in other environments may cause interference with radio communications, in which case the user at his own expense will be required to take whatever measures may be required to correct this interference.

### EVM WARNINGS AND RESTRICTIONS

It is important to operate this EVM within the input voltage range of 9V (min) to 20V (max) and the output voltage range of 9V (min) to 20V (max).

Exceeding the specified input range may cause unexpected operation and/or irreversible damage to the EVM. If there are questions concerning the input range, please contact a TI field representative prior to connecting the input power.

Applying loads outside of the specified output range may result in unintended operation and/or possible permanent damage to the EVM. Please consult the EVM User's Guide prior to connecting any load to the EVM output. If there is uncertainty as to the load specification, please contact a TI field representative.

During normal operation, some circuit components may have case temperatures greater than +25°C. The EVM is designed to operate properly with certain components above +25°C as long as the input and output ranges are maintained. These components include but are not limited to linear regulators, switching transistors, pass transistors, and current sense resistors. These types of devices can be identified using the EVM schematic located in the EVM User's Guide. When placing measurement probes near these devices during operation, please be aware that these devices may be very warm to the touch.

Mailing Address: Texas Instruments, Post Office Box 655303, Dallas, Texas 75265  
Copyright 2008, Texas Instruments Incorporated

## IMPORTANT NOTICE

Texas Instruments Incorporated and its subsidiaries (TI) reserve the right to make corrections, modifications, enhancements, improvements, and other changes to its products and services at any time and to discontinue any product or service without notice. Customers should obtain the latest relevant information before placing orders and should verify that such information is current and complete. All products are sold subject to TI's terms and conditions of sale supplied at the time of order acknowledgment.

TI warrants performance of its hardware products to the specifications applicable at the time of sale in accordance with TI's standard warranty. Testing and other quality control techniques are used to the extent TI deems necessary to support this warranty. Except where mandated by government requirements, testing of all parameters of each product is not necessarily performed.

TI assumes no liability for applications assistance or customer product design. Customers are responsible for their products and applications using TI components. To minimize the risks associated with customer products and applications, customers should provide adequate design and operating safeguards.

TI does not warrant or represent that any license, either express or implied, is granted under any TI patent right, copyright, mask work right, or other TI intellectual property right relating to any combination, machine, or process in which TI products or services are used. Information published by TI regarding third-party products or services does not constitute a license from TI to use such products or services or a warranty or endorsement thereof. Use of such information may require a license from a third party under the patents or other intellectual property of the third party, or a license from TI under the patents or other intellectual property of TI.

Reproduction of TI information in TI data books or data sheets is permissible only if reproduction is without alteration and is accompanied by all associated warranties, conditions, limitations, and notices. Reproduction of this information with alteration is an unfair and deceptive business practice. TI is not responsible or liable for such altered documentation. Information of third parties may be subject to additional restrictions.

Resale of TI products or services with statements different from or beyond the parameters stated by TI for that product or service voids all express and any implied warranties for the associated TI product or service and is an unfair and deceptive business practice. TI is not responsible or liable for any such statements.

TI products are not authorized for use in safety-critical applications (such as life support) where a failure of the TI product would reasonably be expected to cause severe personal injury or death, unless officers of the parties have executed an agreement specifically governing such use. Buyers represent that they have all necessary expertise in the safety and regulatory ramifications of their applications, and acknowledge and agree that they are solely responsible for all legal, regulatory and safety-related requirements concerning their products and any use of TI products in such safety-critical applications, notwithstanding any applications-related information or support that may be provided by TI. Further, Buyers must fully indemnify TI and its representatives against any damages arising out of the use of TI products in such safety-critical applications.

TI products are neither designed nor intended for use in military/aerospace applications or environments unless the TI products are specifically designated by TI as military-grade or "enhanced plastic." Only products designated by TI as military-grade meet military specifications. Buyers acknowledge and agree that any such use of TI products which TI has not designated as military-grade is solely at the Buyer's risk, and that they are solely responsible for compliance with all legal and regulatory requirements in connection with such use.

TI products are neither designed nor intended for use in automotive applications or environments unless the specific TI products are designated by TI as compliant with ISO/TS 16949 requirements. Buyers acknowledge and agree that, if they use any non-designated products in automotive applications, TI will not be responsible for any failure to meet such requirements.

Following are URLs where you can obtain information on other Texas Instruments products and application solutions:

### Products

Amplifiers	<a href="http://amplifier.ti.com">amplifier.ti.com</a>
Data Converters	<a href="http://dataconverter.ti.com">dataconverter.ti.com</a>
DSP	<a href="http://dsp.ti.com">dsp.ti.com</a>
Clocks and Timers	<a href="http://www.ti.com/clocks">www.ti.com/clocks</a>
Interface	<a href="http://interface.ti.com">interface.ti.com</a>
Logic	<a href="http://logic.ti.com">logic.ti.com</a>
Power Mgmt	<a href="http://power.ti.com">power.ti.com</a>
Microcontrollers	<a href="http://microcontroller.ti.com">microcontroller.ti.com</a>
RFID	<a href="http://www.ti-rfid.com">www.ti-rfid.com</a>
RF/IF and ZigBee® Solutions	<a href="http://www.ti.com/lprf">www.ti.com/lprf</a>

### Applications

Audio	<a href="http://www.ti.com/audio">www.ti.com/audio</a>
Automotive	<a href="http://www.ti.com/automotive">www.ti.com/automotive</a>
Broadband	<a href="http://www.ti.com/broadband">www.ti.com/broadband</a>
Digital Control	<a href="http://www.ti.com/digitalcontrol">www.ti.com/digitalcontrol</a>
Medical	<a href="http://www.ti.com/medical">www.ti.com/medical</a>
Military	<a href="http://www.ti.com/military">www.ti.com/military</a>
Optical Networking	<a href="http://www.ti.com/opticalnetwork">www.ti.com/opticalnetwork</a>
Security	<a href="http://www.ti.com/security">www.ti.com/security</a>
Telephony	<a href="http://www.ti.com/telephony">www.ti.com/telephony</a>
Video & Imaging	<a href="http://www.ti.com/video">www.ti.com/video</a>
Wireless	<a href="http://www.ti.com/wireless">www.ti.com/wireless</a>

Mailing Address: Texas Instruments, Post Office Box 655303, Dallas, Texas 75265  
Copyright © 2008, Texas Instruments Incorporated