

High Voltage LED Series
Chip on Board

COB R – Series- G2+ Fashion_ Vivid White



High efficacy COB LED package
well-suited for use in spotlight applications



Features & Benefits

- Chip on Board (COB) solution makes it easy to design in
- Simple assembly reduces manufacturing cost
- Low thermal resistance
- InGaN/GaN MQW LED with long time reliability

Applications

- Spotlight / Downlight
- LED Retrofit Bulbs
- Outdoor Illumination

Table of Contents

1.	Characteristics	-----	3
2.	Product Code Information	-----	6
3.	Typical Characteristics Graphs	-----	10
4.	Outline Drawing & Dimension	-----	14
5.	Reliability Test Items & Conditions	-----	17
6.	Label Structure	-----	18
7.	Packing structure	-----	19
8.	Precautions in Handling & Use	-----	22

1. Characteristics

a) Absolute Maximum Rating

Item	Symbol	Model	Rating	Unit	Condition
Ambient / Operating Temperature	T_a	-	-40 ~ +105	°C	-
Storage Temperature	T_{stg}	-	-40 ~ +120	°C	-
LED Junction Temperature	T_J	-	150	°C	-
Case Temperature	T_c	-	115	°C	-
Forward Current / Power Dissipation	I_F / P_D	LC013D	720 / 26.5	mA / W	-
		LC016D	900 / 33.2		-
		LC019D	1080 / 39.8		-
		LC026D	1440 / 53.1		-
		LC033D	1800 / 66.4		-
		LC040D	2160 / 79.7		-
ESD (HBM)	-	-	±2	kV	-

b) Electro-optical Characteristics(I_F = Sorting Current, $T_J = 85\text{ °C}$)

Item	Unit	Model	Rank	Min.	Typ.	Max.
Forward Voltage (V_F)	V		YZ	31.2	34.0	36.9
Color Rendering Index (R_a)	-		7	90	-	-
Thermal Resistance (Junction to CasePoint)	°C/W	LC013D	-	-	0.85	-
		LC016D	-	-	0.67	-
		LC019D	-	-	0.60	-
		LC026D	-	-	0.47	-
		LC033D	-	-	0.4	-
		LC040D	-	-	0.32	-
Beam Angle	°	-	-	-	115	-
Nominal Power / Sorting Current	W (mA)	LC013D	-	-	12.2 / 360	-
		LC016D	-	-	15.3 / 450	-
		LC019D	-	-	18.4 / 540	-
		LC026D	-	-	24.5 / 720	-
		LC033D	-	-	30.6 / 900	-
		LC040D	-	-	36.7 / 1080	-

Notes:

- 1) The COB is tested in pulsed condition at rated test current (10 ms pulse width) and rated temperature ($T_J = T_C = T_a = 85\text{ °C}$)
- 2) Samsung maintains 6 measurement tolerance of: forward voltage = $\pm 5\%$, CRI = ± 1
- 3) Refer to the derating curve, '3. Typical Characteristics Graph' designed within the range.

c) Luminous Flux Characteristics ($I_F = \text{Sorting Current}$)

Model	CRI (R _a) Min.	Nominal CCT (K)	Flux Rank	Flux@ T _c = 85 °C (lm)		
				Min.	Typ.	Max.
LC013D	90	3000	DB	1470	1564	-
		3500	DB	1507	1603	-
		4000	DB	1526	1627	-
LC016D	90	3000	DB	1880	2000	-
		3500	DB	1928	2051	-
		4000	DB	1953	2078	-
LC019D	90	3000	DB	2278	2423	-
		3500	DB	2335	2484	-
		4000	DB	2369	2520	-
LC026D	90	3000	DB	2999	3190	-
		3500	DB	3077	3273	-
		4000	DB	3126	3326	-
LC033D	90	3000	DB	3622	3853	-
		3500	DB	3712	3949	-
		4000	DB	3812	4055	-
LC040D	90	3000	DB	4506	4794	-
		3500	DB	4619	4914	-
		4000	DB	4687	4986	-

Notes:

- 1) The COB is tested in pulsed operating condition at rated test current (10 ms pulse width) and rated temperature ($T_J = T_C = 85 \text{ °C}$).
- 2) Samsung maintains measurement tolerance of: Luminous flux = $\pm 7 \%$, CRI = ± 1

2. Product Code Information

1	2	3	4	5	6	7	8	9	10	11	12	13	14	15	16	17	18
S	P	H	W	H	A	H	D	N	D	2	7	Y	Z	V	N	D	B

Digit	PKG Information	Code	Specification
1 2 3	Samsung Package High Power	SPH	
4 5	Color	WH	White
6	Product Version	A	
7 8	Form Factor	HD	COB
9	Lens Type	N	No lens
10	Wattage or Model	D E F G H K	LC013D LC016D LC019D LC026D LC033D LC040D
11	Internal Code	2	
12	CRI & Sorting Temperature	7	Vivid white, Min. 90 (85°C)
13 14	Forward Voltage (V)	YZ	31.8~37.5
15	CCT (K)	V U T	3000K 3500K 4000K
16	MacAdam Step	M N	Color Bin for Vivid color product(Mac2) Color Bin for Vivid color product(Mac3)
17 18	Luminous Flux (Lm)	DB	COB D-series Gen.2+ level

a) Binning Structure (I_F = Sorting Current, T_J = 85 °C)

Model	CRI (R_a) Min.	Nominal CCT(K)	Product Code	V_f Rank	Color Rank	Flux Rank	Flux Range (Φ_v , lm)
LC013D	90	3000	SPHWHAHNDND27YZVMDB	YZ	VM	DB	1470 ~
			SPHWHAHNDND27YZVNDB		VN		
		3500	SPHWHAHNDND27YZUMDB	YZ	UM	DB	1507 ~
			SPHWHAHNDND27YZUNDB		UN		
		4000	SPHWHAHNDND27YZTMDB	YZ	TM	DB	1529 ~
			SPHWHAHNDND27YZTNDB		TN		
LC016D	90	3000	SPHWHAHNDNE27YZVMDB	YZ	VM	DB	1880 ~
			SPHWHAHNDNE27YZVNDB		VN		
		3500	SPHWHAHNDNE27YZUMDB	YZ	UM	DB	1928 ~
			SPHWHAHNDNE27YZUNDB		UN		
		4000	SPHWHAHNDNE27YZTMDB	YZ	TM	DB	1953 ~
			SPHWHAHNDNE27YZTNDB		TN		
LC019D	90	3000	SPHWHAHDNF27YZVMDB	YZ	VM	DB	2278 ~
			SPHWHAHDNF27YZVNDB		VN		
		3500	SPHWHAHDNF27YZUMDB	YZ	UM	DB	2335 ~
			SPHWHAHDNF27YZUNDB		UN		
		4000	SPHWHAHDNF27YZTMDB	YZ	TM	DB	2369 ~
			SPHWHAHDNF27YZTNDB		TN		
LC026D	90	3000	SPHWHAHDNG27YZVMDB	YZ	VM	DB	2999 ~
			SPHWHAHDNG27YZVNDB		VN		
		3500	SPHWHAHDNG27YZUMDB	YZ	UM	DB	3077 ~
			SPHWHAHDNG27YZUNDB		UN		
		4000	SPHWHAHDNG27YZTMDB	YZ	TM	DB	3126 ~
			SPHWHAHDNG27YZTNDB		TN		

LC033D	90	3000	SPHWAHDNH27YZVMDB	YZ	VM	DB	3622 ~
			SPHWAHDNH27YZVNDB		VN		
		3500	SPHWAHDNH27YZUMDB	YZ	UM	DB	3712 ~
			SPHWAHDNH27YZUNDB		UN		
		4000	SPHWAHDNH27YZTMDB	YZ	TM	DB	3812 ~
			SPHWAHDNH27YZTNDB		TN		
LC040D	90	3000	SPHWAHDNK27YZVMDB	YZ	VM	DB	4506 ~
			SPHWAHDNK27YZVNDB		VN		
		3500	SPHWAHDNK27YZUMDB	YZ	UM	DB	4619 ~
			SPHWAHDNK27YZUNDB		UN		
		4000	SPHWAHDNK27YZTMDB	YZ	TM	DB	4687 ~
			SPHWAHDNK27YZTNDB		TN		

b) Chromaticity Region & Coordinates (I_F = Sorting Current, T_J = 85 °C)

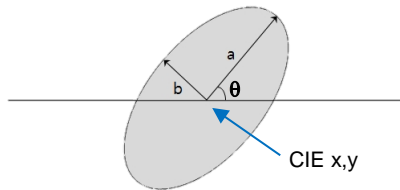
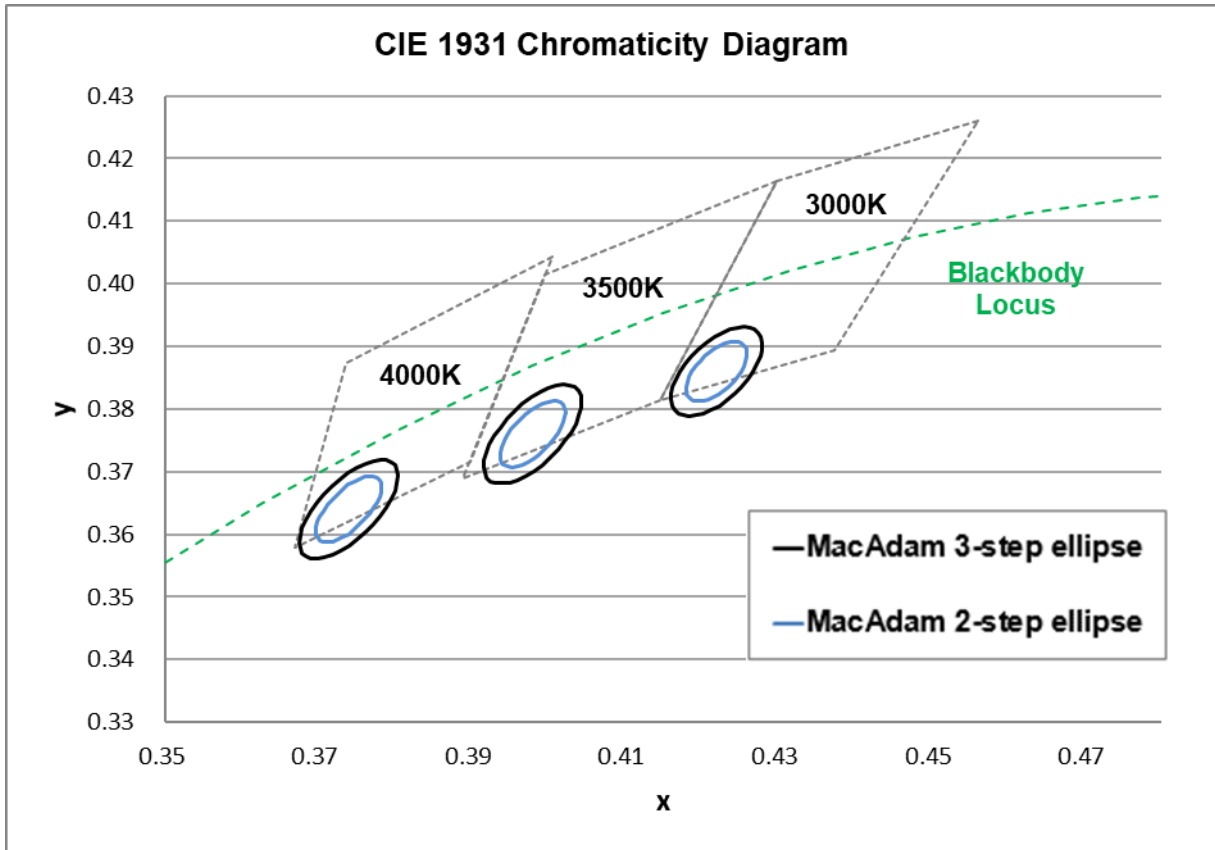

MacAdam Ellipse (VM, VN)					
Step	CIE x	CIE y	θ	a	b
2-step	0.4BB0	0.3860	53.BB	0.0056	0.00B7
3-step	0.4BB0	0.3860	53.BB	0.0083	0.0041

MacAdam Ellipse (UN)					
Step	CIE x	CIE y	θ	a	b
2-step	0.3980	0.3760	54.00	0.006B	0.00B8
3-step	0.3980	0.3760	54.00	0.0093	0.0041

MacAdam Ellipse (TN)					
Step	CIE x	CIE y	θ	a	b
2-step	0.3740	0.3640	53.7B	0.0063	0.00B7
3-step	0.3740	0.3640	53.7B	0.0094	0.0040

3. Typical Characteristics Graphs

a) Spectrum Distribution ($I_F = \text{Sorting Current}$, $T_J = 85\text{ }^\circ\text{C}$)

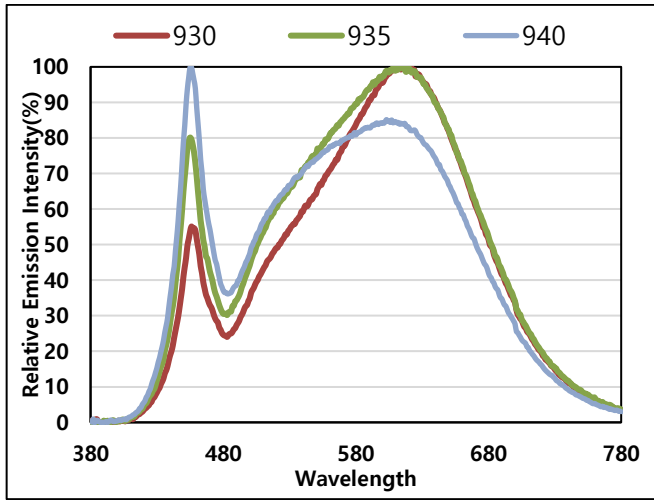

b) Forward Current Characteristics ($T_J = 85\text{ }^\circ\text{C}$)

LC013D

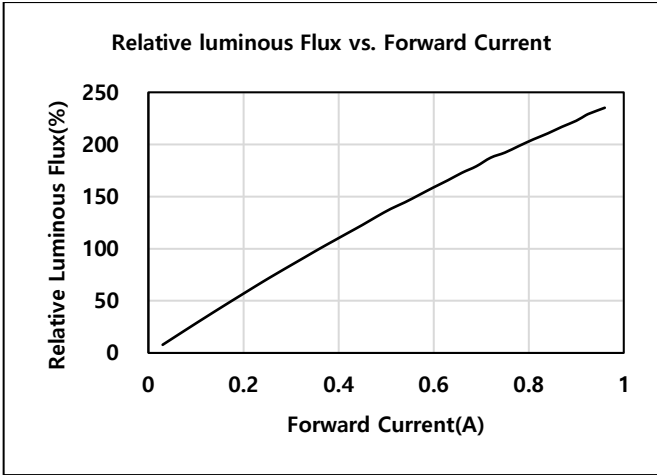

LC016D

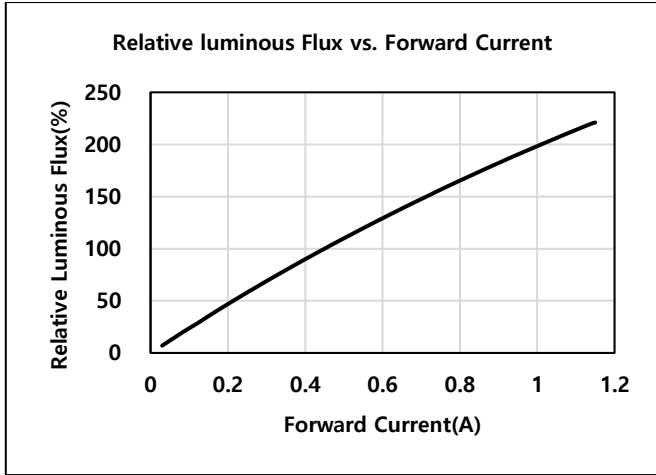

LC019D

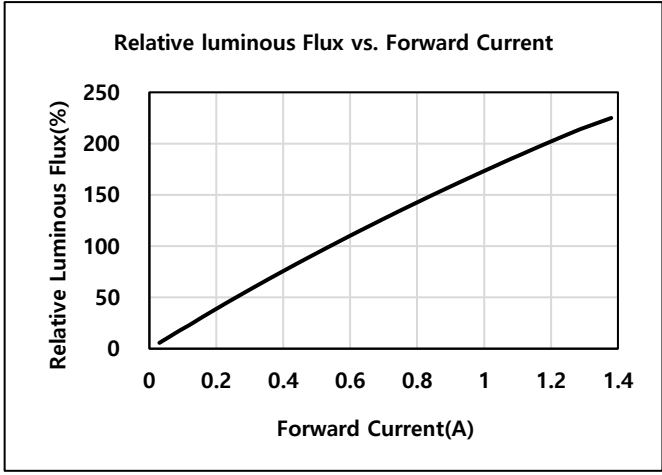

LC026D

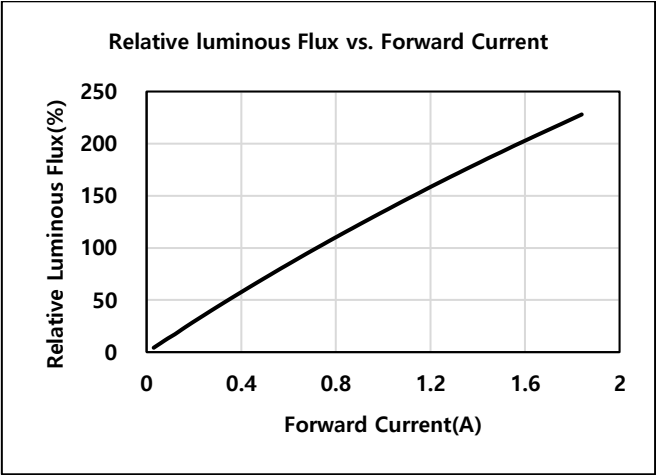

LC033D

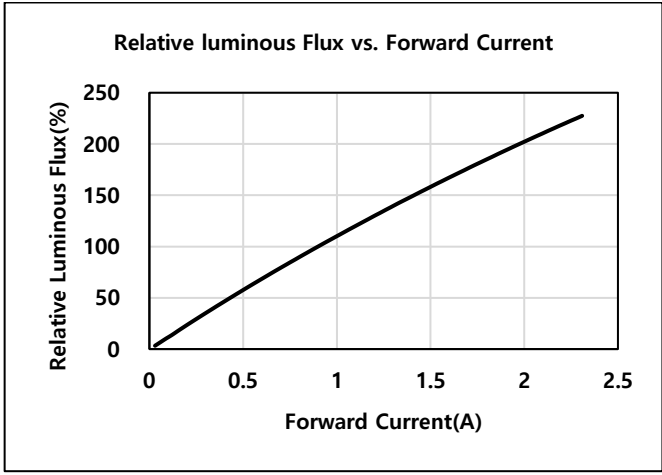

LC040D

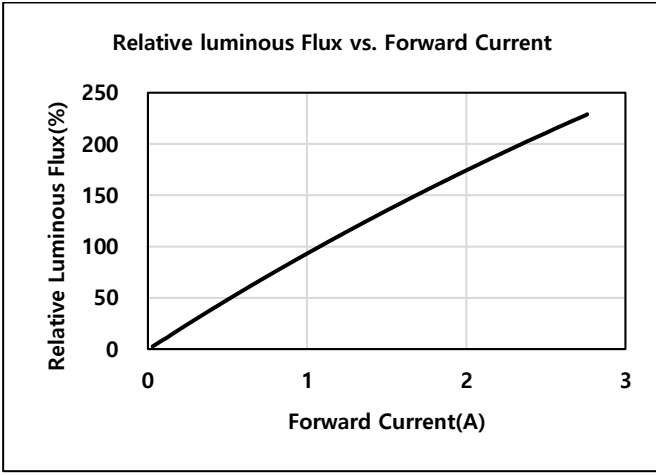

c) Temperature Characteristics (I_f = Sorting Current)

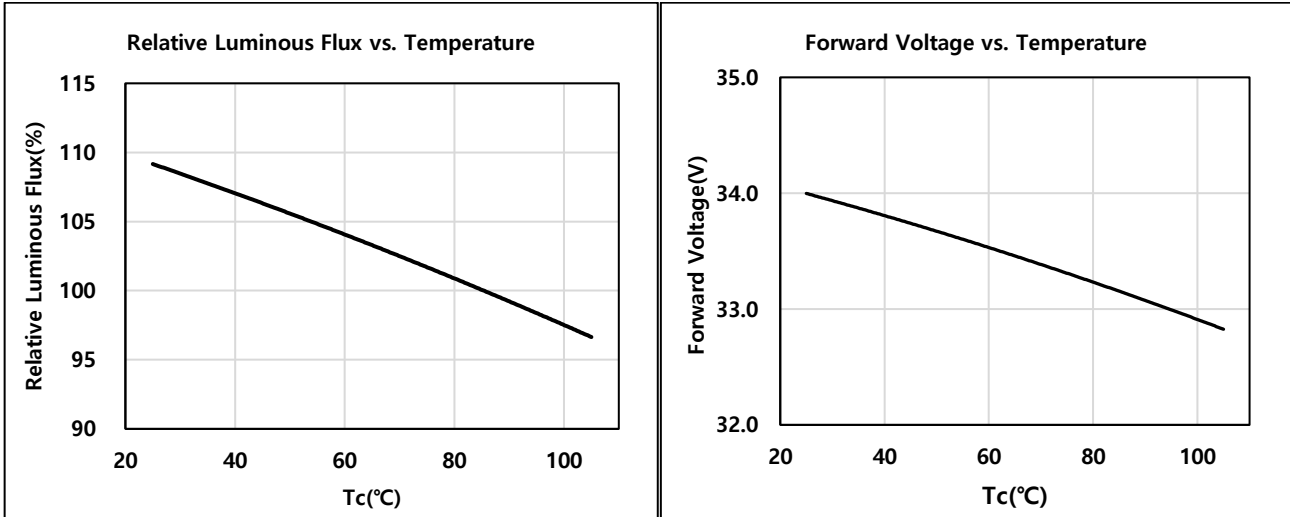

d) Color Shift Characteristics ($T_J = 85\text{ }^\circ\text{C}$, I_f = Sorting Current)

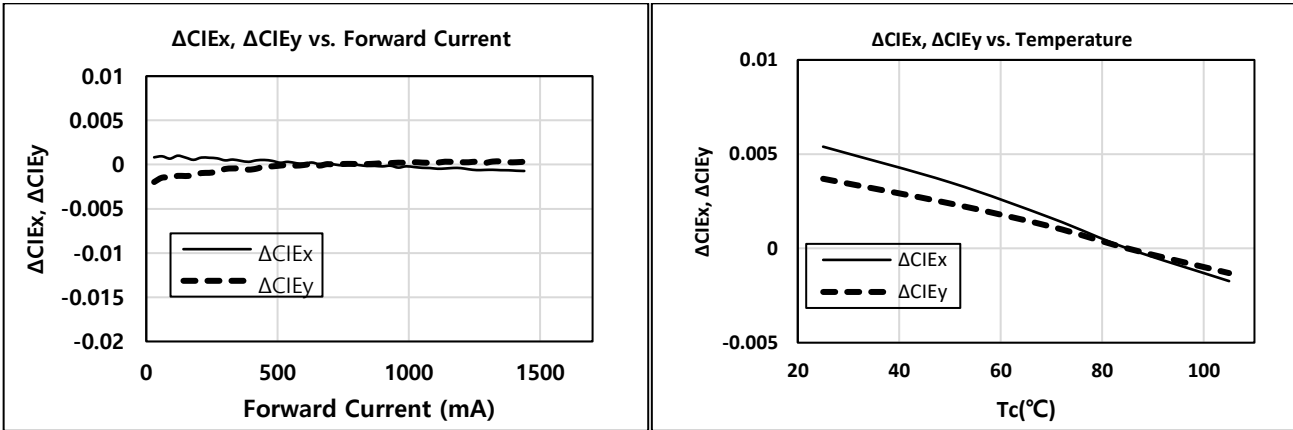

e) Beam Angle Characteristics (I_f = Sorting Current, $T_J = 85\text{ }^\circ\text{C}$)

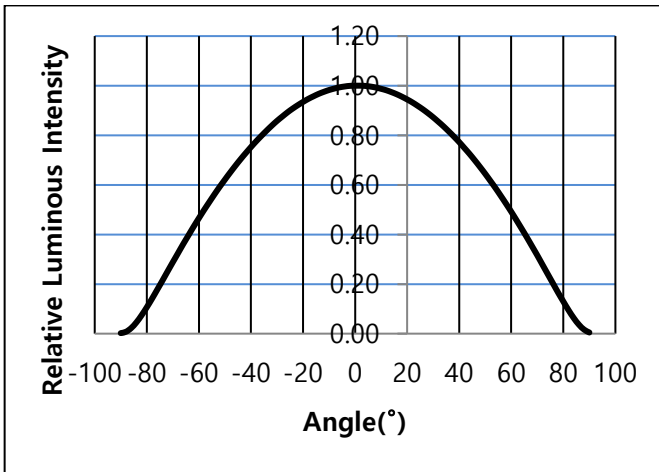

f) Derating Characteristics

LC013D

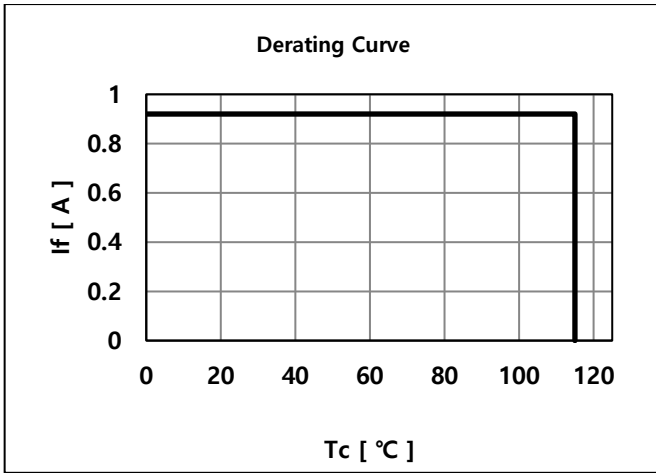

LC016D

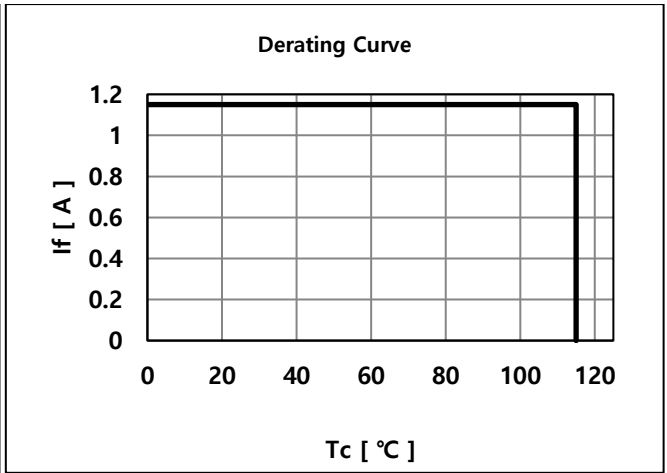

LC019D

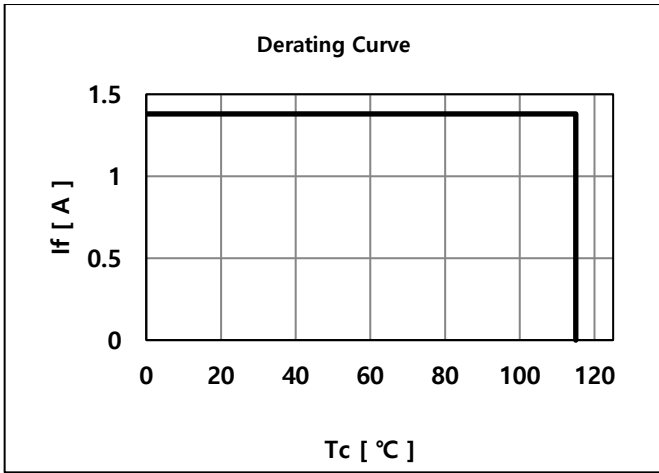

LC0B6D

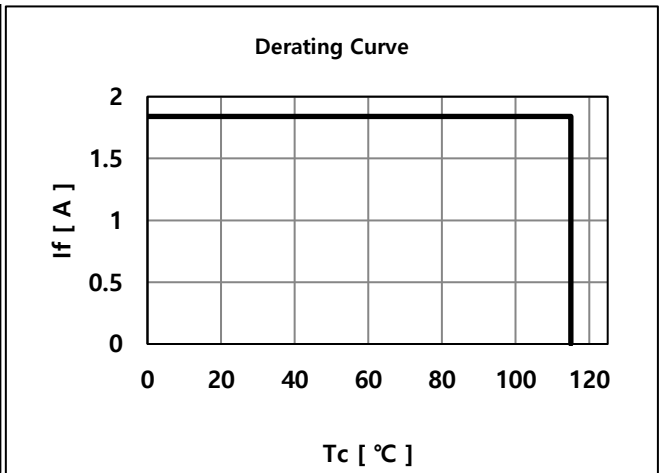

LC033D

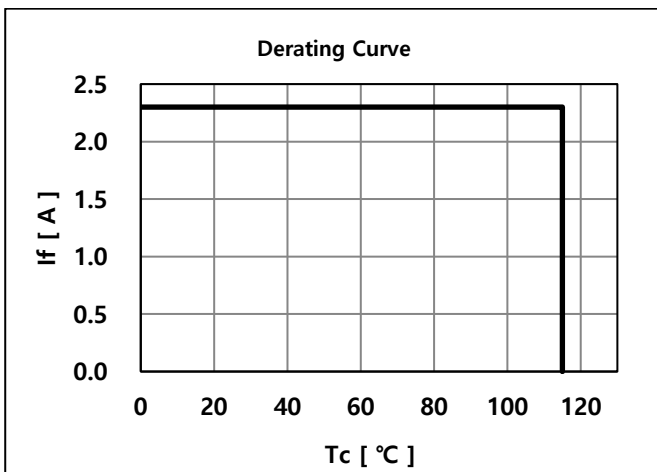

LC040D

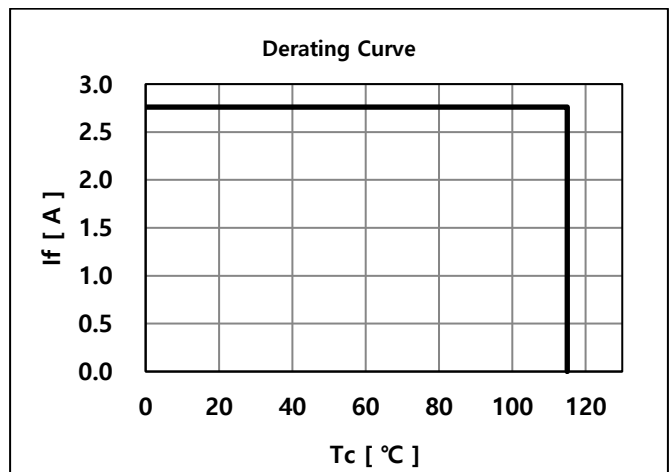

4. Outline Drawing & Dimension

※ Model : LC013D

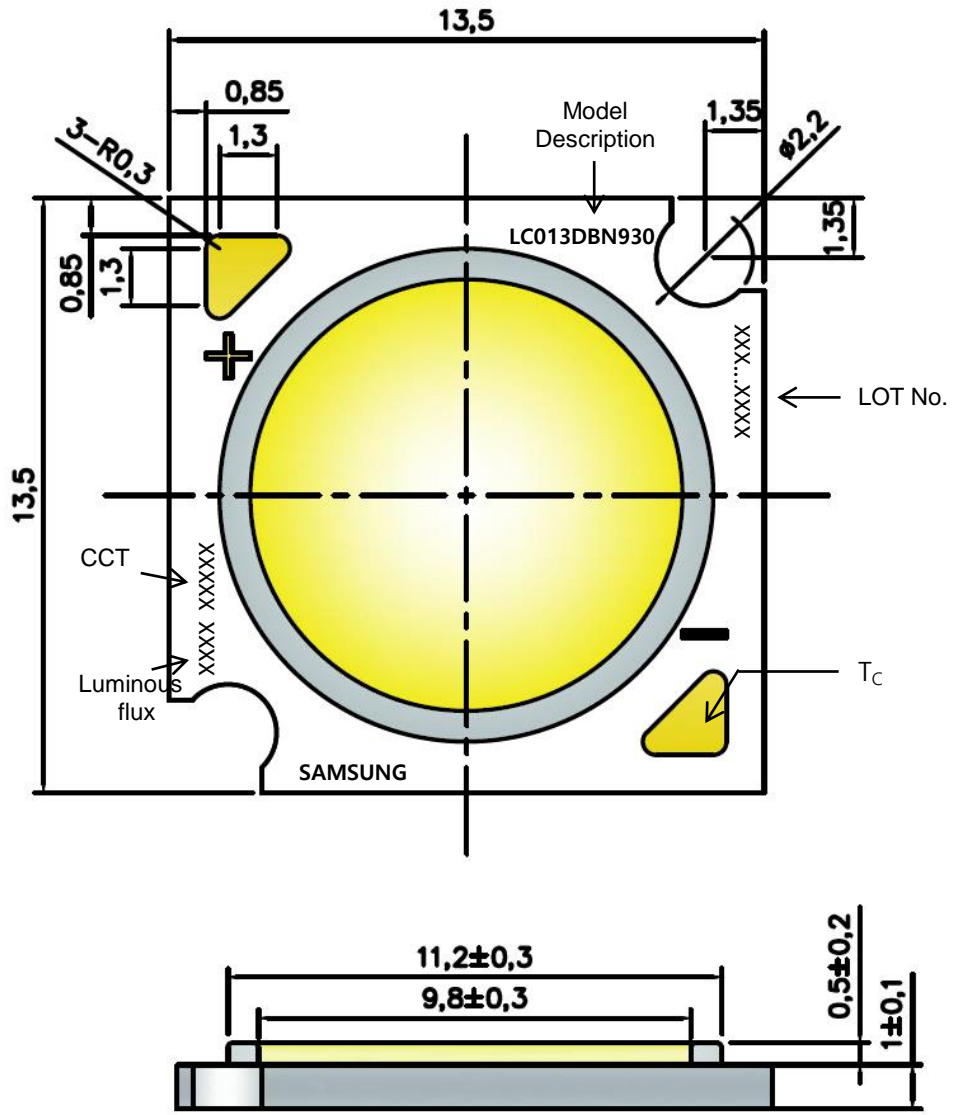

1. Unit: mm
2. Tolerance: ± 0.3 mm

Item	Dimension	Tolerance	Unit
Length	13.5	±0.20	mm
Width	13.5	±0.20	mm
Height	Dam	0.5	±0.20 mm
	Substrate	1	±0.10 mm
	From the bottom of the substrate to the LES	2	Max mm
LES Diameter	Light Emitting Surface	9.8	±0.30 mm

Note: Denoted product information above is only an example
(LC013DBN930 : LC013DB, Gen2+, Ra90, 3000K)

※ Model : LC016D, LC019D, LC026D, LC033D

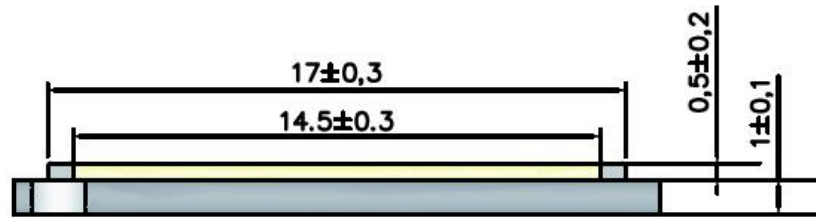
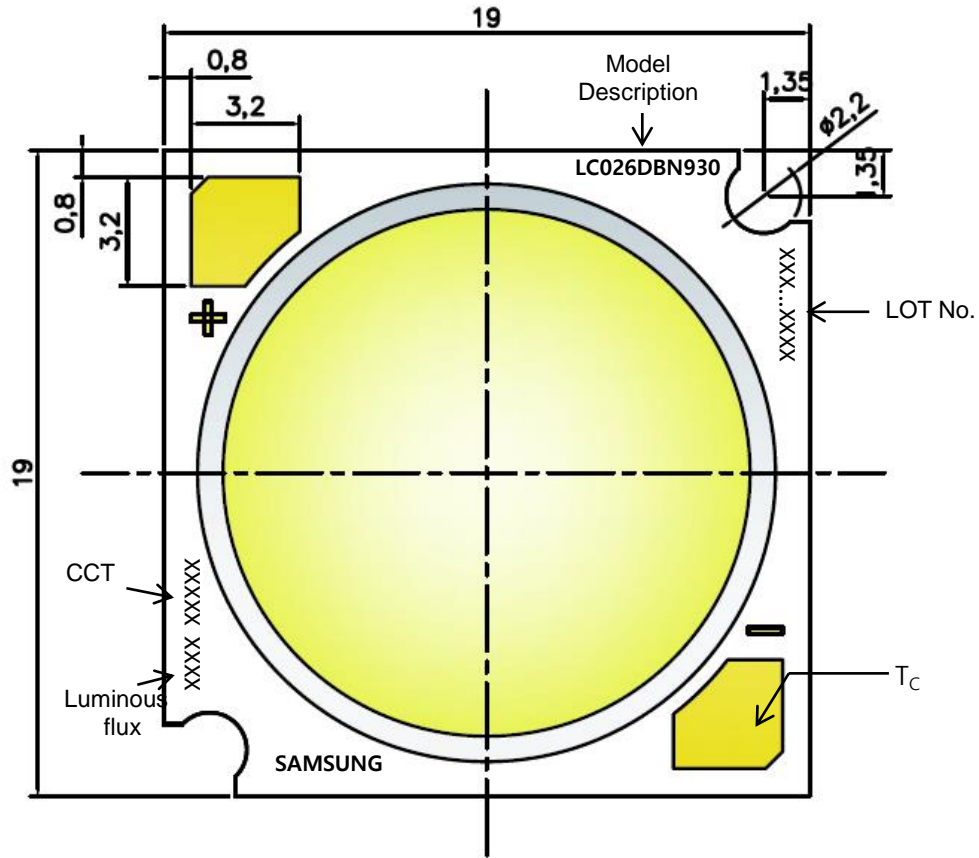

- 1. Unit: mm
- 2. Tolerance: ± 0.3 mm

Item	Dimension	Tolerance	Unit
Length	19.0	±0.20	mm
Width	19.0	±0.20	mm
Height	Dam	±0.20	mm
	Substrate	±0.10	mm
	From the bottom of the substrate to the LES	Max	mm
LES Diameter	Light Emitting Surface	±0.30	mm

Note: Denoted product information above is only an example
(LC026DBN930 : LC026DB, Gen2+, CRI90+, 3000K)

※ Model : LC040D

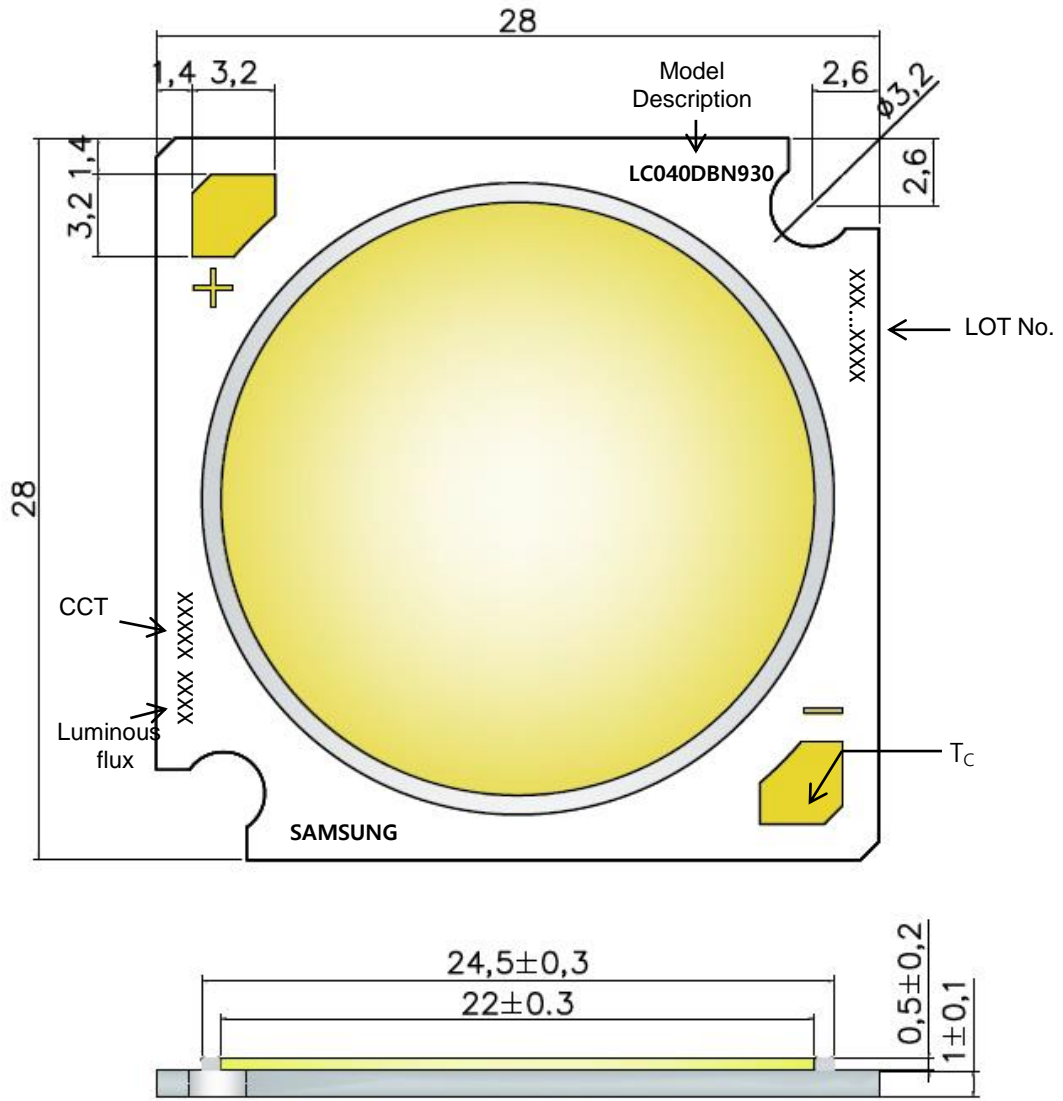

- 1. Unit: mm
- 2. Tolerance: ± 0.3 mm

Item	Dimension	Tolerance	Unit
Length	28.0	±0.20	mm
Width	28.0	±0.20	mm
Height	Dam	0.5	±0.20 mm
	Substrate	1.0	±0.10 mm
	From the bottom of the substrate to the LES	2.0	Max mm
LES Diameter	Light Emitting Surface	22.0	±0.30 mm

Note: Denoted product information above is only an example
 (LC040DBN930 : LC040D, Gen2+, CR190+, 3000K)

5. Reliability Test Items & Conditions

a) Test Items

Test Item	Test Condition	Test Hour / Cycle
High Temperature Humidity Life Test	60 °C, 90 % RH,, DC Derating, I_F	1000 h
High Temperature Life Test	85 °C, DC Derating, I_F	1000 h
Low Temperature Life Test	-40 °C, DC, Derating I_F	1000 h
High Temperature Storage	120 °C	1000 h
Low Temperature Storage	-40 °C	1000 h
Temperature Humidity Storage	60 °C, 90% RH	1000h
Temperature Cycle On/Off Test	-40 °C/ 85 °C each 20 min, 30 min transfer power on/off each 5 min, DC Derating, $I_F = \text{max}$	100 cycles
ESD (HBM)	R ₁ : 10 MΩ R ₂ : 1.5 kΩ C: 100 pF V: ±2 kV	5 times
Vibration Test	20~ 80 Hz (displacement: 0.06 inch, max. 20 g) 80 ~ 2 kHz (max. 20 g) min. frequency ↔ max. frequency 4 min transfer	4 times
Mechanical Shock Test	1500g, 0.5 ms each of the 6 surfaces (3 axis x 2 sides)	5 times
Sulfur Resistance	25 °C, 75%, H ₂ S 15 ppm	504h

b) Criteria for Judging the Damage

Item	Symbol	Test Condition ($T_c = 25\text{ °C}$)	Limit	
			Min.	Max.
Forward Voltage	V_F	$I_F = \text{Sorting Current}$	L.S.L. * 0.9	U.S.L. * 1.1
Luminous Flux	Φ_v	$I_F = \text{Sorting Current}$	L.S.L * 0.7	U.S.L * 1.3

6. Label Structure

a) Label Structure

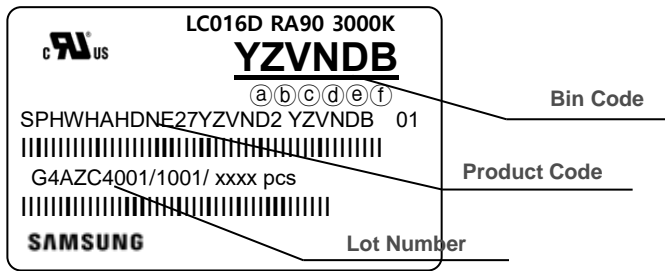

Note: Denoted bincode and product code above is only an example (see description on page 5)

Bin Code:

- ⒶⒷ: Forward Voltagebin (refer to page11)
- ⒸⒹ: Chromaticitybin (refer to page 9-10)
- ⒺⒻ: Luminous Fluxbin (refer to page 6)

b) Lot Number

The lot number is composed of the following characters:

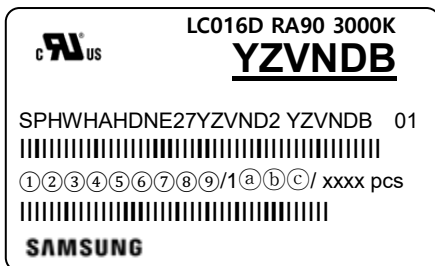

① ③④⑤⑥⑦⑧⑨ / 1ⒶⒷⒸ / xxxx pcs

- ① : Production site (S: Giheung, Korea, G: Tianjin, China)
- ② : 4(LED)
- ③ : Product state (A: Normal, B: Bulk, C: First Production, R: Reproduction, S: Sample)
- ④ : Year (Z: B015, A: B016, B: B017...)
- ⑤ : Month (1~9, A, B, C)
- ⑥⑦⑧⑨ : Day (1~9, A, B~V)
- ⒶⒷⒸ : Product serial number (001 ~ 999)

7. Packing Structure

※ LC013D

Packing material	Max. quantity in pcs of COB	Dimension(mm)			
		Length	Width	Height	Tolerance
Tray	50	200	200	8	1
Anti-Static Bag	250 (5 trays)	320	270	-	+/- 0.5
Outer Box (Small)	500 (2 bags)	225	225	65	5
Outer Box (Middle)	1000 (4 bags)	225	225	130	5

a) Packing Structure

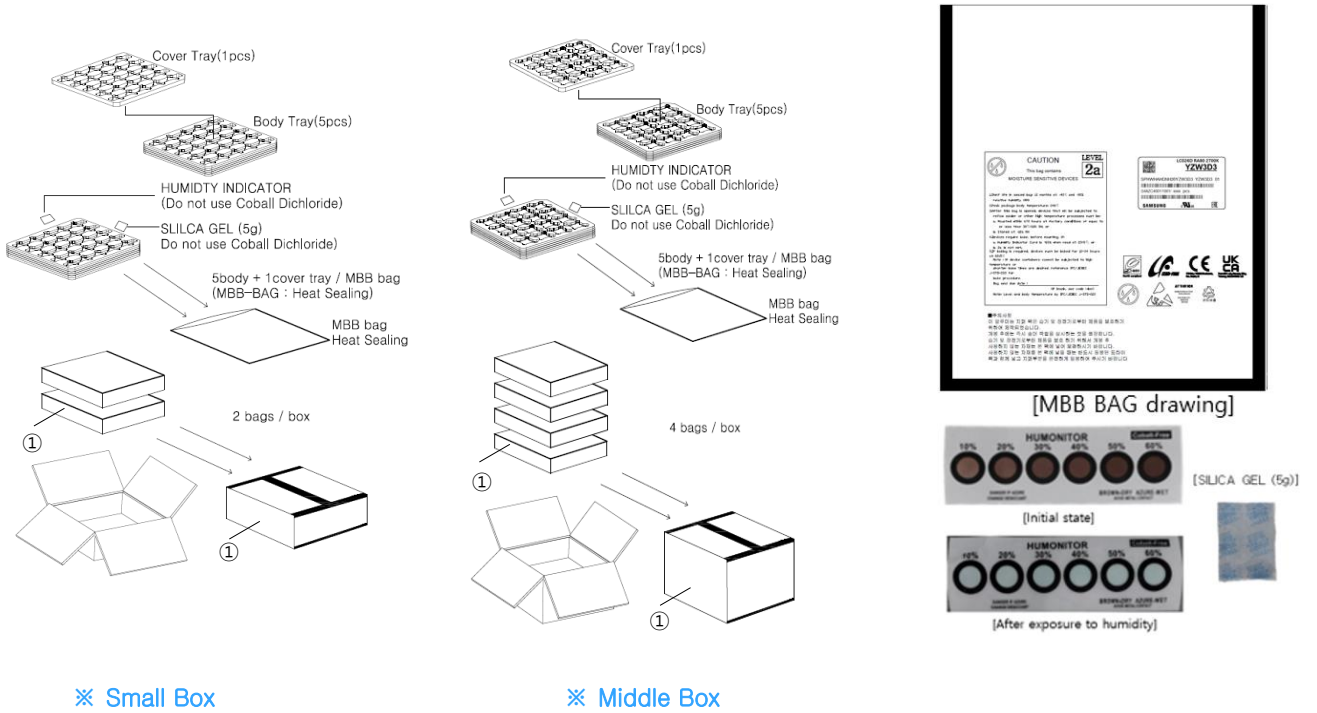

※ Small Box

※ Middle Box

b) Tray

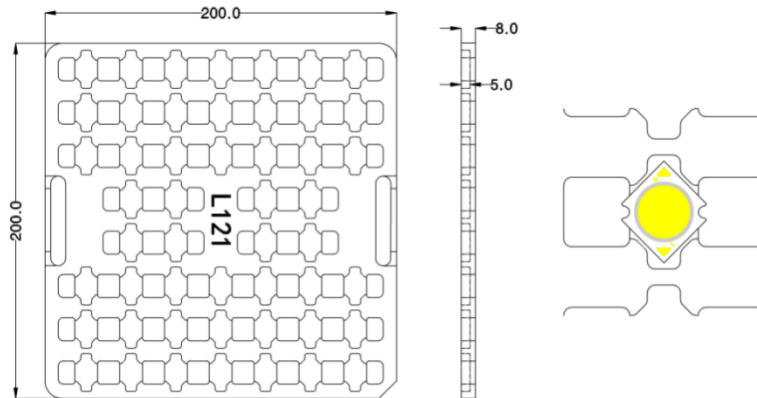

※ LC016D, LC0B6D, LC033D

Packing material	Max. quantity in pcs of COB	Dimension(mm)			
		Length	Width	Height	Tolerance
Tray	25	200	200	8	1
Anti-Static Bag	125 (5 trays)	320	270	-	+/- 0.5
Outer Box (Small)	250 (2 bags)	225	225	65	5
Outer Box (Middle)	500 (4 bags)	225	225	130	5

a) Packing Structure

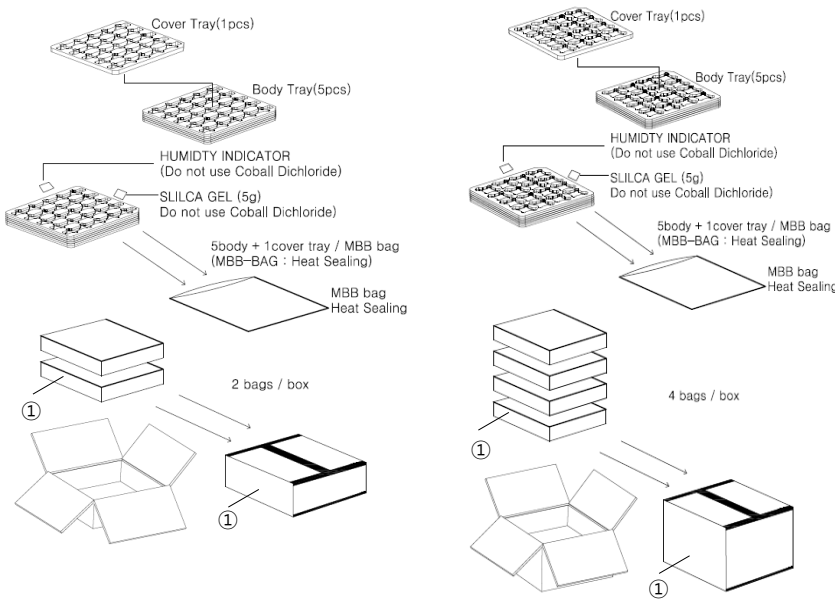

※ Small Box

※ Middle Box



[MBB BAG drawing]

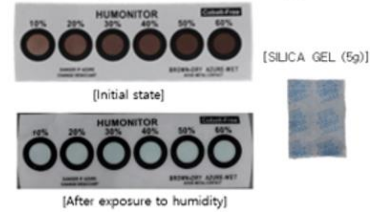

b) Tray

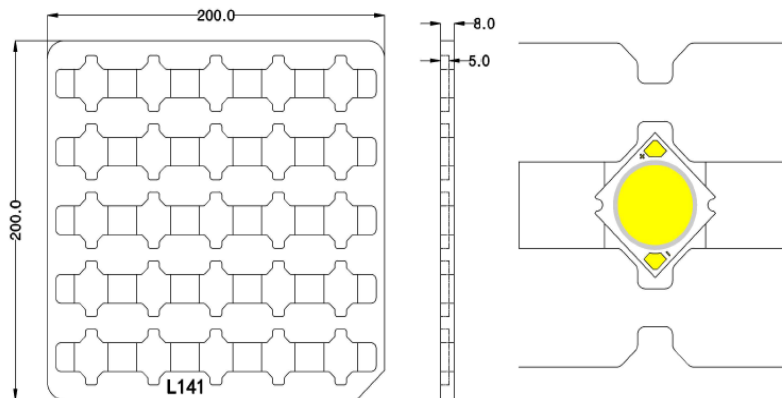

※ LC040D

Packing material	Max. quantity in pcs of COB	Dimension(mm)			
		Length	Width	Height	Tolerance
Tray	16	200	200	8	1
Anti-Static Bag	80 (5 trays)	320	270	-	+/- 0.5
Outer Box (Small)	160 (2 bags)	225	225	65	5
Outer Box (Middle)	320 (4 bags)	225	225	130	5

a) Packing Structure

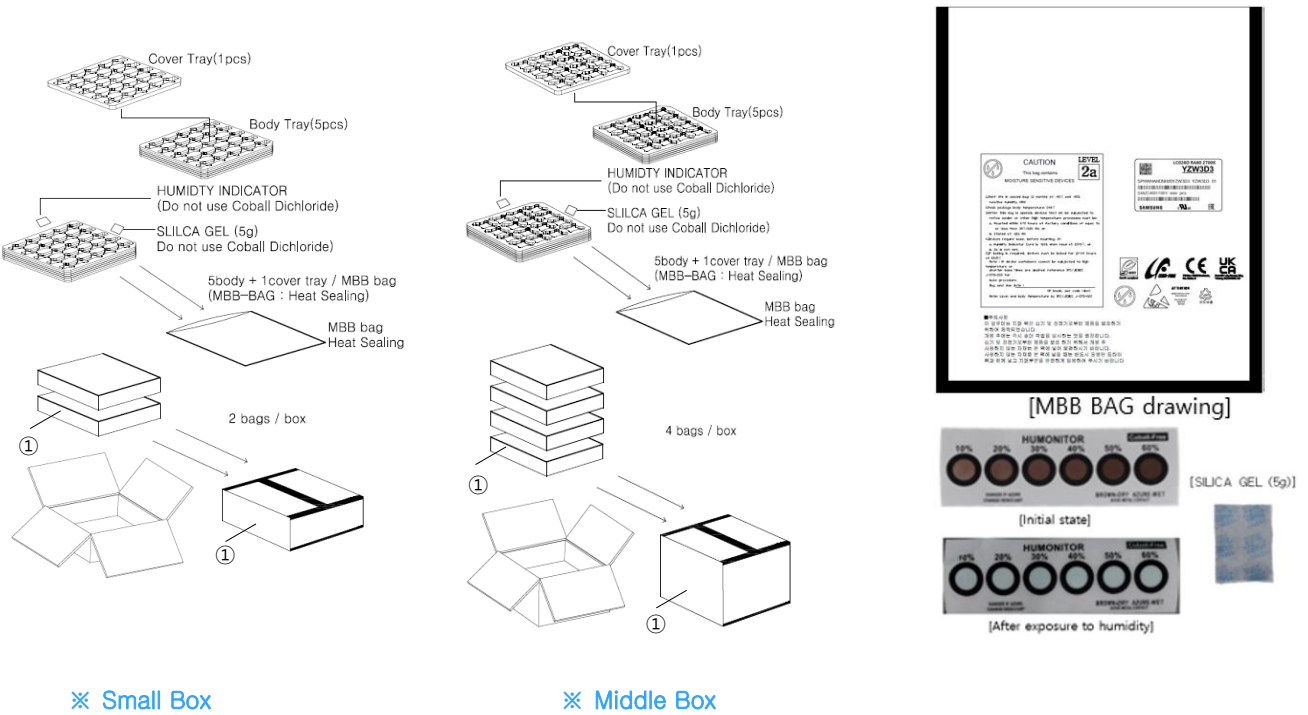

※ Small Box

※ Middle Box

b) Tray

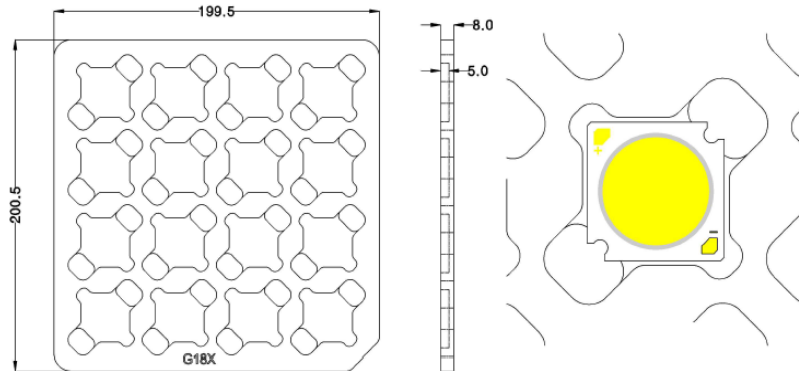

8. Precautions in Handling & Use

- 1) This device should not be used in any type of fluid such as water, oil, organic solvent, etc. When cleaning is required, IPA is recommended as the cleaning agent. Some solvent-based cleaning agent may damage the silicone resins used in the device.
- 2) LEDs must be stored in a clean environment. If the LEDs are to be stored for three months or more after being shipped from Samsung, they should be packed with a nitrogen-filled container (shelf life of sealed bags is 12 months at temperature 0~40 °C, 0~90 % RH).
- 3) After storage bag is opened, device subjected to soldering, solder reflow, or other high temperature processes must be:
 - a. Mounted within 672 hours (28 days) at an assembly line with a condition of no more than 30 °C / 60 % RH, or
 - b. Stored at <10 % RH
- 4) Repack unused products with anti-moisture packing, fold to close any opening and then store in a dry place.
- 5) Devices require baking before mounting, if humidity card reading is >60 % at 23 ± 5 °C.
- 6) Devices must be baked for 1 hour at 60 ± 5 °C, if baking is required.
- 7) The LEDs are sensitive to the static electricity and surge current. It is recommended to use a wrist band or anti-electrostatic glove when handling the LEDs. If voltage exceeding the absolute maximum rating is applied to LEDs, it may cause damage or even destruction to LED devices. Damaged LEDs may show some unusual characteristics such as increase in leakage current, lowered turn-on voltage, or abnormal lighting of LEDs at low current.
- 8) The thermal management is one of the most critical factors for the LED lighting system. Especially the LED junction temperature should not exceed the absolute maximum rating while operation of LED lighting system.
For more information, please refer to Application Note 'Mechanical & Thermal Guide for COB'.
- 9) In case of driving LEDs around the minimum current level (I_{f_min}), chips might exhibit different brightness due to the variation in I-V characteristics of each one. This is normal and does not adversely affect the performance of product.
- 10) VOCs (Volatile Organic Compounds) can be generated from adhesives, flux, hardener or organic additives used in luminaires (fixtures). Transparent LED silicone encapsulant is permeable to those chemicals and they may lead to a discoloration of encapsulant when they exposed to heat or light. This phenomenon can cause a significant loss of light emitted (output) from the luminaires. In order to prevent these problems, we recommend users to know the physical properties of materials used in luminaires and they must be carefully selected.
- 11) The resin area is very sensitive, please do not handle, press, touch, rub, clean, or pick by with tweezers on it. Instead, please pick at the handling area as indicated below.

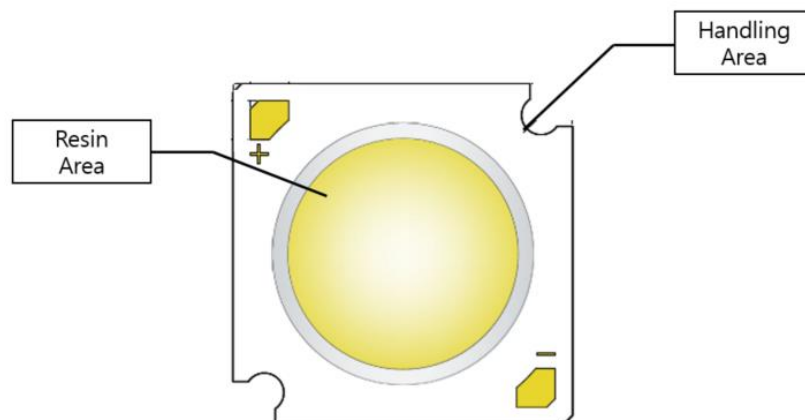

Legal and additional information.

[About Samsung Electronics Co., Ltd.](#)

Samsung Electronics Co., Ltd. inspires the world and shapes the future with transformative ideas and technologies, redefining the worlds of TVs, smartphones, wearable devices, tablets, cameras, digital appliances, printers, medical equipment, network systems and semiconductors.

We are also leading in the Internet of Things space through, among others, our Digital Health and Smart Home initiatives. We employ 307,000 people across 84 countries. To discover more, please visit our official website at www.samsung.com and our official blog at global.samsungtomorrow.com.

Samsung provides limited warranty for its LED products, the full text of which is available at <https://www.samsung.com/led/support/warranties>.

Copyright © B015 Samsung Electronics Co., Ltd. All rights reserved.
Samsung is a registered trademark of Samsung Electronics Co., Ltd.
Specifications and designs are subject to change without notice. Non-metric weights and measurements are approximate. All data were deemed correct at time of creation. Samsung is not liable for errors or omissions. All brand, product, service names and logos are trademarks and/or registered trademarks of their respective owners and are hereby recognized and acknowledged.

Samsung Electronics Co., Ltd.
95, Samsung B-ro
Giheung-gu
Yongin-si, Gyeonggi-do, 446-711
KOREA

www.samsung.com/led