



CoolGaN™ – the new power paradigm

Ultimate efficiency and reliability

EN

www.infineon.com/gan





Wide bandgap semiconductors

A new era in power electronics

From operating expense and capital expenditure reduction, through higher power density enabling smaller and lighter designs, to overall system cost reduction, the benefits are compelling.



Interested? Learn more at:
www.infineon.com/wbg

Content

CoolGaN™ e-mode HEMTs	4
Driving CoolGaN™ e-mode HEMTs	7
CoolGaN™ in the applications:	
Server	8
Telecom	10
Wireless charging	12
Adapter and charger	15
Class D audio	16
CoolGaN™ evaluation environment	18
CoolGaN™ product portfolio	19
CoolGaN™ nomenclature	20
Support	24

Gallium nitride (GaN)

Mastering power technologies of tomorrow

The continuous growth of the world's population and the acceleration of social development have led to an increasing demand for electricity. The increasingly urgent environmental pressure has forced us to do more with less energy.

The key for the next essential step towards an energy-efficient world lies in the use of new materials, like wide bandgap semiconductors which are allowing for greater power efficiency, smaller size, lighter weight, lower cost – or all of these together. Infineon Technologies with its unique position of being the only company currently offering Si, SiC, IGBT and GaN devices is the customer's first choice in all segments.

Why CoolGaN™

Compared to silicon (Si), the breakdown field of Infineon's CoolGaN™ enhancement mode (e-mode) HEMTs is ten times higher and the electron mobility is double. Both the output charge and gate charge are ten times lower than with Si and the reverse recovery charge is almost zero which is key for high frequency operations. GaN is the suitable technology of choice in hard switching as well as resonant topologies, and is enabling new approaches in current modulation. Infineon's GaN solution is based on the most robust and performing concept in the market – the enhancement mode concept offering fast turn-on and turn-off speed. CoolGaN™ products focus on high performance and robustness, and add significant value to a broad variety of systems across many applications such as server, telecom, wireless charging, adapter and charger, and audio.

Comparison of key figures of merit (FOM) for Si, GaN and SiC devices

CoolGaN™ sets the performance benchmark among currently available 600 V devices.

Device	Vendor	$R_{DS(on)}$ [typ mΩ]	$R_{DS(on)} * Q_{oss}$ [mΩ * μC]	$R_{DS(on)} * Q_{RR}$ [mΩ * μC]	$R_{DS(on)} * E_{oss}$ [mΩ * μJ]	$R_{DS(on)} * Q_G$ [mΩ * nC]	Structure
CoolMOS™ C7 600 V	Infineon	57	22.6	32.5	440	3820	Vertical
CoolGaN™ 600 V	Infineon	55	2.2 ¹⁾	0 ²⁾	350 ³⁾	320 ⁴⁾	Lateral
GaN e-mode 650 V	Competitor A	50	2.8	0	350	290	Lateral
GaN Cascode 600 V	Competitor B	52	3.8	7.0	730	1460	Lateral 2 chips
GaN D-Drive 600 V	Competitor C	70	4.1	0	530	-	Lateral 2 chips
SiC DMOS 900 V	Competitor D	65	4.5	4.0	570	1950	Vertical
SiC TMOS 650 V	Competitor E	60	3.8	3.3	540	3480	Vertical

All values given typical at 25°C incl. package. Q_{RR} is exclusive of Q_{oss} .

¹⁾ Facilitates dead time setting and enables high frequency designs > 400 kHz

²⁾ Switch can be operated as fast switching diode which enables use in totem pole PFC

³⁾ Low losses in hard switching topologies

⁴⁾ Low driving losses: benefit especially in light load efficiency

Features

- > Low output charge and gate charge
- > No reverse recovery charge

Design benefits

- > High power density, small and light design
- > High efficiency in resonant circuits
- > New topologies and current modulation
- > Fast and (near-) lossless switching

Advantages

- > Operational expenses (OPEX) and capital expenditure (CAPEX) reduction
- > BOM and overall cost savings

The normally-off concept

The technology for innovative solutions and high volumes

GaN devices are by nature normally-on devices, since the 2DEG channel is immediately present in an GaN/AlGaN heterojunction. Power electronics industry, however, strongly wishes normally-off devices. There are two ways to achieve that: the so-called Cascode approach or to realize a real monolithic enhancement mode device. Infineon is focusing on the e-mode GaN concept for its CoolGaNTM 400 V and 600 V devices, suitable for all consumer and industrial applications with the most robust and performing concept in the market.

Hybrid drain-GIT, normally-off GaN

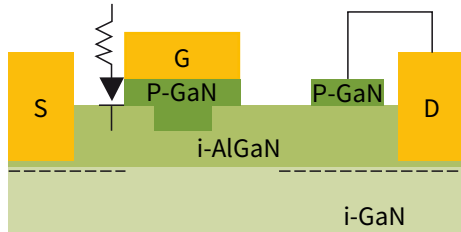

Enhancement mode GaN (normally-off)

- > Excellent for hard and soft switching topologies
- > Turn-on and turn-off optimized
- > $R_{DS(on)}$ shift immunity
- > Excellent V_{th} stability
- > Best FOMs
- > Longer lifetime proven

GaN enables simpler and more efficient half-bridge topologies such as totem pole

Nowadays, several high efficiency topologies for CCM PFC are available like interleaved stages or dual boost. The BOM costs and part count depend on efficiency targets. CoolGaNTM technology enables to use these simpler and cost effective half-bridge/hard switching topologies and at the same time to achieve higher efficiency. With almost zero reverse recovery charge (Q_{rr}) CoolGaNTM allows for simpler, highly efficient, and cost effective system solutions in half-bridge totem pole or full-bridge totem pole topologies.

Half-bridge totem pole

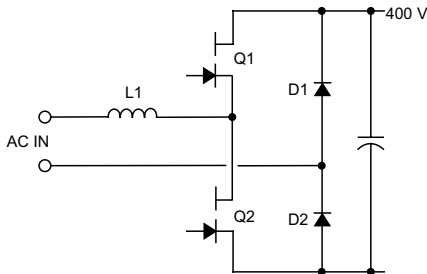

Full-bridge totem pole

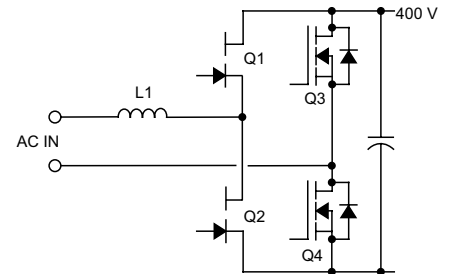

← GaN has zero Q_{rr} →

GaN enables highest efficiency and power density

In the evaluation of Infineon's 2.5 kW PFC FB totem pole board (EVAL_2500W_PFC_GAN_A), CoolGaNTM demonstrates its unique benefits in hard switching topologies showing a flat efficiency of >99% over a wide load range. The use of simplified topologies and the benefits of GaN switching performance additionally allows potential system cost reduction.

**2.5 kW totem pole PFC board:
EVAL_2500W_PFC_GAN_A**



- > 2 x 70 mΩ CoolGaNTM in DSO-20-85
- > 2 x 33 mΩ CoolMOS™

2.5 kW totem pole PFC, efficiency vs. load ($f_{sw} = 65$ kHz)

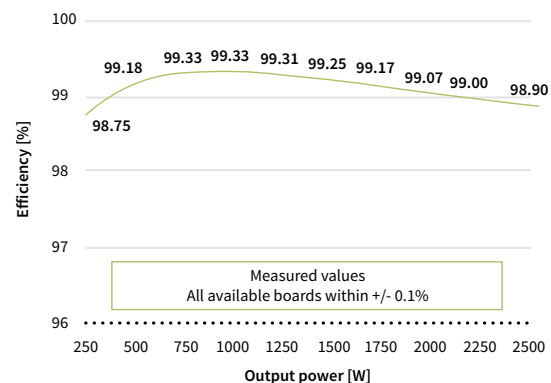

CoolGaN™ enables higher power density at the same efficiency

The reduced switching losses - associated with GaN - deliver smaller and lighter designs. On one hand, the SMD packaged device allows compact and modular designs, while on the other hand, smaller heatsinks and less components can be used. Additionally, moving to higher switching frequency in certain applications (when required) reduces the size of the passives. At system level, higher power density achieved by GaN-based power supplies allows more computing power to be installed within the same volume.

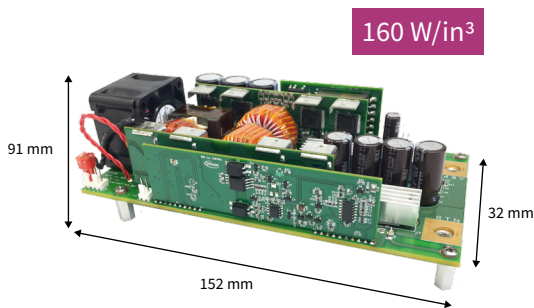

3.6 kW LLC, f_{sw} 350 kHz, 380 V-54 V, using IGT60R070D1

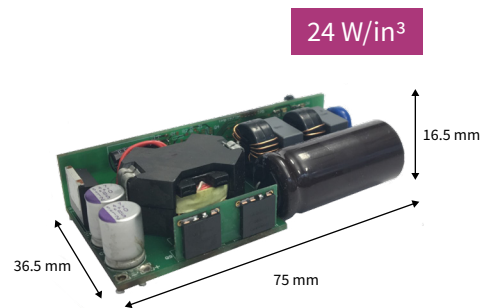

65 W hybrid flyback, f_{sw} 72 to 196 kHz, V_{in} 90 to 264 V_{rms}, V_{out} 3 to 20 V, using IGLD60R190D1

Qualification that exceeds industry standards

Infineon's CoolGaN™ is one of the most reliable globally qualified GaN solution in the market. During the quality management process not only the device is tested, but also its behavior in the application. The performance of CoolGaN™ goes beyond other GaN products in the market. It offers a predicted lifetime of more than 15 years, with a failure rate less than 1 FIT.

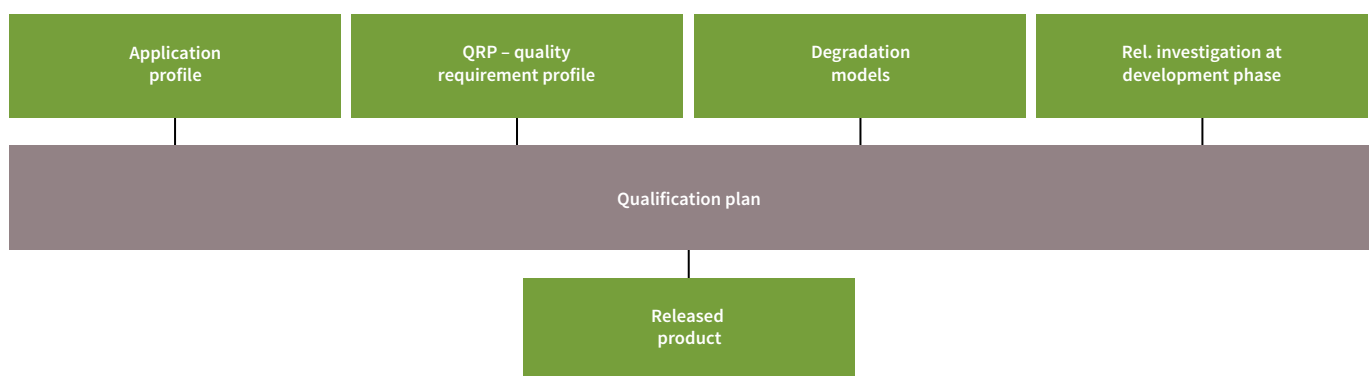

Infineon's CoolGaN™ 400 V and 600 V e-mode HEMTs target consumer and industrial applications such as server, telecom, charger and adapter, wireless charging and audio.

GaN EiceDRIVER™ family

Single-channel isolated gate-driver ICs for enhancement mode GaN HEMTs

Infineon's CoolGaN™ 400 V and 600 V e-mode HEMTs enable 98% + system efficiency and help customers to make their end products smaller and lighter. Driving enhancement mode devices requires some additional features when choosing the correct gate driver IC; however, CoolGaN™ technology does not require customized ICs. Infineon introduces three new members of its single-channel galvanically isolated gate driver IC family. The new components are a perfect fit for enhancement mode GaN HEMTs with non-isolated gate (diode input characteristic) and low threshold voltage, such as CoolGaN™.

Complete support for all requirements specific to e-mode GaN HEMTs operation:

- › Low driving impedance (on-resistance 0.85 Ω source, 0.35 Ω sink)
- › Resistor programmable gate current for steady on-state (typical 10 mA)
- › Programmable negative gate voltage to completely avoid spurious turn-on in half-bridges

Block diagram: typical application example – totem pole full-bridge PFC

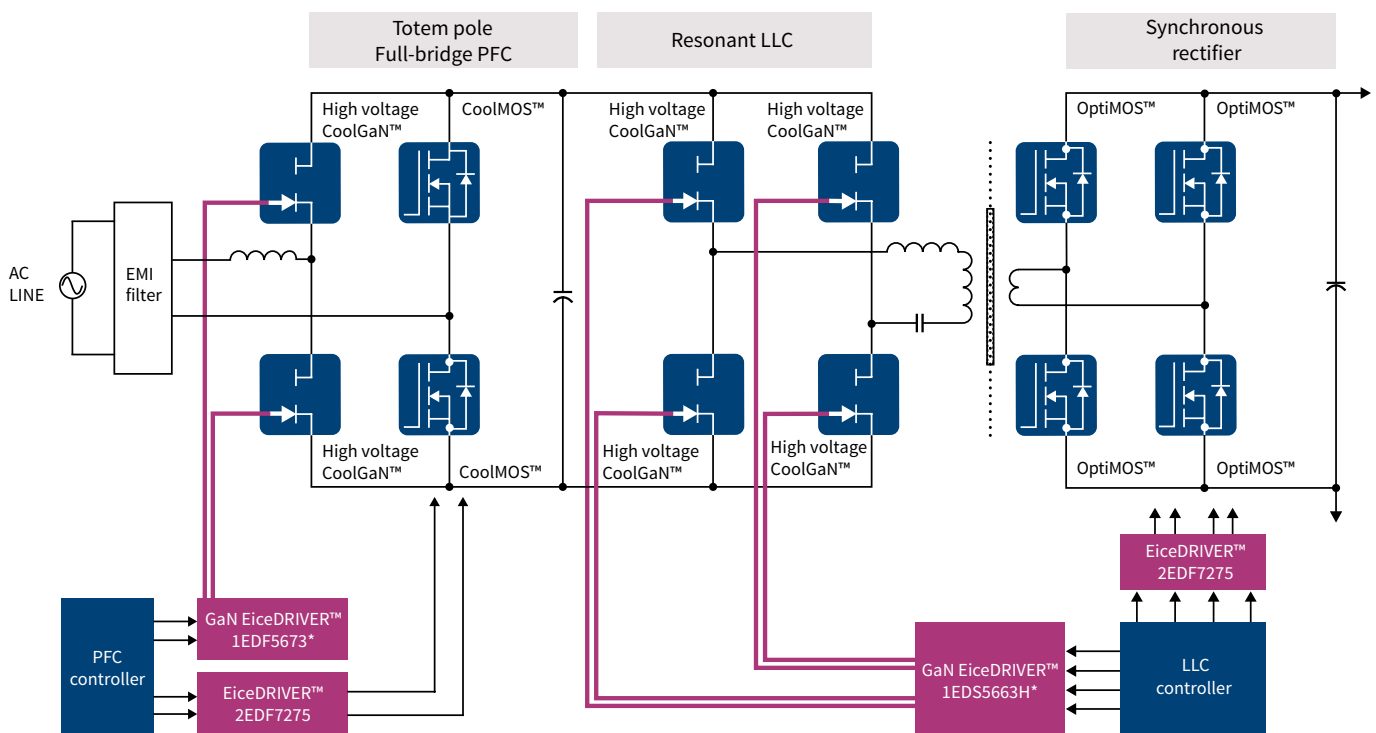



CoolGaN™ in server

Enabling the efficient data flow and storage

Internet of Things (IoT), big data, machine learning and artificial intelligence are driving the power demand for servers and data centers, posing new challenges to SMPS efficiency and form factors. Data center architects face the challenge to increase the delivered power in a given form factor and/or increase efficiency levels to reduce operating costs of server farms.

Both challenges can be addressed with Infineon's CoolGaN™ technology. By implementing CoolGaN™ in a totem pole PFC combined with a LLC DC-DC stage, more than 98.5% system efficiency can be achieved (for 48 V output voltage systems) providing a total of 2 billion kWh annual savings for US data centers (~ 300 million USD annual savings at 0.15 USD / kWh). Additionally, GaN based SMPS solutions will enable doubling of computed power per rack by pushing the power density to >80 W/in³ from today's typical ~30 – 40 W/in³ silicon-based solutions.

The outstanding performance of Infineon CoolGaN™ is demonstrated in a full-bridge totem pole PFC board (EVAL_2500W_PFC_GAN_A), reaching >99% peak efficiency. The system has been designed using CoolGaN™ 600 V, 70 mΩ devices in a PG-DSO-20 bottom-side cooled package (IGO60R070D1).

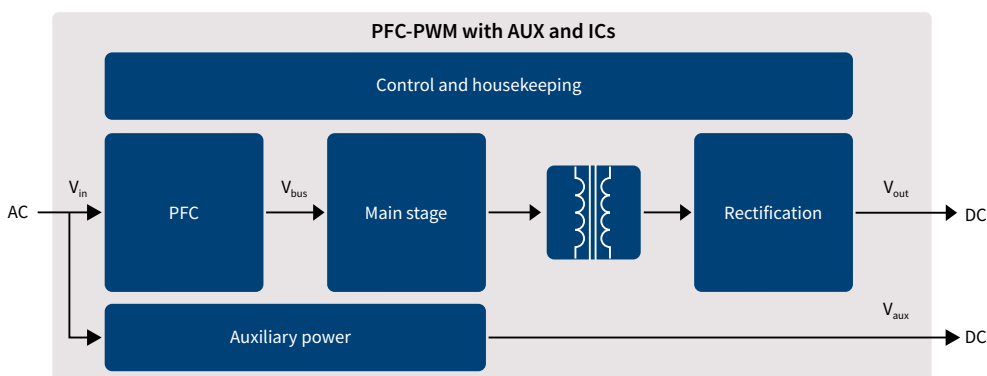

Product portfolio

Functional block	Product category	Topology	Product family	Benefits
PFC	High voltage MOSFETs	CCM/interleaved PFC; TTF	600 V/650 V CoolMOS™ C7 600 V/650 V CoolMOS™ C7 Gold in TOLL	<ul style="list-style-type: none"> Best FOM $R_{DS(on)} \cdot Q_G$ and $R_{DS(on)} \cdot E_{oss}$ Lowest $R_{DS(on)}$ per package Low dependency of switching losses from $R_{g,ext}$
	High voltage GaN	Totem pole PFC	CoolGaN™ 600 V	<ul style="list-style-type: none"> Enable the highest efficiency and highest power density
	SiC diodes	CCM/interleaved PFC	650 V CoolSiC™ Schottky diode generation 5	<ul style="list-style-type: none"> Low FOM $V_F \cdot Q_G$
	Control ICs	CCM PFC IC	ICE3PCS0xG	<ul style="list-style-type: none"> Ease-of-use
	GaN driver IC	Totem pole PFC	EiceDRIVER™ 1EDF5673F and 1EDF5673K	<ul style="list-style-type: none"> Low driving impedance (on-resistance 0.85 Ω source, 0.35 Ω sink) Input-output propagation delay accuracy: ±5 ns Functional and reinforced isolation available
Main stage	High voltage MOSFETs	ITTF	600 V CoolMOS™ C7/P6	<ul style="list-style-type: none"> Fast switching speed for improved efficiency and thermals, low gate charge for enhanced light load efficiency and low power consumption at no load condition Optimized V_{GS} threshold for lower turn-off losses Rugged body diode which prevents device failure during hard commutation
		LLC, half-bridge below 1 kW	600 V CoolMOS™ P7/CFD6	<ul style="list-style-type: none"> Low turn-off losses Low Q_{oss} Low Q_G
		LLC, phase shift full-bridge below 1 kW	600 V CoolMOS™ CFD7 650 V CoolMOS™ CFD2	<ul style="list-style-type: none"> Fast and rugged body diode Optimized low Q_G and soft commutation behavior to reach highest efficiency Highest reliability for 650 V VDS
		ZVS PS FB; LLC, TTF	650 V TRENCHSTOP™ F5	<ul style="list-style-type: none"> Improved ruggedness and high efficiency in low inductance designs
	Control ICs	HB LLC IC	ICE1HS01G-1 ICE2HS01G	<ul style="list-style-type: none"> High efficiency and low EMI
	GaN driver IC	LLC, ZVS phase shift full-bridge	EiceDRIVER™ 1EDS5663H	<ul style="list-style-type: none"> Low driving impedance (on-resistance 0.85 Ω source, 0.35 Ω sink) Input-output propagation delay accuracy: ±5 ns Functional and reinforced isolation available
	GaN e-mode HEMTs	LLC, ZVS phase shift full-bridge	CoolGaN™ 600 V	<ul style="list-style-type: none"> Enable the highest efficiency and highest power density
	Synchronous rectification	Low voltage MOSFETs	HB LLC and centertap	40 V OptiMOS™
ITTF			60 V OptiMOS™	<ul style="list-style-type: none"> High efficiency, low thermals, low V_{DS} overshoot
ZVS PS FB and center-tap			80 V OptiMOS™	<ul style="list-style-type: none"> High efficiency over whole load range, low V_{DS} overshoot and oscillations
Auxiliary power supply	Control ICs	QR/FF flyback CoolSET™	ICE2QRxx80(Z)(G) 800 V ICE3xRxx80J(Z)(G) 800 V ICE5QRxx70A(Z)(G) 700 V ICE5QRxx80A(Z)(G) 800 V	<ul style="list-style-type: none"> Low standby power, high efficiency and robustness An integrated 700 V/800 V superjunction power MOSFET with avalanche capability Burst mode entry/exit to optimize standby power at different low load conditions
Housekeeping	Microcontrollers	-	XMC1xxx	<ul style="list-style-type: none"> Flexibility, HR PWM, digital communication ARM® based standard MCU family and wide family
Conversion	Microcontrollers	-	XMC4xxx	<ul style="list-style-type: none"> Flexibility, HR PWM and digital communication
PFC, PWM/resonant converter, synchronous rectification	Gate driver ICs	Single-channel isolated	EiceDRIVER™ 1EDI Compact	<ul style="list-style-type: none"> 100 ns typical propagation delay time Functional isolation Separate source
		Dual-channel non-isolated	EiceDRIVER™ 2EDNx	<ul style="list-style-type: none"> 8 V UVLO option -10 V input robustness Output robust against reverse current
		Dual-channel isolated	EiceDRIVER™ 2EDFx	<ul style="list-style-type: none"> 35 ns typical propagation delay time Functional isolation 1.5 kV CMTI > 150 V/ns

CoolGaN™ in telecom

Full system solution for telecom power supply

Saving operating and capital expenses, overall power supply footprint and highest solution robustness have been and will remain the major concerns in telecommunication infrastructure development. Infineon's CoolGaN™ solutions address these challenges by providing benchmark efficiency in the entire operation range, maximizing power density and following Infineon's stringent qualification regimen.

A 3.6 kW system has been designed using CoolGaN™ 600 V, 70 mΩ (IGT60R070D1) devices in parallel configuration. The system is based on LLC DC-DC topology with up to 400 V_{DC} input and 52.5 V output voltage, delivering up to 3.6 kW of power at 160 W/inch³ power density. Peak efficiency of this system reaches 98.5% (V_{IN} = 390 V_{DC}, V_{out} = 52.5 V), and remains greater than 97% for loads higher than 20%.

Combining CoolGaN™ in the DC-DC stage with CoolGaN™ based PFC stages will maximize achievable power density and power conversion efficiency, and therefore reduce operating expenses for telecom suppliers. In addition, Infineon's CoolGaN™ devices and technology have been fully qualified based on industrial requirements to ensure ultimate robustness when deployed in telecom SMPS.

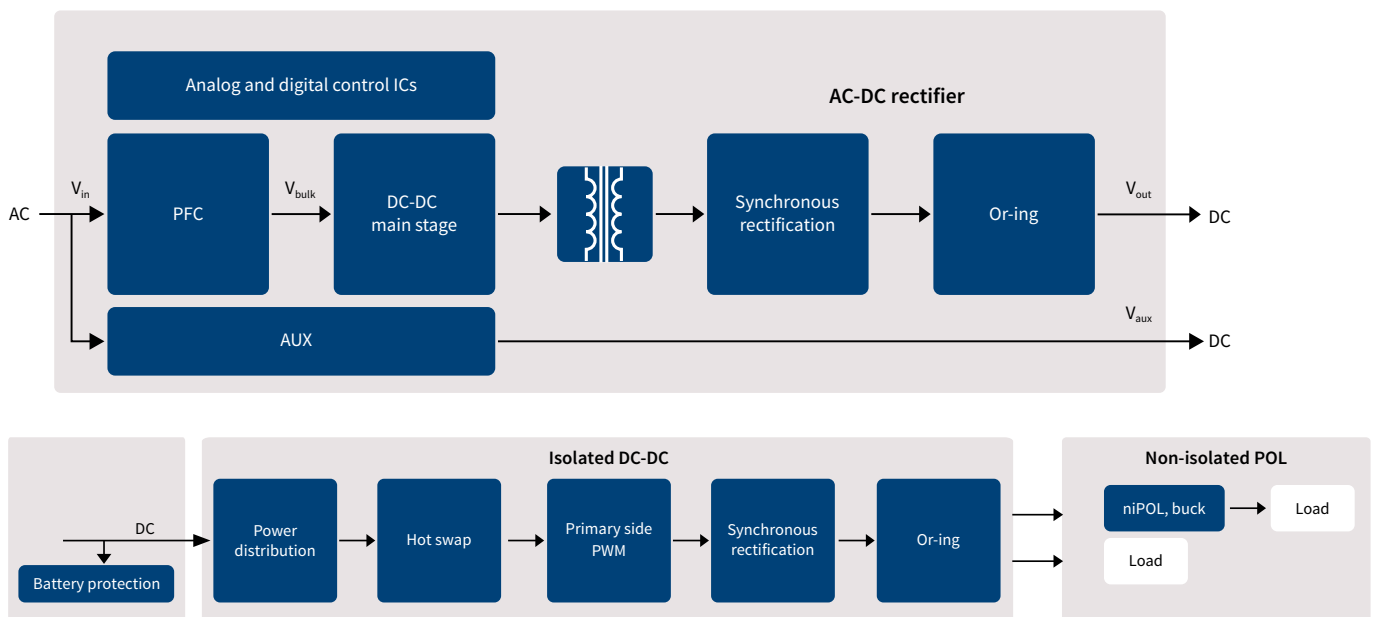

Product portfolio

Functional block	Product category	Topology	Product family	Benefits
PFC	High voltage MOSFETs	CCM/interleaved PFC; TTF	600 V/650 V CoolMOS™ C7	<ul style="list-style-type: none"> > Best FOM $R_{DS(on)} * Q_G$ and $R_{DS(on)} * E_{oss}$ > Lowest $R_{DS(on)}$ per package > Low dependency of switching losses from $R_{g,ext}$
			600 V CoolMOS™ P7	<ul style="list-style-type: none"> > Low turn-off losses > Low Q_{oss} > Low Q_G
	High voltage GaN	CCM totem pole	CoolGaN™ 600 V	<ul style="list-style-type: none"> > Switching at high frequencies (> Si) > Enables high power density
	SiC diodes	CCM/interleaved PFC	650 V CoolSiC™ Schottky diode generation 6	> Low FOM $V_F * Q_C$
	Control ICs	CCM PFC IC	800 V - ICE3PCS0xG	> High PFC and low THD
	GaN driver IC	Totem-pole PFC	EiceDRIVER™ 1EDF5673F and 1EDF5673K	<ul style="list-style-type: none"> > Low driving impedance (on-resistance 0.85 Ω source, 0.35 Ω sink) > Input-output propagation delay accuracy: ±5 ns > Functional and reinforced isolation available

Functional block	Product category	Topology	Product family	Benefits
DC-DC main stage	High voltage MOSFETs	CCM/interleaved PFC; TTF HB LLC	600 V CoolMOS™ C7/P7	<ul style="list-style-type: none"> Fast switching speed for improved efficiency and thermals Low gate charge for enhanced light load efficiency and low power consumption at no load condition Optimized V_{GS} threshold for lower turn-off losses Rugged body diode which prevents device failure during hard commutation
		LLC	600 V CoolMOS™ C7	<ul style="list-style-type: none"> Low turn-off losses Low Q_{oss} Low Q_G
		CCM/interleaved PFC; TTF HB LLC	600 V CoolMOS™ CFD7	<ul style="list-style-type: none"> Best-in-class Q_{rr} and t_{rr} level Significant reduced Q_G Improved efficiency over previous CoolMOS™ fast body diode series
	Control ICs	HB LLC IC	ICE1HS01G-1, ICE2HS01G	High efficiency and low EMI
	GaN driver IC	LLC, ZVS phase shift full-bridge	EiceDRIVER™ 1EDS5663H	<ul style="list-style-type: none"> Low driving impedance (on-resistance 0.85 Ω source, 0.35 Ω sink) Input-output propagation delay accuracy: +/- 5 ns Functional and reinforced isolation available
	GaN e-mode HEMTs	LLC, ZVS phase shift full-bridge	CoolGaN™ 600 V	Enable the highest efficiency and highest power density
Synchronous rectification	Low voltage MOSFETs	Synchronous rectification MOSFET	OptiMOS™ 80-150 V	<ul style="list-style-type: none"> Industry's lowest FOM ($R_{DS(on)} * Q_G$) leading to high efficiency at good price/performance Low voltage overshoots enabling easy design-in Industry's lowest $R_{DS(on)}$ Highest system efficiency and power density Outstanding quality and reliability Reduces the need for a snubber circuit
Auxiliary power supply	Control ICs	5 th generation QR/FF flyback CoolSET™	QR 800 V - ICE5QRxx80Ax FF 800 V - ICE5xRxx80AG	<ul style="list-style-type: none"> Quasi-resonant switching operation for high efficiency and low EMI signature Fixed frequency switching operation for ease-of-design – 100 KHz and 125 KHz Fast and robust start-up with cascode configuration Robust protection with adjustable line input over-voltage protection, V_{CC} and CS pin short-to-ground protection Optimized light-load efficiency with selectable burst mode entry/exit profile Frequency reduction for mid and light load condition to reduce switching losses and increase efficiency Direct feedback and regulation with integrated error amplifier for non-isolated output High power delivery of up to 42 W with 800 V heatsink-less SMD package CoolSET™
Housekeeping	Microcontrollers	-	XMC1xxx	<ul style="list-style-type: none"> Flexibility, HR PWM, digital communication ARM® based standard MCU family and wide family
Conversion	Microcontrollers	-	XMC4xxx	<ul style="list-style-type: none"> Flexibility, HR PWM, digital communication ARM® based standard MCU family and wide family
PFC, PWM/resonant converter, synchronous rectification	Gate driver ICs	Single channel non-isolated	EiceDRIVER™ 1EDN751x	<ul style="list-style-type: none"> 8 V UVLO option (-10 V input robustness Output robust against reverse current
		Single channel non-isolated	EiceDRIVER™ 1EDN7550	<ul style="list-style-type: none"> 8 V UVLO option (-10 V input robustness True differential inputs for >100 V_{AC} ground shift robustness
		Dual channel non-isolated	EiceDRIVER™ 2EDN7x	<ul style="list-style-type: none"> 8 V UVLO option (-10 V input robustness Output robust against reverse current
		Dual channel junction isolated	EiceDRIVER™ 2EDL811x*	<ul style="list-style-type: none"> 20 ns typ. propagation delay time 20 V bootstrap capability on high side (-7 V input robustness
		Single channel isolated	EiceDRIVER™ 1EDi Compact	<ul style="list-style-type: none"> 100 ns typ. propagation delay time Functional isolation 1.2 kV separate source and sync outputs
		Dual channel isolated	EiceDRIVER™ 2EDFx	<ul style="list-style-type: none"> 35 ns typ. propagation delay time Functional isolation 1.5 kV CMTI > 150 V/ns
		Dual channel isolated	EiceDRIVER™ 2EDSx	<ul style="list-style-type: none"> 35 ns typ. propagation delay time Reinforced (safe) isolation 6 kV CMTI > 150 V/ns
Or-ing	Low voltage MOSFETs	Or-ing MOSFET	OptiMOS™ 60-200 V	<ul style="list-style-type: none"> Industry's lowest FOM ($R_{DS(on)} * Q_G$) leading to high efficiency at good price/performance Low voltage overshoots enabling easy design-in
Battery protection	Low voltage MOSFETs	MOSFET	OptiMOS™ 60-150 V	
Isolated DC-DC	Low voltage MOSFETs	Primary side PWM MOSFET	OptiMOS™ 60-200 V	<ul style="list-style-type: none"> Industry's lowest $R_{DS(on)}$ Highest system efficiency and power density Outstanding quality and reliability Reduces the need for a snubber circuit
			StrongIRFET™ 60-200 V	
			Small Signal 60-200 V	
	Synchronous rectification MOSFET	OptiMOS™ 40-100 V		
		StrongIRFET™ 40-100 V		
	Or-ing MOSFET	OptiMOS™ 25-30 V		
StrongIRFET™ 25-30 V				

* Upcoming Q1 2019

CoolGaN™ in wireless charging

Enabling the next level of charging

The prospect of wirelessly charging our mobile devices has been around for years and has recently become reality with the proliferation of inductive wireless charging technology. However, to make wireless charging truly ubiquitous and offer improved end-user convenience (e.g., improved freedom of positioning), wireless charging solutions need to further evolve, and likely will apply the magnetic-resonance technology over time. For the latter, high transmission frequencies (multiple MHz) are required, which poses significant challenges to standard silicon power technologies within the transmitter and the receiver devices. Infineon is developing resonant solutions for transmitter, receiver and adapter to serve the upcoming requirements of various wireless charging applications.

Due to its significantly reduced parasitic capacitances, CoolGaN™ technology is the ideal choice when switching at frequencies in the MHz range (e.g., 6.78 MHz as required by the resonant AirFuel wireless charging standard).

Class E and class D topologies are the main topologies of choice when resonant wireless charging is applied. Both topologies reduce switching losses by transitioning between on- and off-switching position of the power devices at zero volt across the respective power switch. In the class D ZVS topology, lower breakdown voltage devices can be used, thereby increasing the overall system efficiency. In the class E topology, however, simpler driver architecture (low-side only) and only a single switch per class E branch offer the prospects of reduced system cost. CoolGaN™ is ideally suited to address both topologies by either maximizing overall system performance (in class D implementations) or reducing overall system solution cost (in class E implementation).

Infineon's CoolGaN™ devices have been successfully tested in a 16 W class E wireless charging demonstrator system as well as in customer implementations operating at 6.78 MHz at higher watt class.

Having a reliable partner by your side is key to maximize the performance and consumer appeal of your wireless charging designs. At Infineon, we help you master your design challenges with our broad selection of semiconductors and our powerful CoolGaN™ products.

System diagram: resonant class E single-ended with CoolGaN™

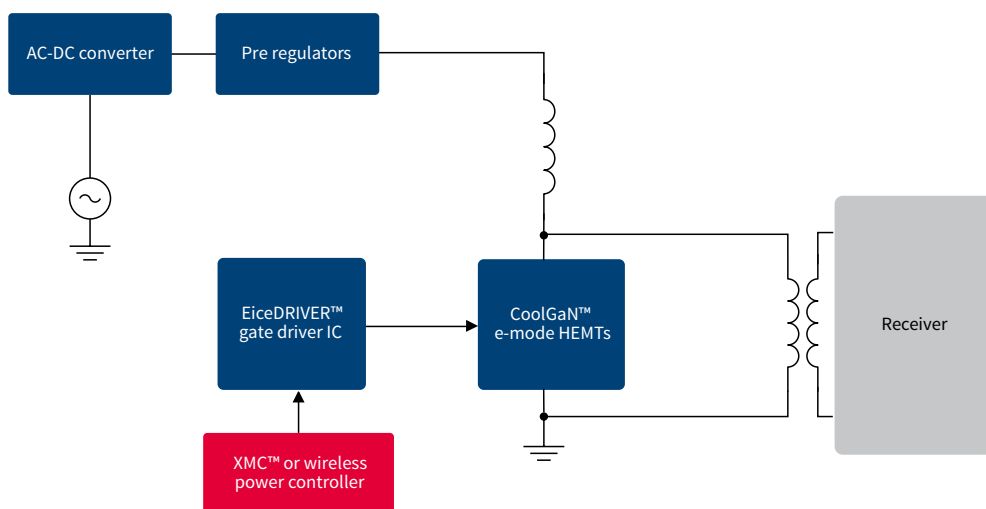

Target applications

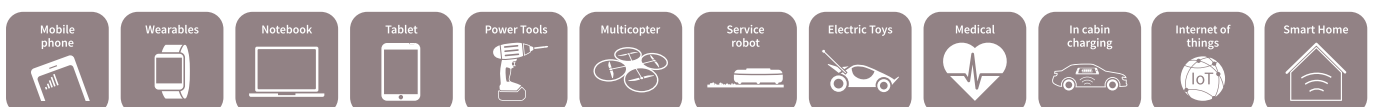

Components for resonant (AirFuel) and high frequency solutions

Sub-application	Voltage class	Package	Part number	$R_{DS(on) \text{ max @ } V_{GS} = 4.5 \text{ V}}$ [mQ]	Q_c typical [nC]	C_{oss} typical [pF]	Topology
Inverter MOSFETs	30 V	PQFN 2 x 2 Dual	IRLHS6376PbF	48	2.8	32	Class D
		PQFN 3.3 x 3.3 Dual	BSZ0909ND	25	1.8	120	Class D
			BSZ0910ND	13	5.6	230	Class D
		SOT 23	IRLML0030pbf	33	2.75	84	Class D
	40 V	SOT 23	IRLML0040pbf	62	2.8	49	Class D
	60 V	SOT 23	IRLML0060pbf	98	2.6	37	Class D
	80 V	PQFN 2 x 2	IRL80HS120	32	2.5	68	Class D/E
	100 V	PQFN 2 x 2	IRL100HS121	42	2.7	62	Class D/E
	150 V	PQFN 3.3 x 3.3	BSZ900N15NS3	75**	4.1**	46	Class E
			BSZ520N15NS3	42**	7.2**	80	Class E
			BSZ900N20NS3	78**	7.2**	52	Class E
			BSZ22DN20NS3	200**	3.5**	24	Class E
			BSZ12DN20NS3	111**	5.4**	39	Class E
200 V		BSZ42DN25NS3	375**	3.6**	21	Class E	
250 V							
Driver ICs	EiceDRIVER™ 2EDL71*						
	EiceDRIVER™ 1EDN7512, 2EDN7524						
	EiceDRIVER™ GaN driver IC 1EDS5663H, 1EDF5673F, 1EDF5673K						
GaN e-mode HEMTs	CoolGaN™ 600 V e-mode GaN HEMT IGT60R190D1S (HDSOF-8-3)						
Microcontroller	XMC™ MCU and wireless power controller XMC™-SC* (including software IP)						
Voltage regulators	IR3841MPbF, IFX20002, IFX91041EJV50, IFX90121ELV50, IFX81481ELV						
Small signal MOSFETs	Please check online						

* Coming soon

** $V_{GS} = 8 \text{ V}$

Find the right solutions for your wireless charging designs in four steps

For Infineon's complete offering of devices for inductive, resonant or in-cabin car charging access the Infineon wireless charging selection tool that allows you to find the right solutions for your designs in just four steps: select the application, power range, standard and the topology you want to apply and get an overview of Infineon's most recommended offerings.



GaN EiceDRIVER™ family

Single-channel isolated gate-driver ICs for enhancement mode GaN HEMTs

Release the full potential of GaN e-mode HEMTs with Infineon's silicon-based drivers. The combined solution of CoolGaN™ and EiceDRIVER™ reduces the complexity in customer design, bringing ease-of-use into modern topologies.



Interested? Learn more at:
www.infineon.com/gan

CoolGaN™ in adapter and charger

Breakthrough in power density

Travelling with multiple and often clunky chargers and adapters for phones, tablets and laptops has been a nuisance for many consumers, and often leads to frustrations due to the additional weight and required space. Over the past years, manufacturers of chargers and adapters became increasingly aware of these issues and a trend towards higher power density and consequently smaller devices has emerged. Today, the typical power topology used in such systems is a flyback power conversion topology, and the form factor is limited by the efficiency achievable at 90 V_{AC} input voltage and full load. The highest power density systems available today reach ~12 W/in³ (for 65 W maximum output power).

Infineon's CoolGaN™ supports a breakthrough with respect to power density for adapter and charger systems, enabling ~20 W/in³ power density systems (for 65 W maximum output power). This advantage can be realized by implementing Infineon's CoolGaN™ in a half-bridge topology that allows increasing switching frequency and efficiency simultaneously.

Functional block	Product category	Topology	Product family	Benefits
Flyback converter	High voltage MOSFETs	Flyback	600 V/700 V/800 V CoolMOS™ P7	<ul style="list-style-type: none"> › Fast switching speed for improved efficiency and thermals › Reduced gate charge for enhanced light load efficiency › Optimized V_{GS} threshold for lower turn-off losses
		Active clamp flyback Hybrid flyback	CoolGaN™ 600 V	<ul style="list-style-type: none"> › Highest efficiency › Highest power density
	Low voltage MOSFETs	Flyback/auxiliary synchronous rectification	OptiMOS™ 100 V-150 V	<ul style="list-style-type: none"> › Low conduction losses and reduced overshoot › Logic level can support low voltage gate drive to achieve high efficiency
	Control ICs	QR flyback IC	ICE2QS03G, ICE5QSAG	› High efficiency and low standby power
		FFR flyback IC	IDP2105	› High power density and digital control
PFC	High voltage MOSFETs	DCM PFC	600 V CoolMOS™ P7	<ul style="list-style-type: none"> › Fast switching speed for improved efficiency › Reduced gate charge for enhanced light load efficiency › Optimized V_{GS} threshold for lower turn-off losses
		ZVS totem pole	CoolGaN™ 600 V	<ul style="list-style-type: none"> › Highest efficiency contribution via less parasitic parameter › Space saving with SMD smaller package
		DCM PFC	650 V Rapid 1	<ul style="list-style-type: none"> › Easy control of switching behavior due to higher R_{G,int} › Better transition losses versus standard MOSFET
	Boost diode	DCM/PFC	650 V Rapid 1	› Low conduction losses
	Control ICs	DCM PFC ICs	TDA4863G, IRS2505LTRPBF	<ul style="list-style-type: none"> › Simple external circuitry › High power factor and low THD
Main stage	High voltage MOSFETs	HB LLC	600 V CoolMOS™ P7	<ul style="list-style-type: none"> › Fast switching speed for improved efficiency and thermals › Reduced gate charge for enhanced light load efficiency › Optimized V_{GS} threshold for lower turn-off losses
			CoolGaN™ 600 V	<ul style="list-style-type: none"> › Highest efficiency › Highest power density
Synchronous rectification	Low voltage MOSFETs	Synchronous rectification	OptiMOS™ 5 100 V-150 V	<ul style="list-style-type: none"> › Low conduction losses, reduced overshoot › Logic level switching
	Control ICs	Synchronous rectification	IR1161LTRPBF	<ul style="list-style-type: none"> › High efficiency › Simple external circuitry

CoolGaN™ for class D audio

Maximize audio performance

Class D audio amplifiers have practically eliminated class A/B amplifiers as they offer greatly improved energy efficiency, and thereby enable small form factor designs for even high power amplification. In addition, class D audio amplifiers theoretically can reach 0% distortion and 100% energy efficiency in case the power switch in the class D stage is an ideal switch that results in excellent sound quality and practically negligible thermal design limitations.

CoolGaN™ 400 V is tailored for premium HiFi home audio, professional, and aftermarket car audio systems where end users demand every detail of their high-resolution soundtracks. These have been conventionally addressed by bulky linear or tube amplifiers. With CoolGaN™ 400 V as class D output stage, audio designers are able to deliver the best listening experience to their prospective audio fans.

Infineon's CoolGaN™ technology allows approaching the theoretical ideal performance of class D audio amplifiers due to its unique characteristics, perfectly suited for this application: zero reverse recovery charge (Q_{rr}) of the body diode, linear input and output capacitances, and extremely fast switching speeds (lowest Q_{GD} and R_g) result in ideal switching waveforms, close to an ideal switch. These ideal switching waveforms are the prerequisite to maximize audio performance and minimize power losses in class D audio amplifiers.

Infineon's audio solutions

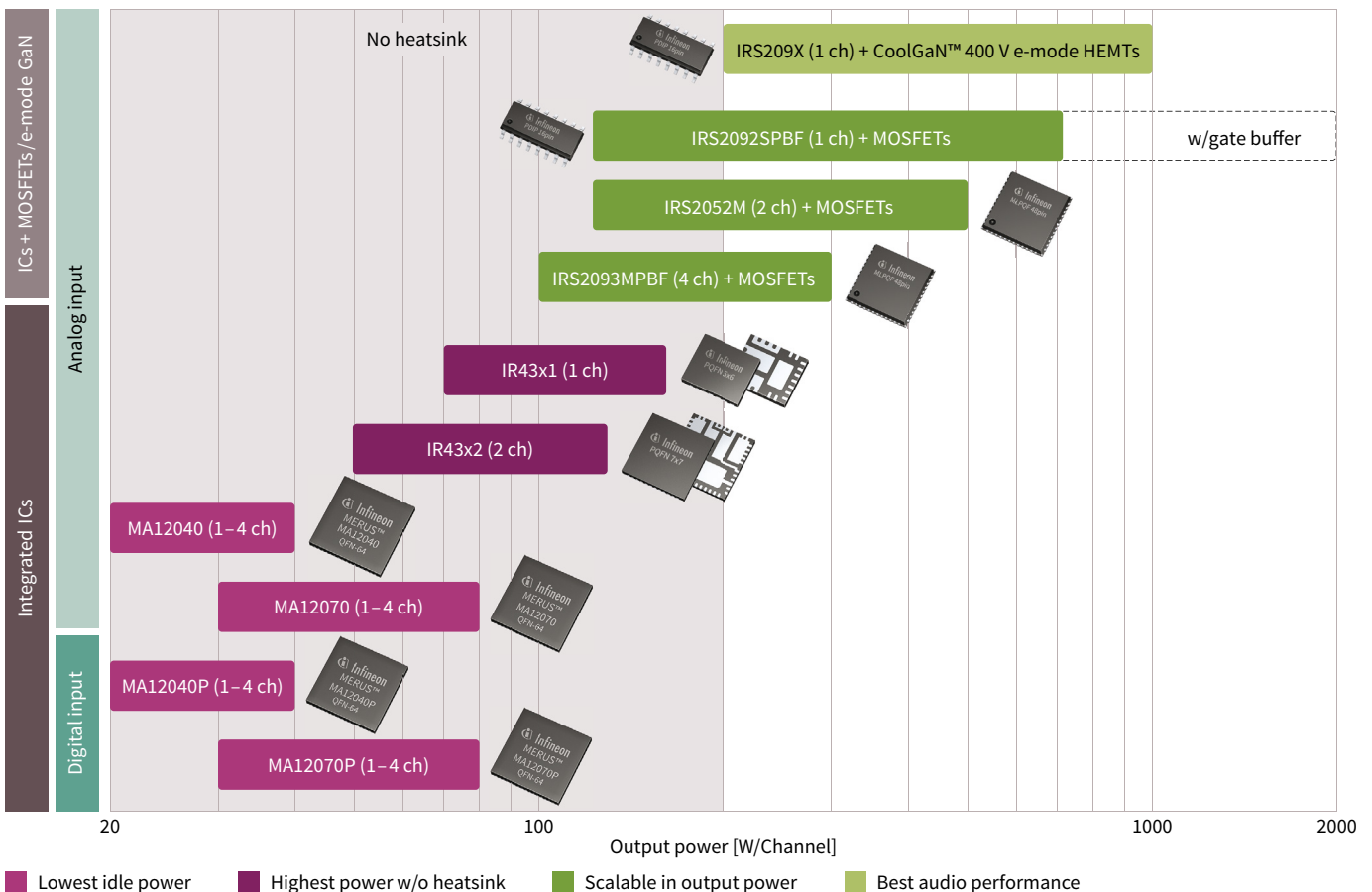

CoolGaN™ 400 V e-mode GaN HEMTs for class D audio product offering

	PG-HSOF-8-3 (TO-leadless)
P_{max}	Up to 200 W
$R_{DS(on) max.}$	70 Ω
Typical part number	IGT40R070D1 E8220

Class D driver IC selection guide

		IRS20965S	IRS20957SPBF	IRS2092SPBF	IRS2052M	IRS2093MPBF	IRS2452AM
Specifications	Number of audio channels	1	1	1	2	4	2
	Max. power per channel	500 W	500 W	500 W	300 W	300 W	500 W
	Supply voltage	± 100 V	± 100 V	± 100 V	± 100 V	± 100 V	± 200 V
	Gate sink/source current	2.0/2.0 A	1.2/1.0 A	1.2/1.0 A	0.6/0.5 A	0.6/0.5 A	0.6/0.5 A
Features	Over-current protection	✓	✓	✓	✓	✓	✓
	Over-current flag	✓					
	PWM input	✓	✓				
	Floating input	✓	✓	✓	✓	✓	✓
	Dead time		✓	✓	✓	✓	✓
	Protection control logic	✓	✓	✓	✓	✓	✓
	PWM controller			✓	✓	✓	✓
	Clip detection				✓		
	Click noise reduction			✓	✓	✓	✓
	Temperature sensor input				✓		✓
	Thermal shutdown				✓		
	Clock input				✓		✓
	Package type	16pin SOIC narrow	16pin SOIC narrow	16pin SOIC narrow	MLPQ48	MLPQ48	MLPQ32
	Reference design	-	IRAUDAMP4A IRAUDAMP6	IRAUDAMP5 IRAUDAMP7S IRAUDAMP7D IRAUDAMP9	IRAUDAMP10	IRAUDAMP8	EVAL_IRAUDAMP23

Integrated class D audio modules

		IR4301M	IR4321M	IR4311M	IR4302M	IR4322M	IR4312M
Specifications	Number of audio channels	1	1	1	2	2	2
	Max. power per channel	160 W	90 W	45 W	130 W	100 W	40 W
	Supply voltage	$\sim \pm 34$ V or 68 V	$\sim \pm 25$ V or 50 V	$\sim \pm 15$ V or 32 V	$\sim \pm 32$ V or 64 V	$\sim \pm 25$ V or 50 V	$\sim \pm 16$ V or 32 V
	Max. PWM frequency	500 kHz	500 kHz	500 kHz	500 kHz	500 kHz	500 kHz
Features	Differential audio input	✓	✓	✓	✓	✓	✓
	Over-current protection	✓	✓	✓	✓	✓	✓
	Integrated power MOSFET	✓ (80 V)	✓ (60 V)	✓ (40 V)	✓ (80 V)	✓ (60 V)	✓ (40 V)
	PWM controller	✓	✓	✓	✓	✓	✓
	Thermal shutdown	✓	✓	✓	✓	✓	✓
	Click noise reduction	✓	✓	✓	✓	✓	✓
	Clip detection				✓	✓	✓
	Fault output				✓	✓	✓
	Package type	5 x 6 mm QFN	5 x 6 mm QFN	5 x 6 mm QFN	7 x 7 mm QFN	7 x 7 mm QFN	7 x 7 mm QFN
Reference design	IRAUDAMP12 IRAUDAMP19	IRAUDAMP21	IRAUDAMP15	IRAUDAMP16 IRAUDAMP17	IRAUDAMP22	IRAUDAMP18	

Product portfolio

Product name	Peak output [W]	Input type	Supply voltage [V]	Main features	Orderable part number
MA12040P	2x40	I ² S digital audio input	4–18	Digital volume control and limiter	MA12040PXUMA1
MA12040	2x40	Analog audio input	4–18	Selectable gain (20 dB/26 dB)	MA12040XUMA1
MA12070P	2x80	I ² S digital audio input	4–26	Digital volume control and limiter	MA12070PXUMA1
MA12070	2x80	Analog audio input	4–26	Selectable gain (20 dB/26 dB)	MA12070XUMA1

CoolGaN™ boards

Driving the innovation

Infiniteon's CoolGaN™ devices benefit from Infineon's innovative spirit towards challenging applications like telecom rectifiers, SMPS servers, or class D audio where CoolGaN™ technology proved to be highly reliable. It is the most rugged and reliable solution in the market, available in high performing SMD packages to fully exploit the benefits of GaN. With a set of available evaluation boards, comprehensive online training materials and a global support structure Infineon allows for an easier transition to these new technologies and allows for faster prototyping and go-to-market.

PFC for server SMPS and telecom rectifiers – 99.3% peak efficiency

- > 2.5 kW totem pole PFC using IGO60R070D1 (70 mΩ/600 V in DSO-20-85 bottom-side cooling)
- > Order code: EVAL_2500W_PFC_GAN_A



LLC for telecom rectifiers – ~160 W/in³ @ >98% peak efficiency

- > 3.6 kW LLC, 52 V V_{out} , 350 kHz using IGT60R070D1 in primary side (70 mΩ/600 V in TO-leadless)
- > Order code: EVAL_3K6W_LLC_GAN*



High frequency (>1 MHz) half-bridge platform

- > Functional board with 2 x 1EDF5673K in LGA package, 2 x IGT60R070D1 (DSO-20-87 top-side cooling packages)
- > Order code: EVAL_1EDF_G1_HB_GAN



200 W + 200 W class D audio amplifier

- > 200 W + 200 W class D audio amplifier boards, $\pm 75 V_{in}$ using IGT40R070D1 E8220 (70 mΩ in TO-leadless package)
- > Order code: EVAL_AUDAMP24*

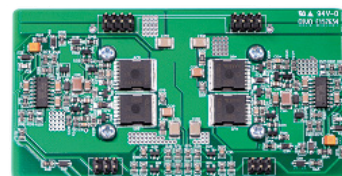

*Order on request

Discover 3D models of the boards and get access to GaN training materials:
www.infineon.com/gan

CoolGaN™ product portfolio

Infineon's solutions to master power technologies of tomorrow

CoolGaN™ 400 V e-mode HEMTs



Package	H5OF-8-3 (TO-leadless)
P_{max}	Up to 200 W
$R_{DS(on) max.}$	70 Ω
Typical part number	IGT40R070D1 E8220

CoolGaN™ 600 V e-mode HEMTs



$R_{DS(on) max.}$	DSO-20-85 Bottom-side cooling	DSO-20-87 Top-side cooling	H5OF-8-3 (TO-leadless)	LSON-8-1 DFN 8x8
35 m Ω	IGO60R035D1**	IGOT60R035D1**	IGT60R035D1**	
70 m Ω	IGO60R070D1	IGOT60R070D1	IGT60R070D1	IGLD60R070D1
190 m Ω			IGT60R190D1S*	IGLD60R190D1

*Standard grade

**Coming soon

GaN EiceDRIVER™ product portfolio

Release the full potential of the e-mode HEMTs

Infineon's CoolGaN™ devices, driven by single-channel isolated gate driver ICs from the GaN EiceDRIVER™ family, aim to unlock the full potential of GaN.

GaN EiceDRIVER™ family product portfolio



Produkt	Package	Input to output isolation				Propagation delay accuracy	Typ. high level (sourcing) output resistance	Typ. low level (sinking) output resistance	SP number
		Isolation class	Rating	Surge testing	Certification				
1EDF5673K	LGA, 13-pin 5x5 mm	functional	$V_{IO} = 1.5 \text{ kV}_{DC}$	n.a.	n.a.	-6 ns/+7 ns	0.85 Ω	0.35 Ω	SP002447622
1EDF5673F	DSO, 16-pin 150 mil	functional	$V_{IO} = 1.5 \text{ kV}_{DC}$	n.a.	n.a.	-6 ns/+7 ns	0.85 Ω	0.35 Ω	SP003194020
1EDS5663H	DSO, 16-pin 300 mil	reinforced	$V_{IOTM} = 8 \text{ kV}_{pk}$ $V_{ISO} = 5.7 \text{ kV}_{rms}$	$V_{ISOM} > 10 \text{ kV}_{pk}$	VDE0884-10 UL1577	-6 ns/+7 ns	0.85 Ω	0.35 Ω	SP002753980

www.infineon.com/gan

www.infineon.com/gan-eicedriver



CoolGaN™ nomenclature

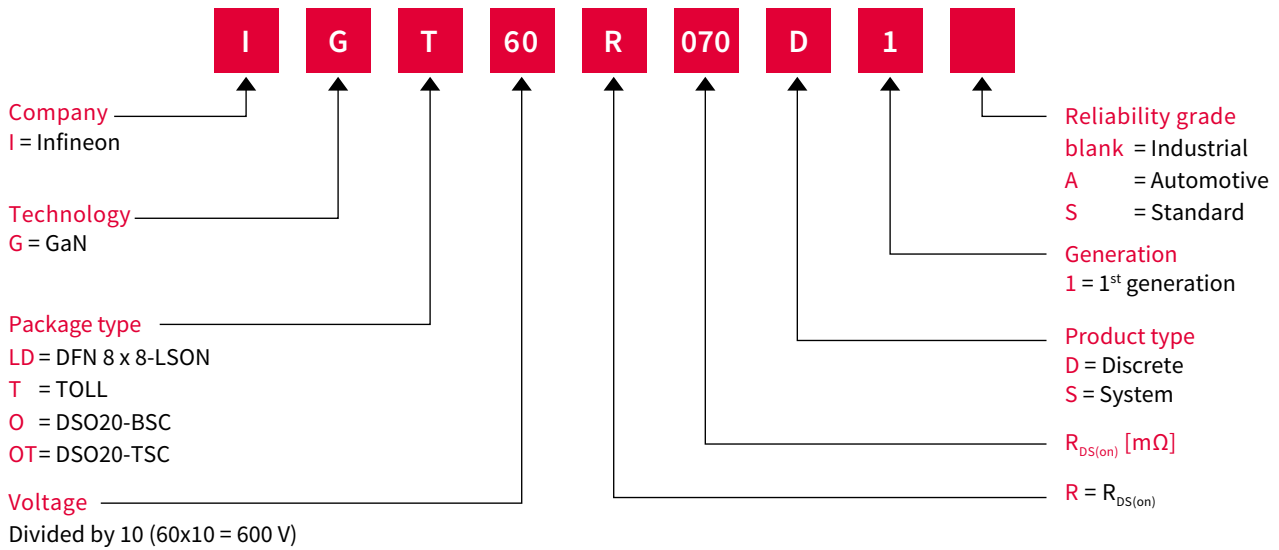

A world leader
in semiconductor solutions



Our vision

We are the link between the
real and the digital world.

Our values

We commit
We partner
We innovate
We perform

Our mission

We make life
easier, safer
and greener.

Part of your life. Part of tomorrow.

Where to buy

Infineon distribution partners and sales offices:

www.infineon.com/WhereToBuy

Service hotline

Infineon offers its toll-free 0800/4001 service hotline as one central number, available 24/7 in English, Mandarin and German.

- > Germany 0800 951 951 951 (German/English)
- > China, mainland 4001 200 951 (Mandarin/English)
- > India 000 800 4402 951 (English)
- > USA 1-866 951 9519 (English/German)
- > Other countries 00* 800 951 951 951 (English/German)
- > Direct access +49 89 234-0 (interconnection fee, German/English)

* Please note: Some countries may require you to dial a code other than "00" to access this international number.
Please visit www.infineon.com/service for your country!



Mobile product catalog

Mobile app for iOS and Android.

www.infineon.com

Published by
Infineon Technologies Austria AG
9500 Villach, Austria

© 2019 Infineon Technologies AG.
All rights reserved.

Order number: B152-I0892-V1-7600-EU-EC-P
Date: 09 / 2019

Please note!

THIS DOCUMENT IS FOR INFORMATION PURPOSES ONLY AND ANY INFORMATION GIVEN HEREIN SHALL IN NO EVENT BE REGARDED AS A WARRANTY, GUARANTEE OR DESCRIPTION OF ANY FUNCTIONALITY, CONDITIONS AND/OR QUALITY OF OUR PRODUCTS OR ANY SUITABILITY FOR A PARTICULAR PURPOSE. WITH REGARD TO THE TECHNICAL SPECIFICATIONS OF OUR PRODUCTS, WE KINDLY ASK YOU TO REFER TO THE RELEVANT PRODUCT DATA SHEETS PROVIDED BY US. OUR CUSTOMERS AND THEIR TECHNICAL DEPARTMENTS ARE REQUIRED TO EVALUATE THE SUITABILITY OF OUR PRODUCTS FOR THE INTENDED APPLICATION.

WE RESERVE THE RIGHT TO CHANGE THIS DOCUMENT AND/OR THE INFORMATION GIVEN HEREIN AT ANY TIME.

Additional information

For further information on technologies, our products, the application of our products, delivery terms and conditions and/or prices, please contact your nearest Infineon Technologies office (www.infineon.com).

Warnings

Due to technical requirements, our products may contain dangerous substances. For information on the types in question, please contact your nearest Infineon Technologies office.

Except as otherwise explicitly approved by us in a written document signed by authorized representatives of Infineon Technologies, our products may not be used in any life-endangering applications, including but not limited to medical, nuclear, military, life-critical or any other applications where a failure of the product or any consequences of the use thereof can result in personal injury.