

## Introduction

The SA50-28 is an isolated DC-to-DC converter capable of delivering up to 50W of output power in a small size design. The SA family provides a radiation-hardened option with top class TID and SEE performance for space and military applications. With forward converter topology and a patented magnetic feedback, the SA50-28 is optimized for applications where isolated DC voltage conversion is required. The discrete surface mount design facilitates customization with reasonable lead time and modest NRE cost.

To achieve MIL-STD-461 EMI compliance, an external filter is required. Off-the-shelf filters, such as Microchip's SF200-28-28S, are available.

As the only non-hybrid space-grade DC-DC power converter module in the market, the SA50-28 series excels in its robustness in applications with  $8.22 \times 10^6$  hours of MTBF.

The SA50-28 is available in a 3.055" x 2.055" x 0.5" package.

## Table of Contents

Introduction.....	1
1. Benefits and Features.....	3
2. Typical Application Circuit.....	4
3. Absolute Maximum Ratings.....	5
4. Electrical Parameters.....	6
5. Radiation Specification (Note 1).....	11
6. Parallel Operation (Notes).....	12
7. Sample Electrical Waveforms.....	13
8. Pin Configuration.....	15
9. Pin Description.....	16
10. Radiation Performance (-H) Hardened.....	17
11. Radiation Performance (-P).....	18
12. Mechanical Outline (Axial Pins) Package.....	19
13. Mechanical Outline (Radial Pins) Package.....	20
14. Qualification Test (Reference Report QTR996).....	21
15. ATP Screening Test (-H) Hardened.....	22
16. ATP Screening Test (-P) Prototypes.....	23
17. Ordering Information.....	24
18. Revision History.....	25
Microchip Information.....	26
The Microchip Website.....	26
Product Change Notification Service.....	26
Customer Support.....	26
Microchip Devices Code Protection Feature.....	26
Legal Notice.....	26
Trademarks.....	27
Quality Management System.....	28
Worldwide Sales and Service.....	29

## 1. Benefits and Features

- Up to 50W Output Power (Parallel Up to Four for Higher Power)
- 20 VDC to 40 VDC Input Range
- Five Output Configurations Available

Output	Base Part number
3.3V	SA50-28-3R3S
5V	SA50-28-5S
12V	SA50-28-12S
15V	SA50-28-15S
28V	SA50-28-28S

- Up to 82% Efficiency @ Full Load
- <1% Output Ripple
- Forward Topology
- Patented Magnetic Feedback
- Adjustable Output with Remote Adjust
- Inhibit Pin for Electrical ON/OFF
- Capable of Paralleling Up to Four Identical Units
- Isolated Synchronization Input
- Low Mass 120g
- Flight Proven Technology with  $>8 \times 10^6$  Hours of MTBF
- Product is Classified as EAR99
- Customization of Input/Output Voltages Available Upon Request

### Radiation Performance

- TID >100 krad (Si) and 30 krad (Si) ELDRS (<10 mrad/s) per MIL-STD-883 Method 1019
- SEE (SEGR, SEB, SET, SEL) Immunity 82 MeV·cm<sup>2</sup>/mg

## 2. Typical Application Circuit

Figure 2-1. SA50-28 Single Typical Application Circuit

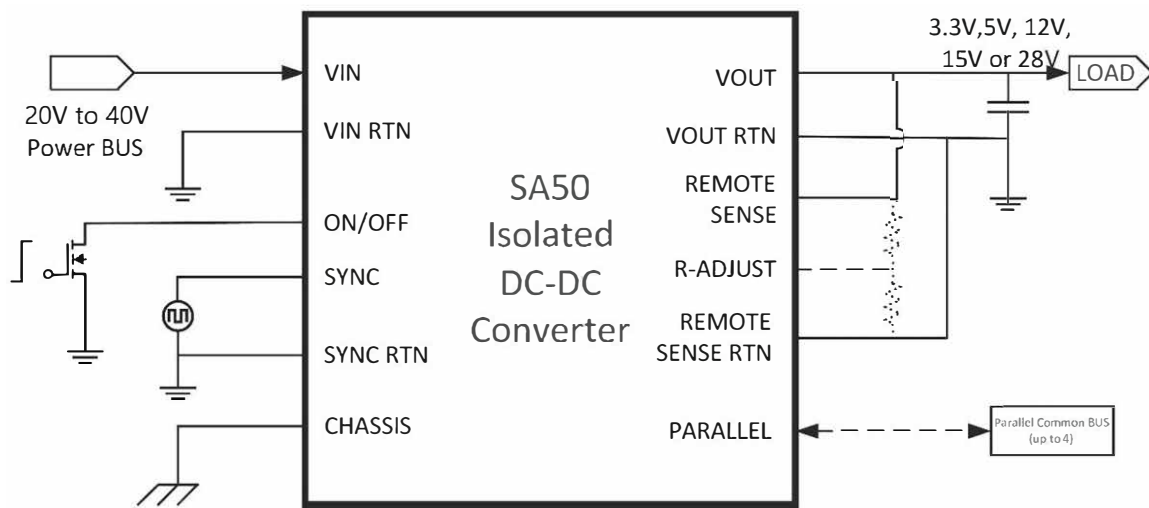

### 3. Absolute Maximum Ratings

Rating	Value
$V_{IN}$ range	-0.5 VDC to 60 VDC
Output power	50W
Lead temperature	300°C for 10s
Operating temperature	-55°C to 125°C
Storage temperature	-55°C to 125°C
Shock	1500 gpk, 0.5 ms, ½ sine
Constant acceleration	50g
Random vibration	24.06 grms, 50 Hz to 2000 Hz

## 4. Electrical Parameters

This section shows the electrical parameters of the SA50-28 Single Series device under the following conditions unless otherwise specified:

Parameter	Output	Conditions	Min	Nom	Max	Units
<b>Input voltage</b>						
(V <sub>IN</sub> )	—	Note 2	20	28	40	V
<b>Output voltage</b>						
(V <sub>OUT</sub> )	28V	I <sub>OUT</sub> = 100% rated load	27.73	28.00	28.27	V
	15V		14.85	15.00	15.15	
	12V		11.88	12.00	12.12	
	5V		5.05	5.10	5.15	
	3.3V		3.27	3.30	3.33	
<b>Output Voltage Adjust</b>						
(V <sub>ADJ</sub> )	—	—	5	—	—	%
<b>Output power</b>						
(P <sub>OUT</sub> )	28V	Note 13 In all cases Output power must be kept within P <sub>OUT</sub> rating.	0	—	50	W
	15V				50	
	12V				50	
	5V				50	
	3.3V				33	
<b>Output current</b>						
(I <sub>OUT</sub> )	28V	—	0	—	1.8	A
	15V				3.3	
	12V				4.2	
	5V				10	
	3.3V				10	

.....continued						
Parameter	Output	Conditions	Min	Nom	Max	Units
<b>Line regulation</b>						
(V <sub>RLINE</sub> )	28V	V <sub>IN</sub> = 20 V, 28 V, 40 V I <sub>OUT</sub> = 10%, 50%, 100% rated Note 12	-56	—	56	mV
	15V		-30		30	
	12V		-24		24	
	5V		-10		10	
	3.3V		-10		10	
<b>Load regulation</b>						
(V <sub>RLOAD</sub> )	28V	V <sub>IN</sub> = 20 V, 28 V, 40 V I <sub>OUT</sub> = 10%, 50%, 100% rated Note 11	-280	—	280	mV
	15V		-150		150	
	12V		-120		120	
	5V		-50		50	
	3.3V		-50		50	
<b>Input current</b>						
(I <sub>IN</sub> )	—	I <sub>OUT</sub> =0, pin3 open	—	100	150	mA
		Pin 3 shorted to pin 2	—	2	5	
<b>Output ripple</b>						
(V <sub>RIP</sub> )	28V	V <sub>IN</sub> = 20 V, 28 V, 40 V I <sub>OUT</sub> = 100% rated, Note 4	—	100	280	mV p-p
	15V		—	75	150	
	12V		—	60	120	
	5V		—	25	50	
	3.3V		—	25	50	
<b>Switching frequency</b>						
(FS)	—	Sync input (pin 4) open	200	220	240	kHz
<b>Efficiency</b>						
(EFF)	28V	I <sub>OUT</sub> = 100% rated load	78	82	—	%
	15V		77	82	—	
	12V		76	82	—	
	5V		71	81	—	
	3.3V		62	79	—	

.....continued						
Parameter	Output	Conditions	Min	Nom	Max	Units
<b>Inhibit input</b>						
Inhibit input: ON Threshold	—	Note 1	4.5	—	—	V
Inhibit input: OFF drive current (sink)	—	Note 1	1000	—	—	μA
Inhibit input: OFF Threshold	—	Note 1	—	—	2	V
<b>Current limit point</b>						
(% rated output)	—	When $V_{OUT} = 90\%$ of nominal set point	105	—	145	%
<b>Synchronization</b>						
frequency range	—	The external clock on sync input (pin 4)	500	—	600	kHz
Synchronization pulse-high level	—	Note 1	4.0	—	10.0	V
Synchronization pulse-low level	—	Note 1	-0.5	—	0.5	V
Synchronization pulse-transition rate	—	Note 1	200	—	—	V/μs
Synchronization pulse-duty cycle	—	Note 1	10	—	80	%
<b>Power dissipation, load fault</b>						
(PD)	—	Short circuit, overload Note 6	—	—	24	W
<b>Output response to step load changes</b>						
$(V_{TLD})$	28V	(50% to/from 100%) rated load Note 7	-2200	—	2200	mV peak
	15V		-1200		1200	
	12V		-900		900	
	5V		-500		500	
	3.3V		-300		300	



.....continued						
Parameter	Output	Conditions	Min	Nom	Max	Units
<b>Recovery time, step load changes</b>						
( $T_{TLD}$ )	—	(50% to/from 100%) rated load Notes 7, 8	—	200	2000	$\mu$ s
<b>Output response to step line changes</b>						
(V <sub>TLN</sub> )	28V	20V to/from 40V I <sub>OUT</sub> = 100% rated load Note 9	-1000	—	1000	mV peak
	15V		-600		600	
	12V		-480		480	
	5V		-300		300	
	3.3V		-300		300	
<b>Recovery time, step line changes</b>						
( $T_{TLN}$ )	—	20V to/from 40V I <sub>OUT</sub> = 100% rated load Notes 8, 9	—	200	2000	$\mu$ s
<b>Turn-on response: overshoot</b>						
(V <sub>OS</sub> ) (main)	28V	(0% to 100%) rated load Notes 3, 4, 10	—	—	2800	mV
	15V		—	—	1500	
	12V		—	—	1200	
	5V		—	—	500	
	3.3V		—	—	500	
<b>Turn-on response: turn-on delay</b>						
( $T_{DLY}$ )	—	Note 10	0.1	—	10	ms
<b>Capacitive load</b>						
(CL)	28V	Note 5	—	—	200	$\mu$ F
	15V		—	—	350	
	12V		—	—	450	
	5V		—	—	1000	
	3.3V		—	—	1000	

.....continued

Parameter	Output	Conditions	Min	Nom	Max	Units
<b>Line rejection</b>						
—	—	DC to 50 kHz, I <sub>OUT</sub> = 100% rated load	30	60	—	dB
<b>Isolation</b>						
—	—	50V @25°C 1. Input (1-3) to All (4-12) 2. Sync (4-5) to All (1-3, 6-12) 3. Chassis (6) to All (1-5, 7-12)	100	—	—	MΩ
<b>Mass</b>						
—	—	Standard case style A, B	—	120	—	g
<b>MTBF</b>						
—	—	MIL-HDBK-217F2, SF, 35°C	—	8.22x10 <sup>6</sup>	—	hrs

## 5. Radiation Specification (Note 1)

Environment	Conditions	Min	Unit
TID (gamma)	MIL-STD-883, method 1019 The operating bias applied during exposure	100	krad (Si)
Neutron fluence	MIL-STD-883, 1017	1E12	Neutrons
SEE SEU, SEL, SEGR, SEB	Heavy ions [LET] The operating bias applied during exposure	82	MeV•cm <sup>2</sup> /mg

### Notes:

- Parameter not 100% tested, and only assured by design.
- Parameter verified during line and load regulation tests. Regulation is specified for 10% to 100% loading on all outputs.
- The “-H” option incorporates FET technology providing a >82 MeV•cm<sup>2</sup>/mg (gold ion) SEE capability to the design. The “-P” option is not rated for radiation.
- Tested and verified using a 20 kHz to 10 MHz bandwidth. Ripple is measured across a 50 Ohms termination with a 10 nF Cap in series. Results applicable for DC to 20 MHz bandwidth.
- The capacitive load may be any value from 0 to the maximum limit without compromising DC performance. A capacitive load exceeding the maximum limit may interfere with the proper operation of the converter's overload protection, potentially causing erratic behavior during turn-on.
- Overload power dissipation is defined as the device power dissipation with the load set such that  $V_{OUT} = 90\%$  of nominal.
- The load step transition time is  $\geq 10 \mu\text{s}$ .
- Recovery time is measured from the initiation of the transient to where  $V_{OUT}$  returned to within  $\pm 1\%$  of its steady-state value.
- The line step transition time is  $\geq 100 \mu\text{s}$ .
- Turn-on delay time from either a step application of input power or a logic low to a logic high transition on the inhibit pin (pin 3) to the point where  $V_{OUT} = 90\%$  of nominal.
- Load regulation relative to the output voltage at 50% of nominal-rated load.
- Line regulation relative to the output voltage at 28 VDC input.
- For operation at temperatures between 85°C and 125°C, de-rate power linearly from 50 W (or rated maximum) to zero. Parameter limits are not guaranteed.

## 6. Parallel Operation (Notes)

The output terminals of up to four modules may be connected in parallel. The expected current sharing accuracy is 10% at maximum load. To ensure current sharing, the Parallel terminal of every Power Supply module must be connected to form a common bus. It is recommended that these connections be made relatively short.

The remote sense terminals may remain unconnected. However, for the best output voltage regulation, it is recommended that the remote sense terminal of each of the paralleled set of power supplies be connected to a single point, as close as possible to the positive load terminal or the point where the voltage regulation needs to be maintained. Similarly, it is recommended that the remote sense return terminal of each power supply be connected to a single point, as close as possible to the negative load terminal.

The R-ADJUST function can be used in a system of paralleled modules. The sync function is described in the application notes. The specified sync input signal can be applied to each of the paralleled modules.

For best performance, phase shift the sync signal between modules. The sync functionality remains the same for a system of paralleled modules. The use of the sync function is optional for single and or paralleled operation. The specified sync input signal can be applied to any one of the paralleled modules.

## 7. Sample Electrical Waveforms

Figure 7-1. SA50-28 Efficiency

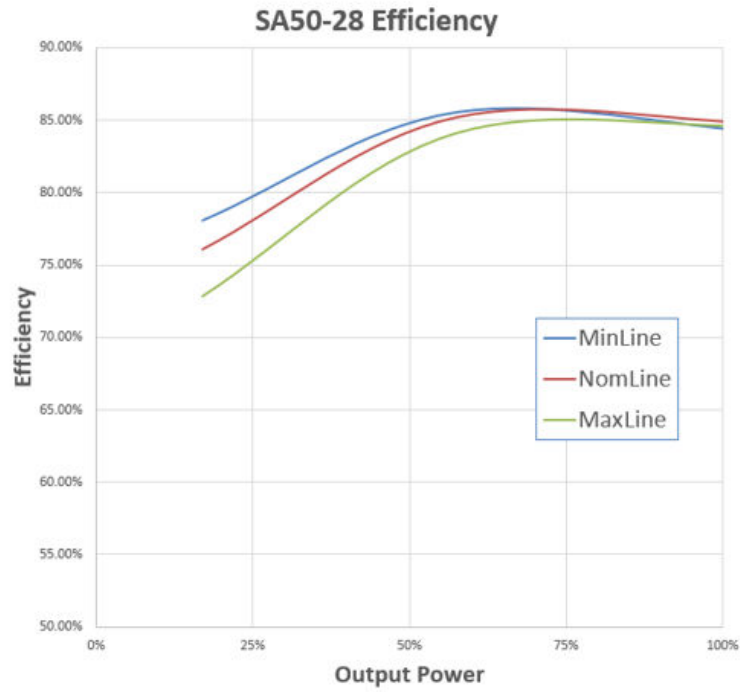

Figure 7-2. SA50-28 EMI

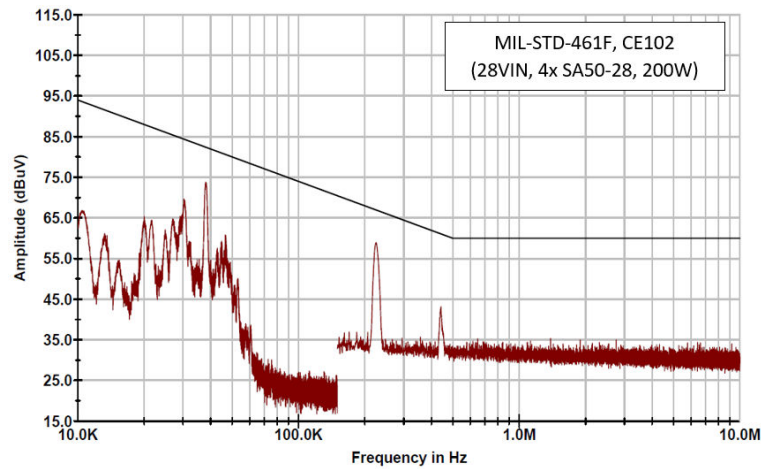

Figure 7-3. Typical Output Ripple

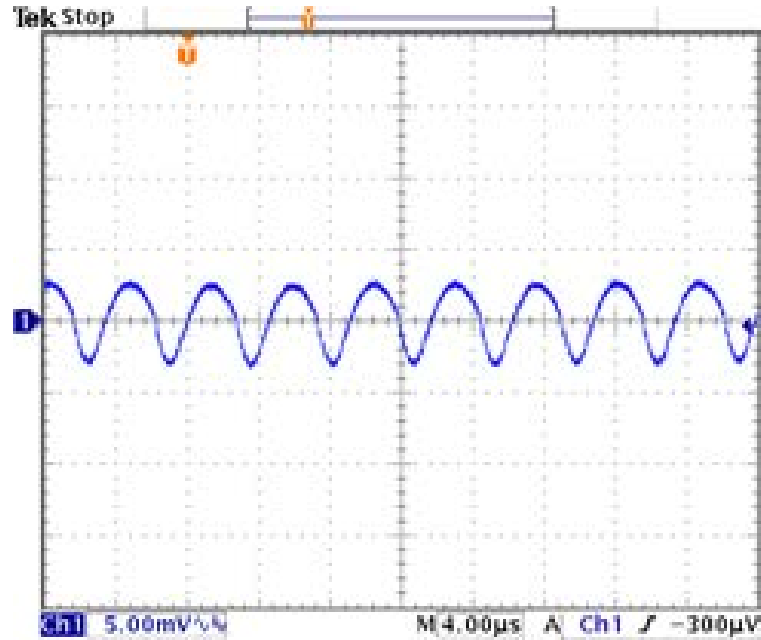
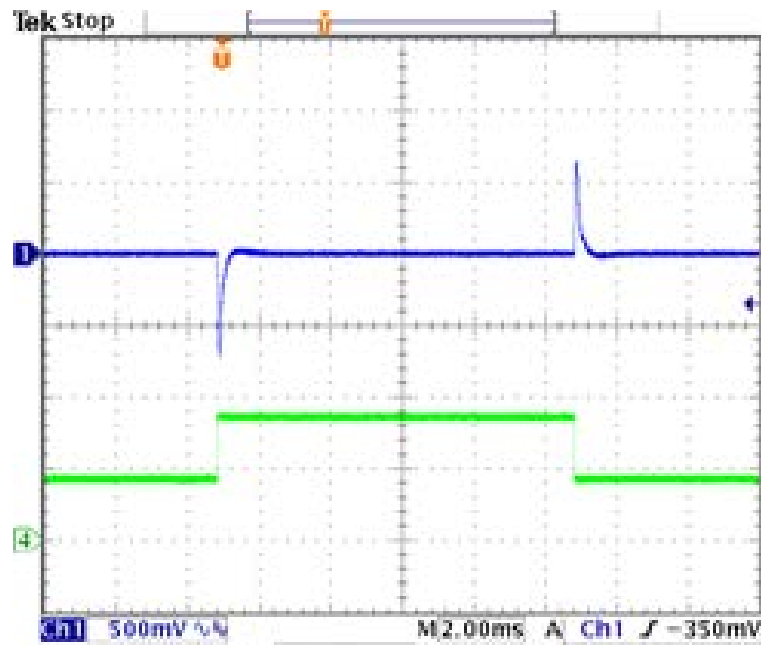

Figure 7-4. Typical 50% Load Step Transient Response



## 8. Pin Configuration

Figure 8-1. SA50-28 Single Pin Configuration



## 9. Pin Description

PIN	NAME	Description
1	VIN	Input Voltage
2	VIN RTN	Input Voltage Return/Ground
3	ON/OFF (INHIBIT)	Power Supply ON/OFF, ON(OPEN/HIGH), OFF(SHORT/LOW)
4	SYNC	External Clock Signal Input
5	SYNC RTN	External Clock Signal Return
6	CHASSIS	Chassis Pin
7	R-ADJUST	Remote Adjust Pin to Adjust Output Voltage
8	PARALLEL	Parallel Bus Pin to use Multiple Devices for Higher Power
9	RMT SNS RTN	Load Voltage Remote Sense Return
10	RMT SNS	Load Voltage Remote Sense
11	VOUT	Output Voltage
12	VOUT RTN	Output Voltage Return/Ground



## 10. Radiation Performance (-H) Hardened

- TID >100 krad (Si) and 30 krad (Si) ELDRS (<10 mrad/s) per MIL-STD-883 Method 1019
- SEE (SEGR, SEB, SET, SEL) immunity 82 MeV·cm<sup>2</sup>/mg (H-hardened)

## 11. Radiation Performance (-P)

Prototype units that are functionally the same. The components are not radiation hardened. To be used for system checkout.



### 13. Mechanical Outline (Radial Pins) Package

Figure 13-1. Radial Pins and Thru-Hole Tabs Package (-D)

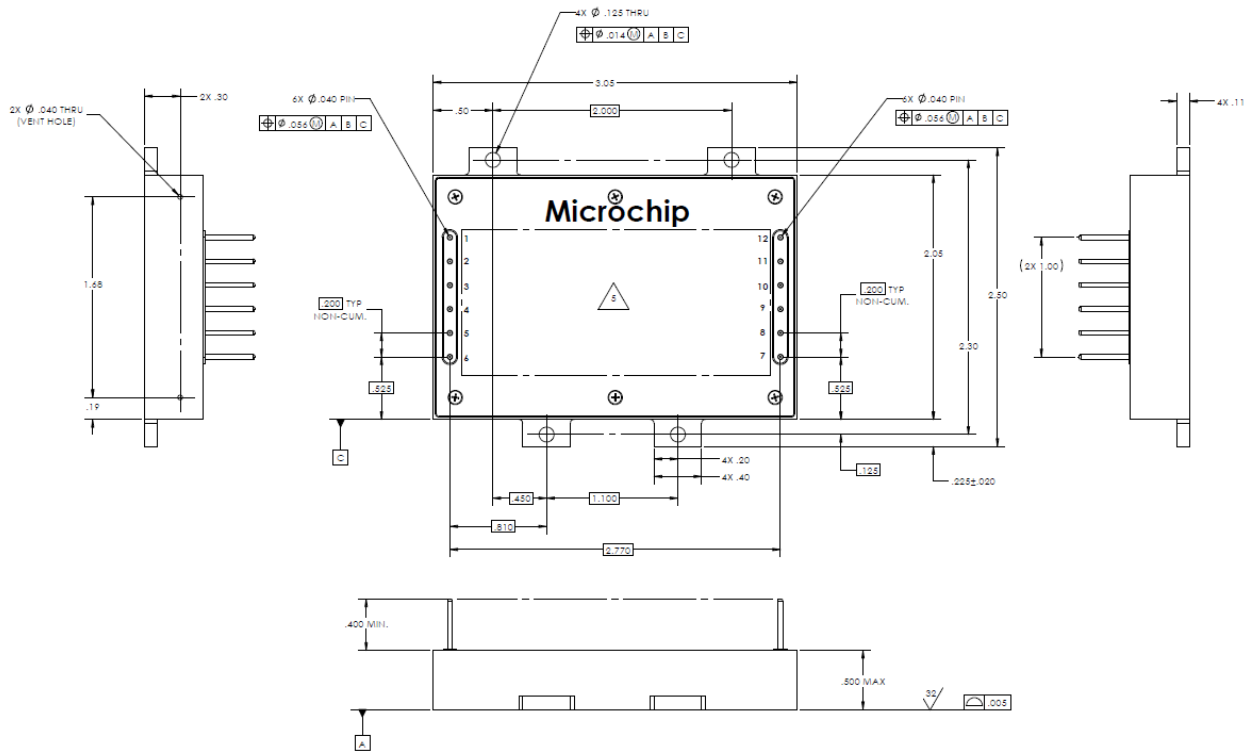
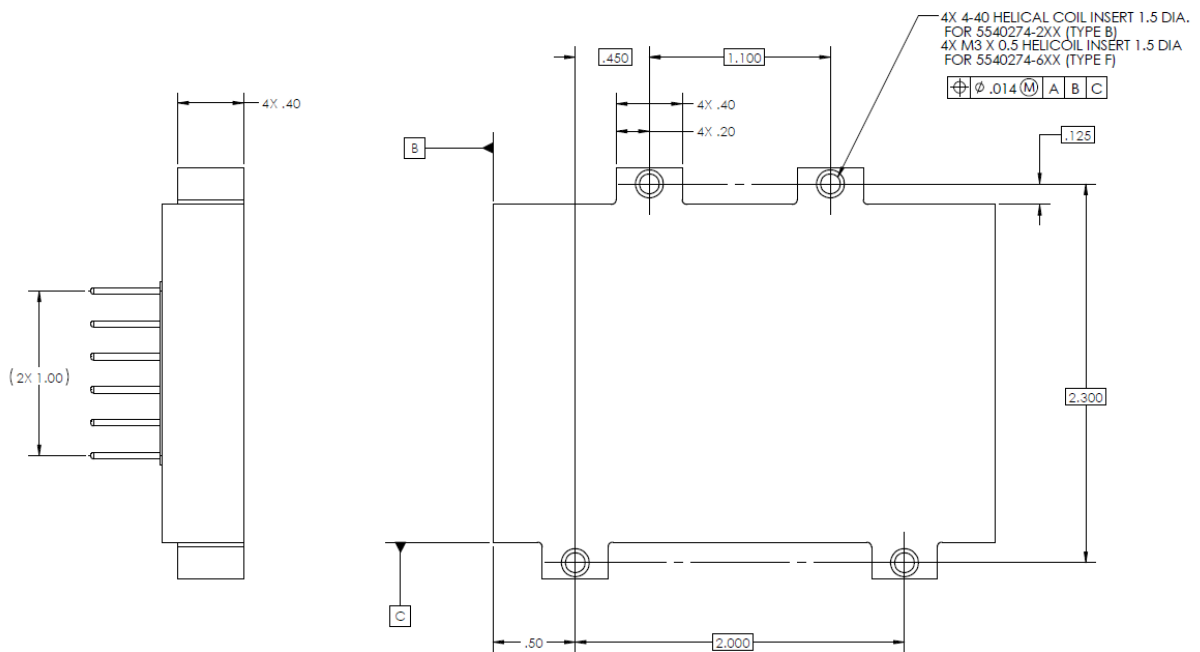

Figure 13-2. Radial Pins and Threaded Tabs Package Bottom View (-B or -F)



## 14. Qualification Test (Reference Report QTR996)

Test	Conditions
External Visual	Per O&M – Dimensions, and mass or STD 883 2009
Electrical	Read and record (-55°C, 25°C, 85°C)
Shock, Non-Operating	MIL-STD-202, method 213, test condition F, 1500 gpk, 0.5 ms ½ sine pulse. Three pulses in each direction of each axis, 18 pulses total.
Vibration, Operating	MIL-STD-202, method 214, condition II-F, 24.06 grms random vibrations, 50 Hz – 2000 Hz, 3 min/axis (9 min total) Outputs monitored.
Temperature Cycling	10 cycles from base plate temperature, MIL-STD-883, method 1010.9, condition A
EMI	CE101, CE102, CS101, RE101, RE102, RS101, RS103 per MIL-STD-461 with setup per MIL-STD-462
External Visual Inspection	No damage
Steady State Life Test	1000 hrs at Tc = 105°C, 50% of rated load
End-Point Electricals	Read and record ( -55°C, 25°C, 85°C)

## 15. ATP Screening Test (-H) Hardened

Requirement	Test Method/Condition
External Visual	O&M - Dimensions and mass
Initial Electrical	Full performance at +25°C
Vibration	Workmanship non-operating vibration MIL-STD-202, Method 214, Condition II-A, 6.21 grms random vibration, 50-2000 Hz, 1-minute perpendicular to the board
Post Vibration Electrical	Full performance at +25°C
Temperature Cycle	MIL-STD-883, Method 1010, Condition A, 1 cycle, +85°C to -55°C, operating. Outputs monitored during thermal cycles
Burn-in	40 hrs @ 105°C, 50% of rated load (outputs monitored)
Final Electrical	Full performance at +25°C (deliverable data)
External Visual	No damage

## 16. ATP Screening Test (-P) Prototypes

Requirement	Test Method/Condition
External Visual	O&M – Dimensions and mass
Electrical	Full performance at +25°C
Vibration	None
Temperature Cycle	None
Burn-in	None
External Visual	No damage

## 17. Ordering Information

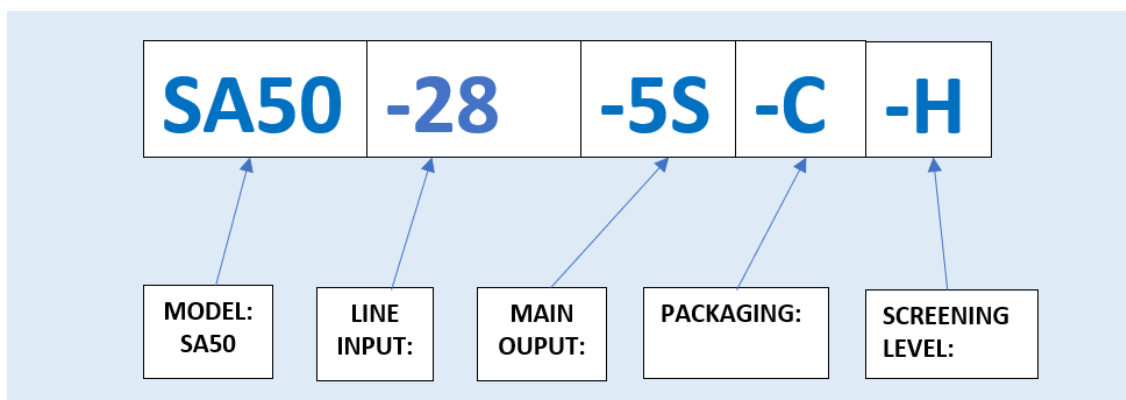

<b>Model</b>	SA50	Standard Applications 50W, 28V input modules.		
<b>Line Input</b>	-28	28.0V	Line input voltage. Nominal input line	
<b>Main</b>	-3R3S	3.3V	Main output voltage	
	-5S	5V		
	-12S	12V		
	-15S	15V		
	-28S	28V		
<b>Mechanical Package</b>	-A	Axial	0.125 in thru-hole	Mechanical packaging options. Electrical connections are either Axial or Radial. Mounting holes are drilled thru-hole or threaded.
	-B	Radial	4-40 thread	
	-C	Axial	M3 thread	
	-D	Radial	0.125 in thru-hole	
	-E	Axial	4-40 thread	
	-F	Radial	M3 thread	
<b>Radiation Hardness</b>	-H	Hardened	We offer units with two levels of radiation screening. Hardened and Prototype (non-hardened) units.	
	-P	Prototype		

**Note:** Other input voltage and output voltage combinations are available. Contact your local sales representative.

Microchip also offers a thermal interface, the ST-2X3; this is a non-silicon, space-approved thermal interface. The data sheet is available upon request.



## 18. Revision History

Revision	Date	Description
E	07/2023	Updates: <ul style="list-style-type: none"><li>• <a href="#">1. Benefits and Features</a> – Updated output power and paralleling identical units</li><li>• <a href="#">2. Typical Application Circuit</a> – Updated identical units</li><li>• <a href="#">3. Absolute Maximum Ratings</a> – Updated output power value</li><li>• <a href="#">4. Electrical Parameters</a> – Updated min and max values for output voltage adjust, output power and output current</li><li>• <a href="#">5. Radiation Specification (Note 1)</a> – Removed deco rate environment</li><li>• <a href="#">6. Parallel Operation (Notes)</a> – Updated number of modules</li><li>• <a href="#">7. Sample Electrical Waveforms</a> – Updated figures</li><li>• <a href="#">9. Pin Description</a> – Updated R-ADJUST description</li><li>• <a href="#">12. Mechanical Outline (Axial Pins) Package</a> – Updated heading and figures</li><li>• <a href="#">13. Mechanical Outline (Radial Pins) Package</a> – Updated heading and figures</li><li>• <a href="#">14. Qualification Test (Reference Report QTR996)</a> – Updated conditions for Shock, non-operating; Vibration, operating and EMI</li><li>• <a href="#">15. ATP Screening Test (-H) Hardened</a> – Updated Vibration test method/condition</li></ul>
D	07/2022	Updated Electrical information in the ATP Screening Test (-P) Prototypes table.
C	04/2022	Updated the Max “Current Limit Point” to 145 in the Electrical Parameters. Updated Figure 13-1.

## Microchip Information

### The Microchip Website

Microchip provides online support via our website at [www.microchip.com/](http://www.microchip.com/). This website is used to make files and information easily available to customers. Some of the content available includes:

- **Product Support** – Data sheets and errata, application notes and sample programs, design resources, user’s guides and hardware support documents, latest software releases and archived software
- **General Technical Support** – Frequently Asked Questions (FAQs), technical support requests, online discussion groups, Microchip design partner program member listing
- **Business of Microchip** – Product selector and ordering guides, latest Microchip press releases, listing of seminars and events, listings of Microchip sales offices, distributors and factory representatives

### Product Change Notification Service

Microchip’s product change notification service helps keep customers current on Microchip products. Subscribers will receive email notification whenever there are changes, updates, revisions or errata related to a specified product family or development tool of interest.

To register, go to [www.microchip.com/pcn](http://www.microchip.com/pcn) and follow the registration instructions.

### Customer Support

Users of Microchip products can receive assistance through several channels:

- Distributor or Representative
- Local Sales Office
- Embedded Solutions Engineer (ESE)
- Technical Support

Customers should contact their distributor, representative or ESE for support. Local sales offices are also available to help customers. A listing of sales offices and locations is included in this document.

Technical support is available through the website at: [www.microchip.com/support](http://www.microchip.com/support)

### Microchip Devices Code Protection Feature

Note the following details of the code protection feature on Microchip products:

- Microchip products meet the specifications contained in their particular Microchip Data Sheet.
- Microchip believes that its family of products is secure when used in the intended manner, within operating specifications, and under normal conditions.
- Microchip values and aggressively protects its intellectual property rights. Attempts to breach the code protection features of Microchip product is strictly prohibited and may violate the Digital Millennium Copyright Act.
- Neither Microchip nor any other semiconductor manufacturer can guarantee the security of its code. Code protection does not mean that we are guaranteeing the product is “unbreakable”. Code protection is constantly evolving. Microchip is committed to continuously improving the code protection features of our products.

### Legal Notice

This publication and the information herein may be used only with Microchip products, including to design, test, and integrate Microchip products with your application. Use of this information in any other manner violates these terms. Information regarding device applications is provided only for your convenience and may be superseded by updates. It is your responsibility to ensure

that your application meets with your specifications. Contact your local Microchip sales office for additional support or, obtain additional support at [www.microchip.com/en-us/support/design-help/client-support-services](http://www.microchip.com/en-us/support/design-help/client-support-services).

THIS INFORMATION IS PROVIDED BY MICROCHIP "AS IS". MICROCHIP MAKES NO REPRESENTATIONS OR WARRANTIES OF ANY KIND WHETHER EXPRESS OR IMPLIED, WRITTEN OR ORAL, STATUTORY OR OTHERWISE, RELATED TO THE INFORMATION INCLUDING BUT NOT LIMITED TO ANY IMPLIED WARRANTIES OF NON-INFRINGEMENT, MERCHANTABILITY, AND FITNESS FOR A PARTICULAR PURPOSE, OR WARRANTIES RELATED TO ITS CONDITION, QUALITY, OR PERFORMANCE.

IN NO EVENT WILL MICROCHIP BE LIABLE FOR ANY INDIRECT, SPECIAL, PUNITIVE, INCIDENTAL, OR CONSEQUENTIAL LOSS, DAMAGE, COST, OR EXPENSE OF ANY KIND WHATSOEVER RELATED TO THE INFORMATION OR ITS USE, HOWEVER CAUSED, EVEN IF MICROCHIP HAS BEEN ADVISED OF THE POSSIBILITY OR THE DAMAGES ARE FORESEEABLE. TO THE FULLEST EXTENT ALLOWED BY LAW, MICROCHIP'S TOTAL LIABILITY ON ALL CLAIMS IN ANY WAY RELATED TO THE INFORMATION OR ITS USE WILL NOT EXCEED THE AMOUNT OF FEES, IF ANY, THAT YOU HAVE PAID DIRECTLY TO MICROCHIP FOR THE INFORMATION.

Use of Microchip devices in life support and/or safety applications is entirely at the buyer's risk, and the buyer agrees to defend, indemnify and hold harmless Microchip from any and all damages, claims, suits, or expenses resulting from such use. No licenses are conveyed, implicitly or otherwise, under any Microchip intellectual property rights unless otherwise stated.

## Trademarks

The Microchip name and logo, the Microchip logo, Adaptec, AVR, AVR logo, AVR Freaks, BesTime, BitCloud, CryptoMemory, CryptoRF, dsPIC, flexPWR, HELDO, IGLOO, JukeBlox, KeeLoq, Kleer, LANCheck, LinkMD, maXStylus, maXTouch, MediaLB, megaAVR, Microsemi, Microsemi logo, MOST, MOST logo, MPLAB, OptoLyzer, PIC, picoPower, PICSTART, PIC32 logo, PolarFire, Prochip Designer, QTouch, SAM-BA, SenGenuity, SpyNIC, SST, SST Logo, SuperFlash, Symmetricom, SyncServer, Tachyon, TimeSource, tinyAVR, UNI/O, Vectron, and XMEGA are registered trademarks of Microchip Technology Incorporated in the U.S.A. and other countries.

AgileSwitch, APT, ClockWorks, The Embedded Control Solutions Company, EtherSynch, Flashtec, Hyper Speed Control, HyperLight Load, Libero, motorBench, mTouch, Powermite 3, Precision Edge, ProASIC, ProASIC Plus, ProASIC Plus logo, Quiet-Wire, SmartFusion, SyncWorld, Temux, TimeCesium, TimeHub, TimePictra, TimeProvider, TrueTime, and ZL are registered trademarks of Microchip Technology Incorporated in the U.S.A.

Adjacent Key Suppression, AKS, Analog-for-the-Digital Age, Any Capacitor, AnyIn, AnyOut, Augmented Switching, BlueSky, BodyCom, Clockstudio, CodeGuard, CryptoAuthentication, CryptoAutomotive, CryptoCompanion, CryptoController, dsPICDEM, dsPICDEM.net, Dynamic Average Matching, DAM, ECAN, Espresso T1S, EtherGREEN, GridTime, IdealBridge, In-Circuit Serial Programming, ICSP, INICnet, Intelligent Paralleling, IntelliMOS, Inter-Chip Connectivity, JitterBlocker, Knob-on-Display, KoD, maxCrypto, maxView, memBrain, Mindi, MiWi, MPASM, MPF, MPLAB Certified logo, MPLIB, MPLINK, MultiTRAK, NetDetach, Omniscient Code Generation, PICDEM, PICDEM.net, PICkit, PICtail, PowerSmart, PureSilicon, QMatrix, REAL ICE, Ripple Blocker, RTAX, RTG4, SAM-ICE, Serial Quad I/O, simpleMAP, SimpliPHY, SmartBuffer, SmartHLS, SMART-I.S., storClad, SQL, SuperSwitcher, SuperSwitcher II, Switchtec, SynchroPHY, Total Endurance, Trusted Time, TSHARC, USBCheck, VariSense, VectorBlox, VeriPHY, ViewSpan, WiperLock, XpressConnect, and ZENA are trademarks of Microchip Technology Incorporated in the U.S.A. and other countries.

SQTP is a service mark of Microchip Technology Incorporated in the U.S.A.

The Adaptec logo, Frequency on Demand, Silicon Storage Technology, and Symmcom are registered trademarks of Microchip Technology Inc. in other countries.

GestIC is a registered trademark of Microchip Technology Germany II GmbH & Co. KG, a subsidiary of Microchip Technology Inc., in other countries.

All other trademarks mentioned herein are property of their respective companies.

© 2022-2023, Microchip Technology Incorporated and its subsidiaries. All Rights Reserved.

ISBN: 978-1-6683-2683-1

## Quality Management System

For information regarding Microchip's Quality Management Systems, please visit [www.microchip.com/quality](http://www.microchip.com/quality).

# Worldwide Sales and Service

AMERICAS	ASIA/PACIFIC	ASIA/PACIFIC	EUROPE
<p><b>Corporate Office</b> 2355 West Chandler Blvd. Chandler, AZ 85224-6199 Tel: 480-792-7200 Fax: 480-792-7277 Technical Support: <a href="http://www.microchip.com/support">www.microchip.com/support</a> Web Address: <a href="http://www.microchip.com">www.microchip.com</a></p> <p><b>Atlanta</b> Duluth, GA Tel: 678-957-9614 Fax: 678-957-1455</p> <p><b>Austin, TX</b> Tel: 512-257-3370</p> <p><b>Boston</b> Westborough, MA Tel: 774-760-0087 Fax: 774-760-0088</p> <p><b>Chicago</b> Itasca, IL Tel: 630-285-0071 Fax: 630-285-0075</p> <p><b>Dallas</b> Addison, TX Tel: 972-818-7423 Fax: 972-818-2924</p> <p><b>Detroit</b> Novi, MI Tel: 248-848-4000</p> <p><b>Houston, TX</b> Tel: 281-894-5983</p> <p><b>Indianapolis</b> Noblesville, IN Tel: 317-773-8323 Fax: 317-773-5453 Tel: 317-536-2380</p> <p><b>Los Angeles</b> Mission Viejo, CA Tel: 949-462-9523 Fax: 949-462-9608 Tel: 951-273-7800</p> <p><b>Raleigh, NC</b> Tel: 919-844-7510</p> <p><b>New York, NY</b> Tel: 631-435-6000</p> <p><b>San Jose, CA</b> Tel: 408-735-9110 Tel: 408-436-4270</p> <p><b>Canada - Toronto</b> Tel: 905-695-1980 Fax: 905-695-2078</p>	<p><b>Australia - Sydney</b> Tel: 61-2-9868-6733</p> <p><b>China - Beijing</b> Tel: 86-10-8569-7000</p> <p><b>China - Chengdu</b> Tel: 86-28-8665-5511</p> <p><b>China - Chongqing</b> Tel: 86-23-8980-9588</p> <p><b>China - Dongguan</b> Tel: 86-769-8702-9880</p> <p><b>China - Guangzhou</b> Tel: 86-20-8755-8029</p> <p><b>China - Hangzhou</b> Tel: 86-571-8792-8115</p> <p><b>China - Hong Kong SAR</b> Tel: 852-2943-5100</p> <p><b>China - Nanjing</b> Tel: 86-25-8473-2460</p> <p><b>China - Qingdao</b> Tel: 86-532-8502-7355</p> <p><b>China - Shanghai</b> Tel: 86-21-3326-8000</p> <p><b>China - Shenyang</b> Tel: 86-24-2334-2829</p> <p><b>China - Shenzhen</b> Tel: 86-755-8864-2200</p> <p><b>China - Suzhou</b> Tel: 86-186-6233-1526</p> <p><b>China - Wuhan</b> Tel: 86-27-5980-5300</p> <p><b>China - Xian</b> Tel: 86-29-8833-7252</p> <p><b>China - Xiamen</b> Tel: 86-592-2388138</p> <p><b>China - Zhuhai</b> Tel: 86-756-3210040</p>	<p><b>India - Bangalore</b> Tel: 91-80-3090-4444</p> <p><b>India - New Delhi</b> Tel: 91-11-4160-8631</p> <p><b>India - Pune</b> Tel: 91-20-4121-0141</p> <p><b>Japan - Osaka</b> Tel: 81-6-6152-7160</p> <p><b>Japan - Tokyo</b> Tel: 81-3-6880-3770</p> <p><b>Korea - Daegu</b> Tel: 82-53-744-4301</p> <p><b>Korea - Seoul</b> Tel: 82-2-554-7200</p> <p><b>Malaysia - Kuala Lumpur</b> Tel: 60-3-7651-7906</p> <p><b>Malaysia - Penang</b> Tel: 60-4-227-8870</p> <p><b>Philippines - Manila</b> Tel: 63-2-634-9065</p> <p><b>Singapore</b> Tel: 65-6334-8870</p> <p><b>Taiwan - Hsin Chu</b> Tel: 886-3-577-8366</p> <p><b>Taiwan - Kaohsiung</b> Tel: 886-7-213-7830</p> <p><b>Taiwan - Taipei</b> Tel: 886-2-2508-8600</p> <p><b>Thailand - Bangkok</b> Tel: 66-2-694-1351</p> <p><b>Vietnam - Ho Chi Minh</b> Tel: 84-28-5448-2100</p>	<p><b>Austria - Wels</b> Tel: 43-7242-2244-39 Fax: 43-7242-2244-393</p> <p><b>Denmark - Copenhagen</b> Tel: 45-4485-5910 Fax: 45-4485-2829</p> <p><b>Finland - Espoo</b> Tel: 358-9-4520-820</p> <p><b>France - Paris</b> Tel: 33-1-69-53-63-20 Fax: 33-1-69-30-90-79</p> <p><b>Germany - Garching</b> Tel: 49-8931-9700</p> <p><b>Germany - Haan</b> Tel: 49-2129-3766400</p> <p><b>Germany - Heilbronn</b> Tel: 49-7131-72400</p> <p><b>Germany - Karlsruhe</b> Tel: 49-721-625370</p> <p><b>Germany - Munich</b> Tel: 49-89-627-144-0 Fax: 49-89-627-144-44</p> <p><b>Germany - Rosenheim</b> Tel: 49-8031-354-560</p> <p><b>Israel - Ra'anana</b> Tel: 972-9-744-7705</p> <p><b>Italy - Milan</b> Tel: 39-0331-742611 Fax: 39-0331-466781</p> <p><b>Italy - Padova</b> Tel: 39-049-7625286</p> <p><b>Netherlands - Drunen</b> Tel: 31-416-690399 Fax: 31-416-690340</p> <p><b>Norway - Trondheim</b> Tel: 47-72884388</p> <p><b>Poland - Warsaw</b> Tel: 48-22-3325737</p> <p><b>Romania - Bucharest</b> Tel: 40-21-407-87-50</p> <p><b>Spain - Madrid</b> Tel: 34-91-708-08-90 Fax: 34-91-708-08-91</p> <p><b>Sweden - Gothenberg</b> Tel: 46-31-704-60-40</p> <p><b>Sweden - Stockholm</b> Tel: 46-8-5090-4654</p> <p><b>UK - Wokingham</b> Tel: 44-118-921-5800 Fax: 44-118-921-5820</p>