

Silicon NPN Phototransistor, RoHS Compliant

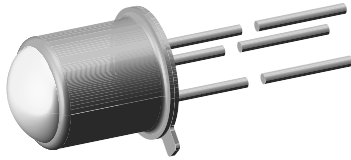

94 8401

DESCRIPTION

BPW77 is a silicon NPN phototransistor with high radiant sensitivity in hermetically sealed TO-18 package with base terminal and glass lens. It is sensitive to visible and near infrared radiation.

FEATURES

- Package type: leaded
- Package form: TO-18
- Dimensions (in mm): \varnothing 4.7
- High photo sensitivity
- High radiant sensitivity
- Suitable for visible and near infrared radiation
- Fast response times
- Angle of half sensitivity: $\varphi = \pm 10^\circ$
- Base terminal connected
- Hermetically sealed package
- Lead (Pb)-free component in accordance with RoHS 2002/95/EC and WEEE 2002/96/EC



RoHS
COMPLIANT

APPLICATIONS

- Detector in electronic control and drive circuits

| PRODUCT SUMMARY | | | |
|-----------------|---------------|-----------------|----------------------|
| COMPONENT | I_{ca} (mA) | φ (deg) | $\lambda_{0.1}$ (nm) |
| BPW77NA | 7.5 to 15 | ± 10 | 450 to 1080 |
| BPW77NB | > 10 | ± 10 | 450 to 1080 |

Note

Test condition see table "Basic Characteristics"

| ORDERING INFORMATION | | | |
|----------------------|-----------|------------------------------|--------------|
| ORDERING CODE | PACKAGING | REMARKS | PACKAGE FORM |
| BPW77NA | Bulk | MOQ: 1000 pcs, 1000 pcs/bulk | TO-18 |
| BPW77NB | Bulk | MOQ: 1000 pcs, 1000 pcs/bulk | TO-18 |

Note

MOQ: minimum order quantity

| ABSOLUTE MAXIMUM RATINGS | | | | |
|-------------------------------------|--|------------|---------------|------|
| PARAMETER | TEST CONDITION | SYMBOL | VALUE | UNIT |
| Collector base voltage | | V_{CBO} | 80 | V |
| Collector emitter voltage | | V_{CEO} | 70 | V |
| Emitter base voltage | | V_{EBO} | 5 | V |
| Collector current | | I_C | 50 | mA |
| Collector peak current | $t_p/T = 0.5, t_p \leq 10$ ms | I_{CM} | 100 | mA |
| Total power dissipation | $T_{amb} \leq 25$ °C | P_V | 250 | mW |
| Junction temperature | | T_j | 125 | °C |
| Operating temperature range | | T_{amb} | - 40 to + 125 | °C |
| Storage temperature range | | T_{stg} | - 40 to + 125 | °C |
| Soldering temperature | $t \leq 5$ s | T_{sd} | 260 | °C |
| Thermal resistance junction/ambient | Connected with Cu wire, 0.14 mm ² | R_{thJA} | 400 | K/W |
| Thermal resistance junction/gase | | R_{thJC} | 150 | K/W |

Note

$T_{amb} = 25$ °C, unless otherwise specified

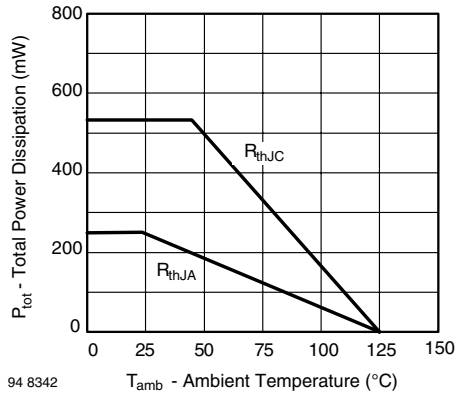

Fig. 1 - Power Dissipation Limit vs. Ambient Temperature

| BASIC CHARACTERISTICS | | | | | | |
|--------------------------------------|---|-----------------|------|-------------|------|---------------|
| PARAMETER | TEST CONDITION | SYMBOL | MIN. | TYP. | MAX. | UNIT |
| Collector emitter breakdown voltage | $I_C = 1 \text{ mA}$ | $V_{(BR)CEO}$ | 70 | | | V |
| Collector emitter dark current | $V_{CE} = 20 \text{ V}, E = 0$ | I_{CEO} | | 1 | 100 | nA |
| Collector emitter capacitance | $V_{CE} = 5 \text{ V}, f = 1 \text{ MHz}, E = 0$ | C_{CEO} | | 6 | | pF |
| Angle of half sensitivity | | ϕ | | ± 10 | | deg |
| Wavelength of peak sensitivity | | λ_p | | 850 | | nm |
| Range of spectral bandwidth | | $\lambda_{0.1}$ | | 450 to 1080 | | nm |
| Collector emitter saturation voltage | $E_e = 1 \text{ mW/cm}^2, \lambda = 950 \text{ nm}, I_C = 1 \text{ mA}$ | V_{CEsat} | | 0.15 | 0.3 | V |
| Turn-on time | $V_S = 5 \text{ V}, I_C = 5 \text{ mA}, R_L = 100 \Omega$ | t_{on} | | 6 | | μs |
| Turn-off time | $V_S = 5 \text{ V}, I_C = 5 \text{ mA}, R_L = 100 \Omega$ | t_{off} | | 5 | | μs |
| Cut-off frequency | $V_S = 5 \text{ V}, I_C = 5 \text{ mA}, R_L = 100 \Omega$ | f_c | | 110 | | kHz |

Note

$T_{amb} = 25 \text{ }^\circ\text{C}$, unless otherwise specified

| TYPE DEDICATED CHARACTERISTICS | | | | | | | |
|--------------------------------|---|---------|----------|------|------|------|------|
| PARAMETER | TEST CONDITION | PART | SYMBOL | MIN. | TYP. | MAX. | UNIT |
| Collector light current | $E_e = 1 \text{ mW/cm}^2, \lambda = 950 \text{ nm}, V_{CE} = 5 \text{ V}$ | BPW77NA | I_{ca} | 7.5 | | 15 | mA |
| | | BPW77NB | I_{ca} | 10 | | | mA |

BASIC CHARACTERISTICS

$T_{amb} = 25 \text{ }^\circ\text{C}$, unless otherwise specified

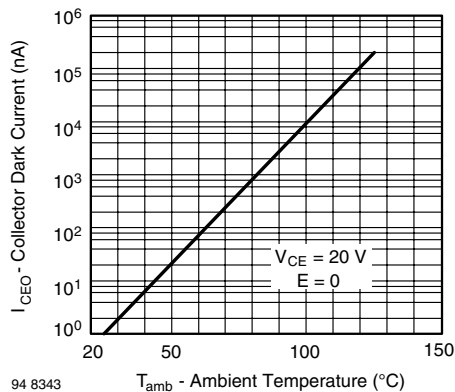

Fig. 2 - Collector Dark Current vs. Ambient Temperature

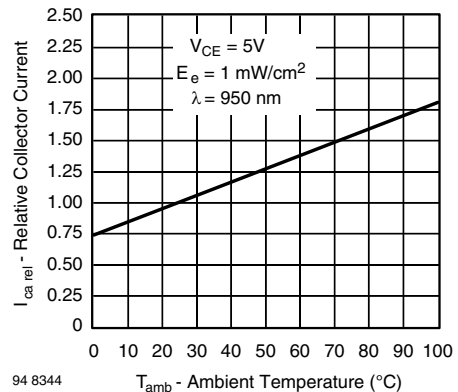

Fig. 3 - Relative Collector Current vs. Ambient Temperature

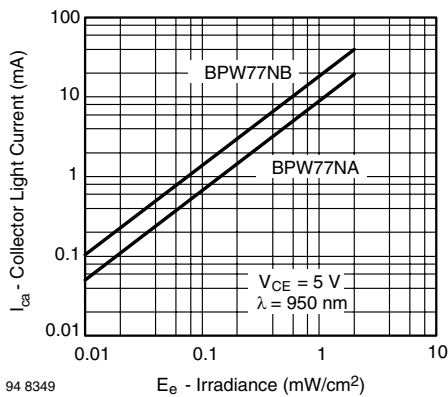

Fig. 4 - Collector Light Current vs. Irradiance

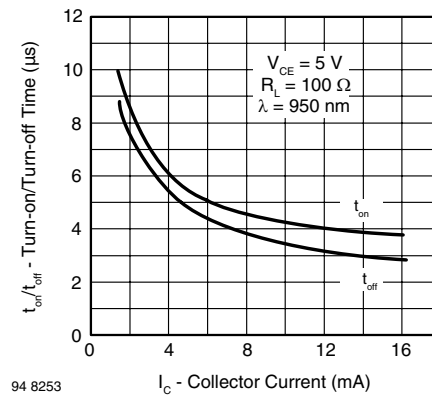

Fig. 7 - Turn-on/Turn-off Time vs. Collector Current

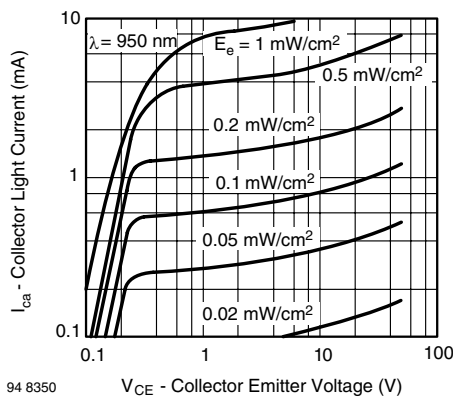

Fig. 5 - Collector Light Current vs. Collector Emitter Voltage

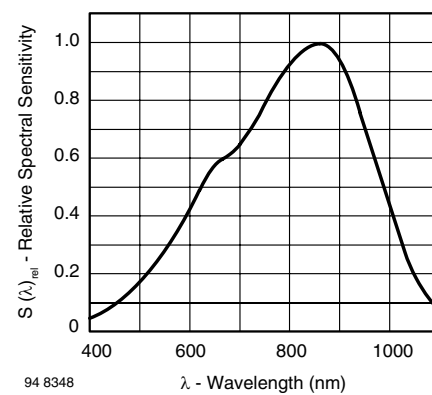

Fig. 8 - Relative Spectral Sensitivity vs. Wavelength

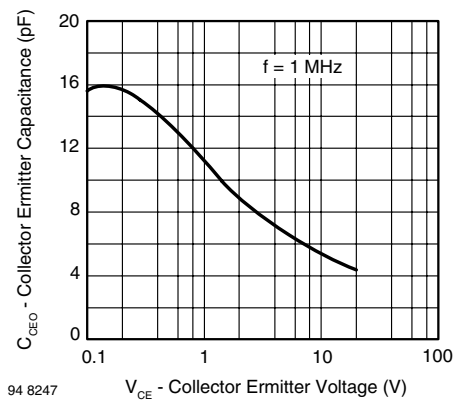

Fig. 6 - Collector Emitter Capacitance vs. Collector Emitter Voltage

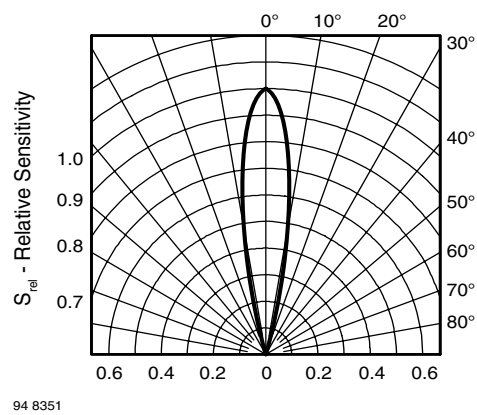

Fig. 9 - Relative Radiant Sensitivity vs. Angular Displacement



BPW77NA, BPW77NB

Silicon NPN Phototransistor, RoHS Compliant Vishay Semiconductors

PACKAGE DIMENSIONS in millimeters

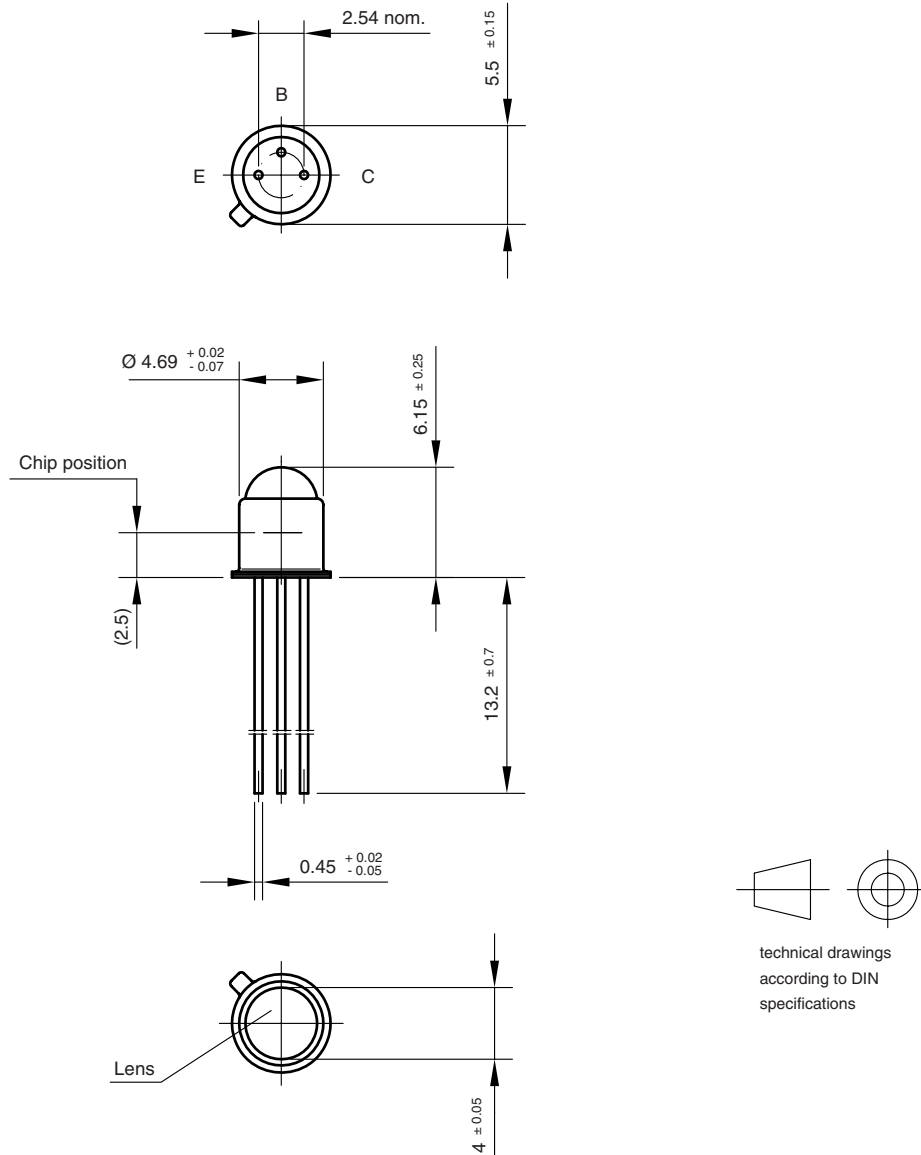

Drawing-No.: 6.503-5023.01-4
Issue: 1; 01.07.96
96 12180



Disclaimer

ALL PRODUCT, PRODUCT SPECIFICATIONS AND DATA ARE SUBJECT TO CHANGE WITHOUT NOTICE TO IMPROVE RELIABILITY, FUNCTION OR DESIGN OR OTHERWISE.

Vishay Intertechnology, Inc., its affiliates, agents, and employees, and all persons acting on its or their behalf (collectively, "Vishay"), disclaim any and all liability for any errors, inaccuracies or incompleteness contained in any datasheet or in any other disclosure relating to any product.

Vishay makes no warranty, representation or guarantee regarding the suitability of the products for any particular purpose or the continuing production of any product. To the maximum extent permitted by applicable law, Vishay disclaims (i) any and all liability arising out of the application or use of any product, (ii) any and all liability, including without limitation special, consequential or incidental damages, and (iii) any and all implied warranties, including warranties of fitness for particular purpose, non-infringement and merchantability.

Statements regarding the suitability of products for certain types of applications are based on Vishay's knowledge of typical requirements that are often placed on Vishay products in generic applications. Such statements are not binding statements about the suitability of products for a particular application. It is the customer's responsibility to validate that a particular product with the properties described in the product specification is suitable for use in a particular application. Parameters provided in datasheets and / or specifications may vary in different applications and performance may vary over time. All operating parameters, including typical parameters, must be validated for each customer application by the customer's technical experts. Product specifications do not expand or otherwise modify Vishay's terms and conditions of purchase, including but not limited to the warranty expressed therein.

Hyperlinks included in this datasheet may direct users to third-party websites. These links are provided as a convenience and for informational purposes only. Inclusion of these hyperlinks does not constitute an endorsement or an approval by Vishay of any of the products, services or opinions of the corporation, organization or individual associated with the third-party website. Vishay disclaims any and all liability and bears no responsibility for the accuracy, legality or content of the third-party website or for that of subsequent links.

Except as expressly indicated in writing, Vishay products are not designed for use in medical, life-saving, or life-sustaining applications or for any other application in which the failure of the Vishay product could result in personal injury or death. Customers using or selling Vishay products not expressly indicated for use in such applications do so at their own risk. Please contact authorized Vishay personnel to obtain written terms and conditions regarding products designed for such applications.

No license, express or implied, by estoppel or otherwise, to any intellectual property rights is granted by this document or by any conduct of Vishay. Product names and markings noted herein may be trademarks of their respective owners.