

### DESCRIPTION

The EVQ2013-J\_Q\_G-00A is an evaluation board for the MPQ2013, a low linear regulator that supplies power to systems with high voltage batteries.

MPQ2013 includes a wide 2.5V to 40V input range, low dropout voltage and low quiescent supply current. The low quiescent current and low dropout voltage allow operations at extremely low power levels. Therefore, the MPQ2013 are ideal for the low power microcontrollers and the battery-powered equipments.

The EVQ2013-J\_Q\_G-00A is a fully assembled and tested evaluation board. It generates a +5V output voltage at load current up to 150mA from a 6V to 40V input range.

### ELECTRICAL SPECIFICATIONS

Parameter	Symbol	Value	Units
Input Voltage	$V_{IN}$	6 – 40	V
Output Voltage	$V_{OUT}$	5	V
Output Current	$I_{OUT}$	150	mA

### FEATURES

- 6V to 40V Input Range
- 3.2µA Quiescent Supply Current
- 150mA specified current
- 620mV Dropout at 150mA Load
- Output ±2% Accuracy
- Specified current limit
- Thermal Shutdown
- -40°C to +125°C Specified Junction Temperature Range
- Includes all three packages TSOT23-5, QFN6 (2x2mm), or QFN8 (3x3mm) Packages

### APPLICATIONS

- Industrial/Automotive Applications
- Portable/Battery-Powered Equipment
- Ultra low power Microcontrollers
- Cellular Handsets
- Medical Imaging

All MPS parts are lead-free and adhere to the RoHS directive. For MPS green status, please visit MPS website under Quality Assurance. "MPS" and "The Future of Analog IC Technology" are Registered Trademarks of Monolithic Power Systems, Inc.

### EVQ2013-J\_Q\_G-00A EVALUATION BOARD



(L x W x H) 2.5" x 2.5" x 0.4"  
(6.4cm x 6.4cm x 1.0cm)

Board Number	MPS IC Number
EVQ2013-J_Q_G-00A	MPQ2013-GJ/GQ/GG

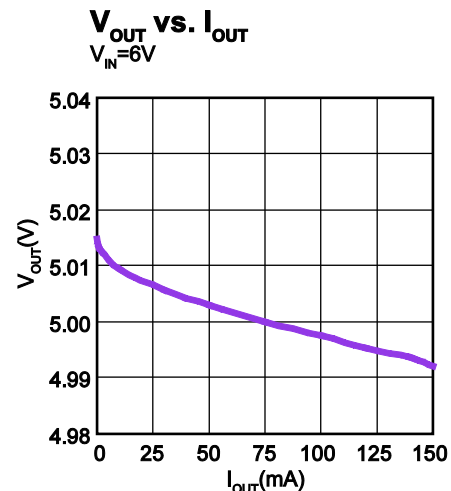

## EVALUATION BOARD SCHEMATIC

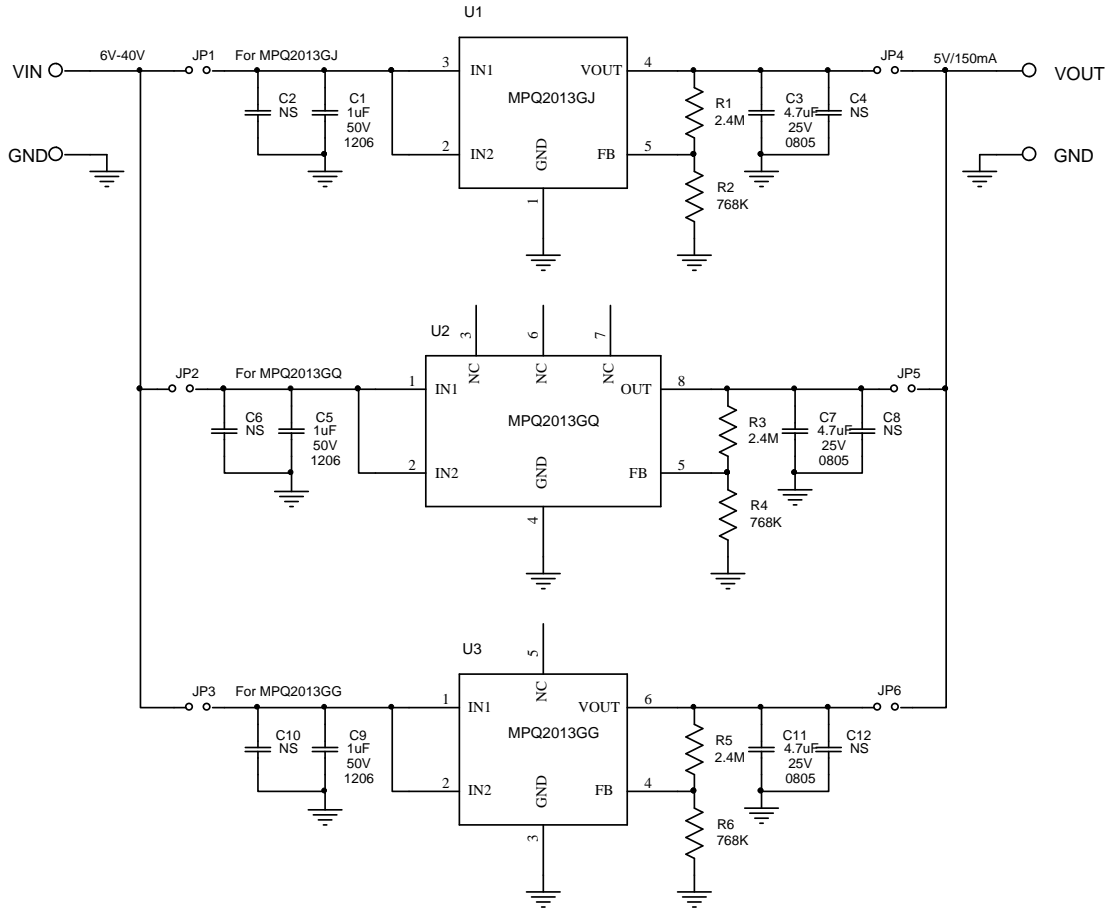

## EVQ2013-J\_Q\_G-00A BILL OF MATERIALS

Qty	RefDes	Value	Description	Package	Manufacturer	Manufacturer_P/N
3	C1, C5, C9	1 $\mu$ F	Ceramic Cap., 50V, X7R	1206	muRata	GRM31MR71H105KA88L
3	C3, C7, C11	4.7 $\mu$ F	Ceramic Cap., 25V, X5R	0805	muRata	GRM21BR61E475KA12L
6	C2, C4, C6, C8, C10, C12	NS				
3	R1, R3, R5	2.4M	Film Res., 1%	0603	Yageo	RC0603FR-072M4L
3	R2, R4, R6	768k	Film Res., 1%	0603	Yageo	RC0603FR-07768KL
6	JP1, JP2, JP, JP4, JP5, JP6		Jumper			
1	U1	MPQ2013GJ		TSOT23-5	MPS	MPQ2013GJ
1	U2	MPQ2013GQ		QFN8-3x3	MPS	MPQ2013GQ
1	U3	MPQ2013GG		QFN6-2x2	MPS	MPQ2013GG

## EVB TEST RESULTS

Performance waveforms are tested on the evaluation board.

$V_{OUT} = 5V$ ,  $T_A = 25^\circ C$ , unless otherwise noted.

**Ground Current vs. Load Current**  
 $V_{IN} = 6V$

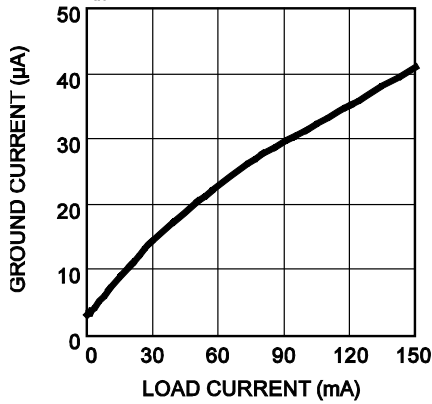

**Ground Current vs.  $V_{IN}$**   
 $I_o = 0mA$

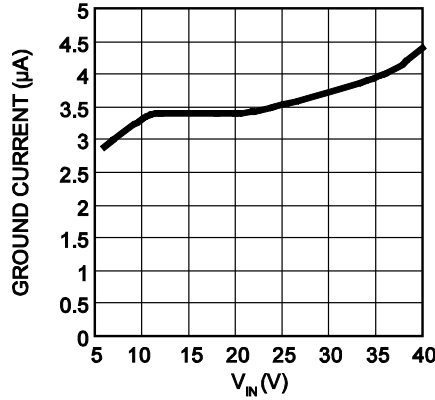

**Dropout Voltage vs. Load Current**

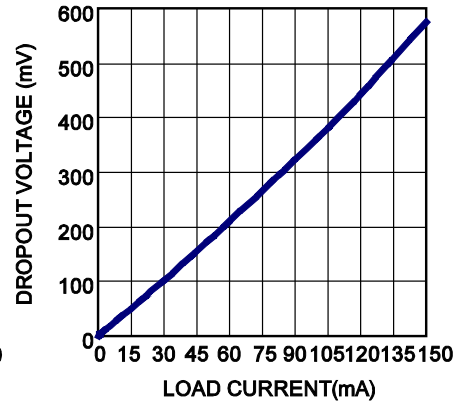

**$V_{OUT}$  vs.  $I_{OUT}$**   
 $V_{IN} = 6V$

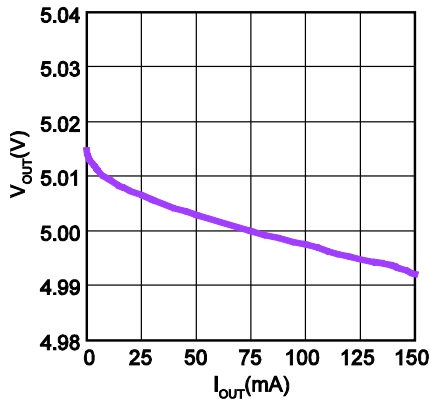

**$V_{OUT}$  vs.  $V_{IN}$**   
 $V_o = 5V$

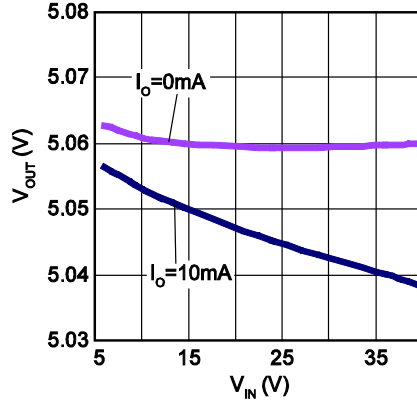

**PSRR vs. Frequency**

$V_{IN1} = V_{IN2} = 6V$ ,  $I_o = 10mA$ ,  $C_{IN} = 100pF$

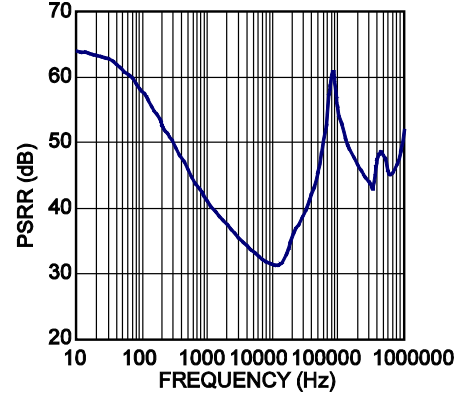

## EVB TEST RESULTS *(continued)*

Performance waveforms are tested on the evaluation board.

$V_{OUT} = 5V$ ,  $T_A = 25^\circ C$ , unless otherwise noted.

### Load Transient

$V_{IN} = 12V$ ,  $I_{OUT} = 8mA-150mA$

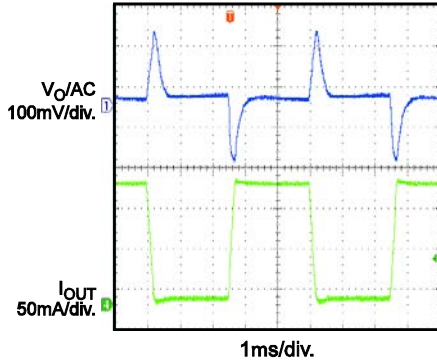

### Line Transient

$V_{IN} = 6V-7V$ ,  $I_{OUT} = 150mA$

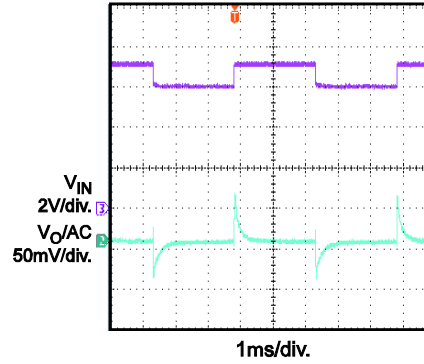

### Startup Through $V_{IN}$

$V_{IN} = 12V$ ,  $I_{OUT} = 150mA$

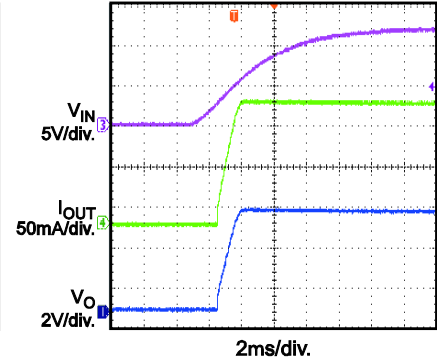

### Shutdown Through $V_{IN}$

$V_{IN} = 12V$ ,  $I_{OUT} = 150mA$

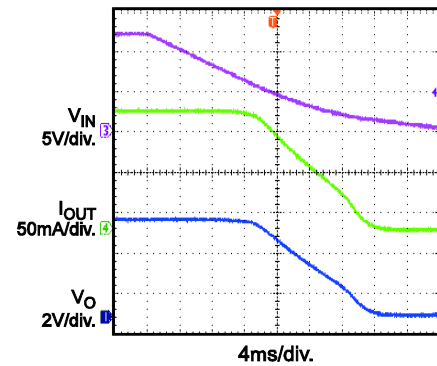

### Short Circuit Entry

$V_{IN} = 12V$ ,  $I_{OUT} = 0mA$  to short circuit

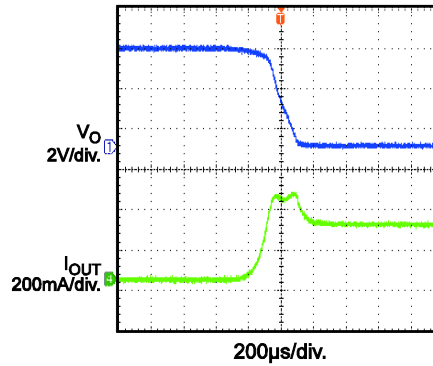

### Short Circuit Recovery

$V_{IN} = 12V$ , short circuit to  $I_{OUT} = 0mA$

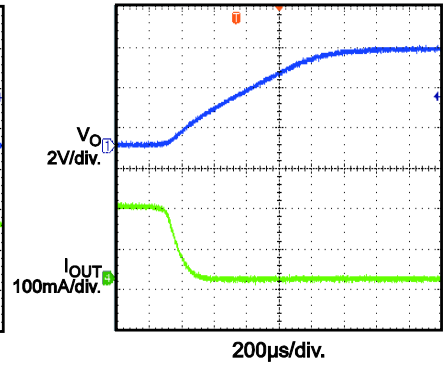

### Short Circuit Steady State

$V_{IN} = 12V$

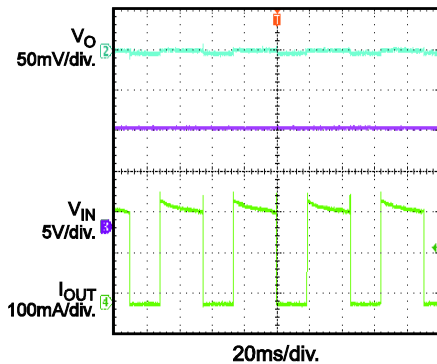

### PRINTED CIRCUIT BOARD LAYOUT

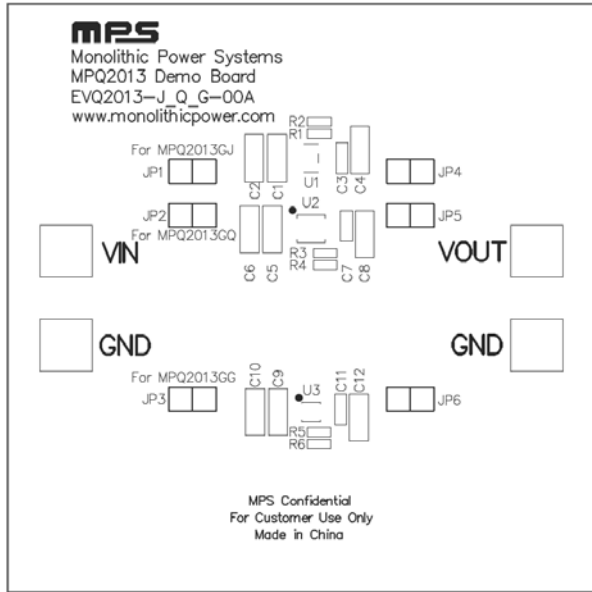

Figure 1—Top Silk Layer

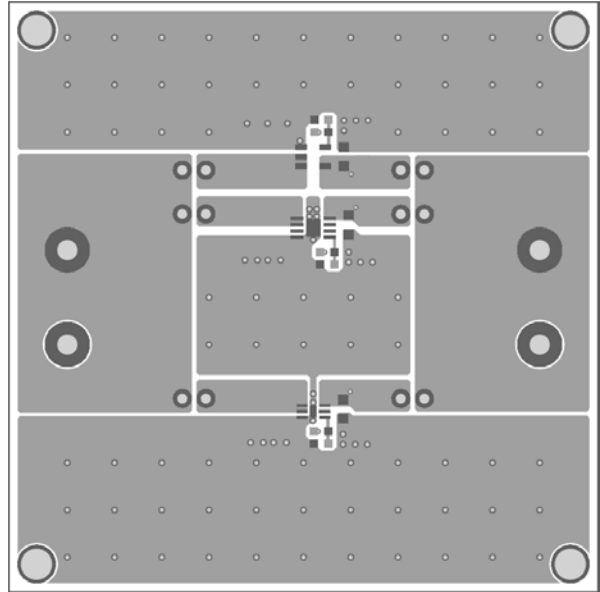

Figure 2—Top Layer

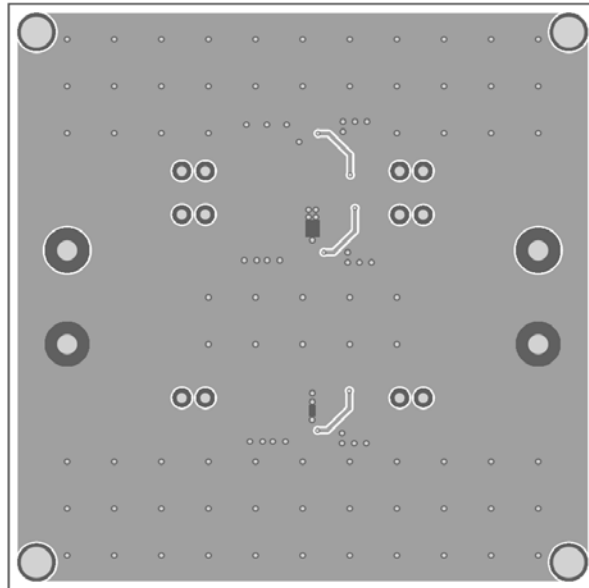

Figure 3—Bottom Layer

## QUICK START GUIDE

1. Connect different jumpers to select different MPQ2013 ICs with different packages for evaluation:

Connected Jumpers	Selected IC
JP1, JP4	MPQ2013GJ
JP2, JP5	MPQ2013GQ
JP3, JP6	MPQ2013GG

2. Connect the positive and negative terminals of the load to the VOUT and GND pins, respectively.
3. Preset the power supply output between 6 and 40V, and then turn it off.
4. Connect the positive and negative terminals of the power supply output to the VIN and GND pins, respectively.
5. Turn the power supply on. The MPQ2013 will automatically startup.
6. To lower the additional current dissipation, resistors of FB divider on the demo board are chosen to high value. If part would performance no load when  $T_a > 85^\circ\text{C}$ , FB dividers should be lower to maintain a minimum load to draw the leakage current from OUT pin. The recommended maxim value of R2/R4/R6 is 506k when  $T_a \leq 105^\circ\text{C}$  and 173k when  $T_a \leq 125^\circ\text{C}$ . Once R2/R4/R6 is determined, R1/R3/R5 can be calculated by below formula (take R1 as an example):

$$R1 = R2 \times \left( \frac{V_{\text{OUT}}}{1.215\text{V}} - 1 \right)$$

**NOTICE:** The information in this document is subject to change without notice. Users should warrant and guarantee that third party Intellectual Property rights are not infringed upon when integrating MPS products into any application. MPS will not assume any legal responsibility for any said applications.