

FAN6250M6X

Secondary Side Synchronous Rectifier Controller for Flyback Converters

Description

The FAN6250M6X is a secondary-side synchronous rectifier (SR) controller for an isolated flyback converter operating in Discontinuous Conduction Mode (DCM). The adaptive dead time control algorithm minimizes the body diode conduction of SR MOSFET while guaranteeing stable and robust SR operation against noise and disturbance caused by the circuit parasitic.

Programmable thermal Shut-Down (SD) function that is informing primary side controller to shut-down the power system when pairing with PSR controller – FAN1080. The Dynamic Response Enhancement (DRE) function that minimizes system response time when pairing with PSR controller – FAN1080.

Features

- Works in Discontinuous Conduction Modes (DCM) and Boundary Conduction Modes (BCM)
- Adaptive Turn-off Trigger Blanking Time for Wide SR MOSFET Application
- Gate Turn-on Blanking Time (minimum Gate OFF Time)
- Dynamic Response Enhancement (DRE) Function that minimizes System Response Time
- Programmable Shut-Down (SD) Protection
- Minimum Turn-on Delay (20 ns)
- Input Voltage (VIN) Range for LDO Input: 3.25 V to 20 V
- Fewest External Components Allowed
- Accurate Turn Off Dead Time Regulation when working with PSR Power System
- Small Footprint: SOT-23 6 Pin
- This is a Pb-Free Device

Typical Applications

- Travel Adapter for Smart Phones, Feature Phones, and Tablet PCs
- AC-DC Adapters for Portable Devices that Require CV/CC Control

ORDERING INFORMATION

Part Number	Operating Temperature	Package	Packing Method†
FAN6250M6X	-40°C to 125°C	6 Lead, SOT23 (Pb-Free)	3000 / Tape & Reel

†For information on tape and reel specifications, including part orientation and tape sizes, please refer to our Tape and Reel Packaging Specifications Brochure, BRD8011/D



ON Semiconductor®

www.onsemi.com



SOT-23, 6 Lead
CASE 527AJ

MARKING DIAGRAM

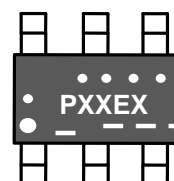

... = Year Code
PXX = 250 : FAN6250
E X = Die Run Code
— = Date Code

PIN CONNECTIONS

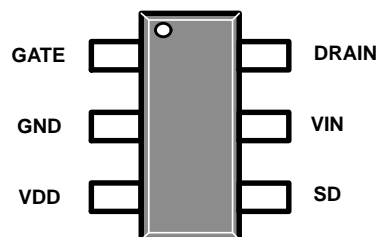

FAN6250M6X

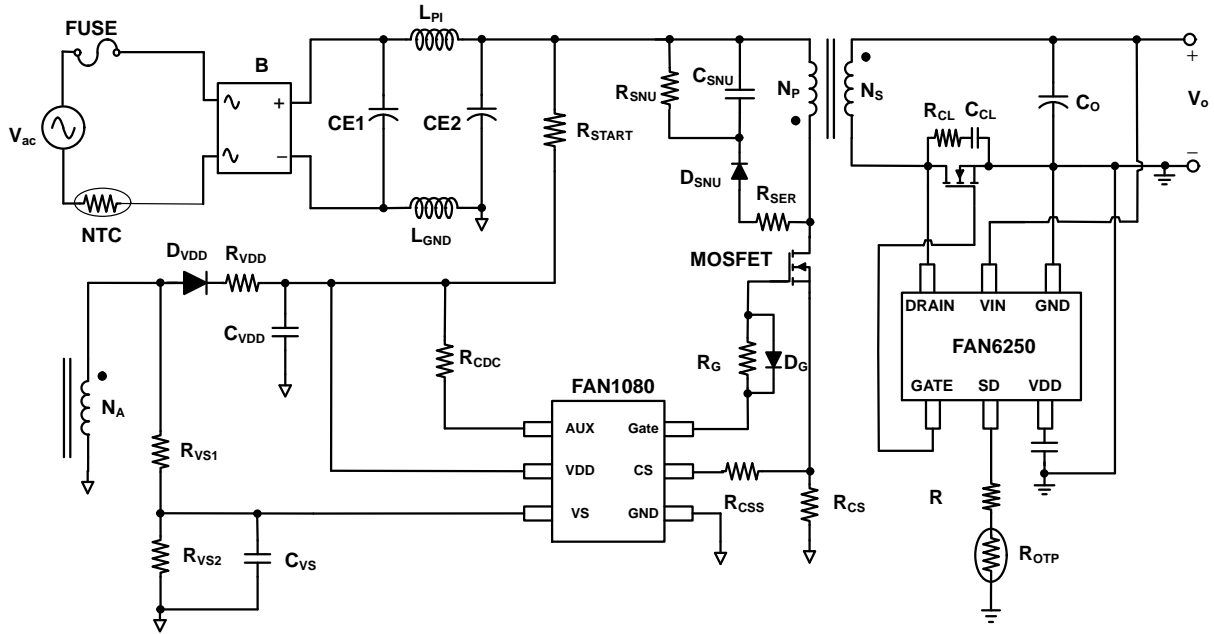

Figure 1. FAN6250 Typical Application Schematic

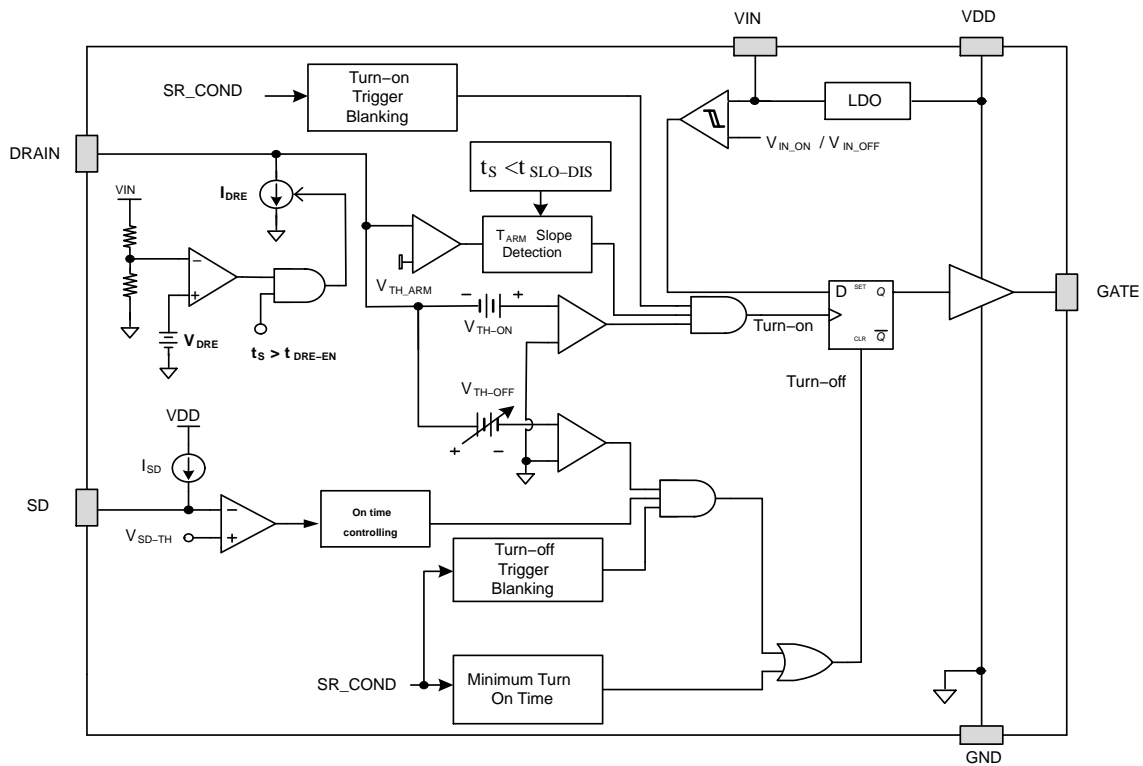

Figure 2. FAN6250 Function Block Diagram

FAN6250M6X

Table 1. PIN FUNCTION DESCRIPTION

Pin #	Name	Description
1	GATE	Gate drive output
2	GND	Ground
3	VDD	Internal regulator 5 V output and gate drive power supply. Bypass with a 1 uF capacitor to GND.
4	SD	Shut-Down pin. This pin is implemented for external over-temperature-protect by connecting the NTC thermistor.
5	VIN	Input Voltage Pin. This pin is connected to the output of the adaptor to monitor its output voltage and supply internal bias. IC operating current and MOSFET gate drive current is supplied through this pin.
6	DRAIN	Synchronous rectifier drain sense input.

Table 2. ABSOLUTE MAXIMUM RATINGS (Notes 1, 2, 3)

Parameter	Symbol	Value	Unit	
Power Supply Input Pin Voltage	V_{IN}	-0.3 to 20	V	
Internal Regulator Output Pin Voltage	V_{DD}	-0.3 to 6.5	V	
Drain Sense Input Pin Voltage	V_{DRAIN}	-1 to 65	V	
Gate Drive Output Pin Voltage	V_{GATE}	-0.3 to 6.5	V	
Shut-Down Pin Voltage	V_{SD}	-0.3 to 6.5	V	
Sense Pin Voltage	V_{SNS}	-0.3 to 6.5	V	
Power Dissipation ($T_A = 25^\circ\text{C}$)	P_D	0.446	W	
Operating Junction Temperature	T_J	-40 to 125	$^\circ\text{C}$	
Storage Temperature Range	T_{STG}	-60 to 150	$^\circ\text{C}$	
Lead Temperature (Soldering) 10 Seconds	T_L	260	$^\circ\text{C}$	
Electrostatic Discharge Capability	Charged Device Model (CDM)	ESD	> 0.5	kV
	Human Body Model (HBM)		> 2	

Stresses exceeding those listed in the Maximum Ratings table may damage the device. If any of these limits are exceeded, device functionality should not be assumed, damage may occur and reliability may be affected.

1. All voltage values, except differential voltages, are given with respect to the GND pin.
2. Stresses beyond those listed under Absolute Maximum Ratings may cause permanent damage to the device.
3. Meets JEDEC standards JS-001-2012 and JESD 22-C101.

Table 3. THERMAL CHARACTERISTICS ($T_A = 25^\circ\text{C}$ unless otherwise specified)

Parameter	Symbol	Min	Unit
Junction-to-Ambient Thermal Impedance	θ_{JA}	218.2	$^\circ\text{C}/\text{W}$
Junction-to-Top Thermal Impedance	θ_{JT}	31.3	$^\circ\text{C}/\text{W}$

Table 4. RECOMMENDED OPERATING RANGES

Parameter	Symbol	Min	Max	Unit
Drain Pin Voltage	V_{DRAIN}		60	V
VDD Pin Voltage	V_{DD}	3.1	5.5	V
VIN Pin Voltage	V_{IN}	3.25	20	V

Functional operation above the stresses listed in the Recommended Operating Ranges is not implied. Extended exposure to stresses beyond the Recommended Operating Ranges limits may affect device reliability.

FAN6250M6X

Table 5. ELECTRICAL CHARACTERISTICS

$V_{IN} = 5.5\text{ V}$ and $T_A = -40$ to 125°C unless noted otherwise

Parameter	Test Conditions	Symbol	Min	Typ	Max	Unit
VDD Section						
Turn-On Threshold	V_{IN} rising	V_{IN-ON}	3.06	3.15	3.25	V
Turn-Off Threshold	V_{IN} falling	V_{IN-OFF}	2.78	2.9	3.05	V
Operating Current	$f_{SW} = 100\text{ kHz}$, $C_{GATE} = 3.3\text{ nF}$, $V_{IN} = 5\text{ V}$	I_{IN-OP}		2.0	2.8	mA
Power Supply Section						
Internal LDO Output Voltage	$V_{IN} = 20\text{ V}$	V_{DD}	5.0	5.25	5.5	V
Dropout Voltage of LDO	$I_{OUT} = 10\text{ mA}$, $V_{IN} = 3.3\text{ V}$	V_{DO}			0.3	V
Drain Voltage Sensing Section						
Comparator Input Offset Voltage	Internal design suggestion	$V_{OSI}^{(4)}$	-1	0	1	mV
Turn-On Threshold Voltage	$R_{DRAIN} = 0\ \Omega$ (includes comparator input offset voltage)	V_{TH-ON}	-250	-200	-150	mV
Slope detection disable criteria		$t_{SLO-DIS}^{(6)}$	53	58	63	μs
Slope detection disable criteria Hysteresis		$t_{SLO-HYS}^{(4)}$		8		μs
Turn on delay	With 50 mV overdrive From V_{TH-ON} to Gate > 1 V	$t_{ON-DLY}^{(4)}$		20		ns
Turn-Off Threshold Tuning Range 1		V_{TH-OFF}	-5		5	mV
Comparator delay for $V_{TH-OFF1}$	With 0mV overdrive From V_{TH-OFF} to Gate = 1 V	$t_{OFF-DLY}^{(4)}$		20		ns
Gate Re-arming threshold	$V_{IN} = 5\text{ V}$ (Typically $0.7V_{DD}$)	V_{TH-ARM}	3.3	3.5	3.7	V
Gate Re-arming time for slope detection		$t_{ARM}^{(4)}$	70	85	100	ns
Slope detection high threshold		$V_{TH-HGH}^{(4)}$	0.4	0.5	0.6	V
Minimum On-Time and Minimum Off-time Section						
Minimum On-Time		t_{ON-MIN}	2.16	2.4	2.64	μs
Minimum On-Time Upper at light load		$t_{ON-MIN-L}$	1.50	1.65	1.80	μs
Minimum t_{ON} cycles during start-up		$N_{ON-MIN-ST}$		3		cycles
Minimum Off-Time		$t_{OFF-MIN-L}^{(5)}$	1.53	1.70	1.87	μs
Minimum Off-Time at light load ($t_s > t_{SLO-DIS}$)		$t_{OFF-MIN-H}^{(5)}$	3.6	4	4.4	μs
Dead Time Control Section						
Dead time self-tuning target	From GATE OFF to V_{DRAIN} rising above 0.5 V	$t_{DEAD}^{(4)}$	170	200	230	ns
DRE Section						
V_{IN} pin DRE function trigger level		$V_{DRE}^{(5)}$	4.68	4.78	4.85	V
Threshold voltage for DRE function		V_{DREI}	1.188	1.200	1.212	V
Drain Pin sinking current period when DRE triggered		$t_{DREI}^{(4)}$	1.2	1.5	1.8	μs
DRE function enable period		t_{DRE-EN}	64	72	80	μs
IDRE re-arm period		t_{RE-ARM}		4		μs
Drain Pin sinking current when DRE triggered		I_{DRE}	50			mA

FAN6250M6X

Table 5. ELECTRICAL CHARACTERISTICS (continued)

$V_{IN} = 5.5\text{ V}$ and $T_A = -40$ to 125°C unless noted otherwise

Parameter	Test Conditions	Symbol	Min	Typ	Max	Unit
Shut-Down Section						
Threshold voltage for Shut-Down function triggered		V_{SD-TH}	0.97	1.00	1.03	V
Shut-Down current source		I_{SD-TH}	44	50	56	μA
Impedance for Shut-Down trigger		Z_{SD-TH}	18.48	20.00	21.68	$\text{k}\Omega$
Denounce Cycles for Shut-Down		$N_{SD-Debounce}$		7		Cycles
Output Driver Section						
Output Voltage Low	$V_{IN} = 6\text{ V}$	V_{OL}			0.25	V
Output Voltage High	$V_{IN} = 6\text{ V}$	V_{OH}	4.9			V
Rise Time	$V_{IN} = 6\text{ V}$, $C_L = 3300\text{ pF}$, GATE = 1 V ~ 4 V	t_R			90	ns
Fall Time	$V_{IN} = 6\text{ V}$, $C_L = 3300\text{ pF}$, GATE = 4 V ~ 1 V	t_F			30	ns

4. Guaranteed by Design.
5. Specification operation temperature range $-5^\circ\text{C} \sim 85^\circ\text{C}$
6. Specification operation temperature range $-5^\circ\text{C} \sim 50^\circ\text{C}$

FAN6250M6X

TYPICAL PERFORMANCE CHARACTERISTICS

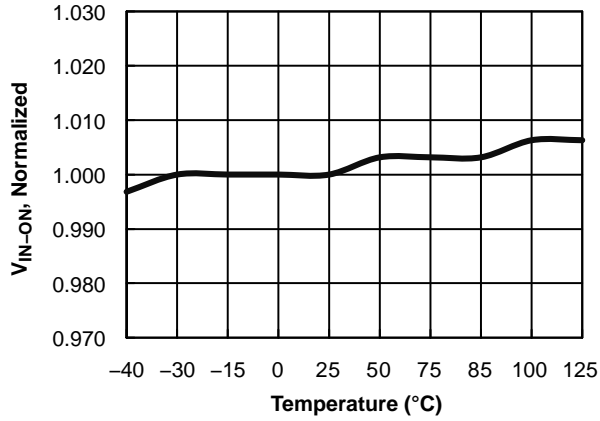

Figure 3. Turn-On Threshold Voltage (V_{IN-ON}) vs. Temperature

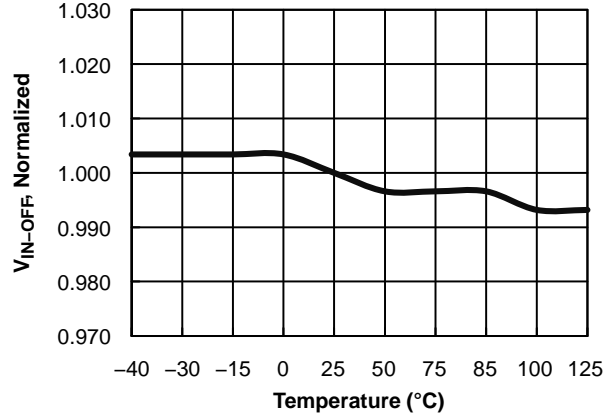

Figure 4. Turn-Off Threshold Voltage (V_{IN-OFF}) vs. Temperature

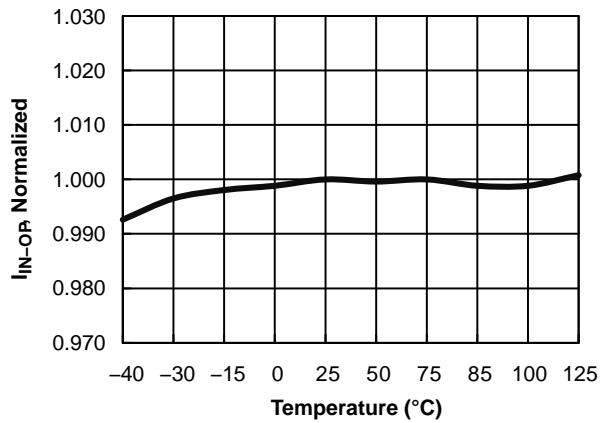

Figure 5. Operating Supply Current (I_{IN-OP}) vs. Temperature

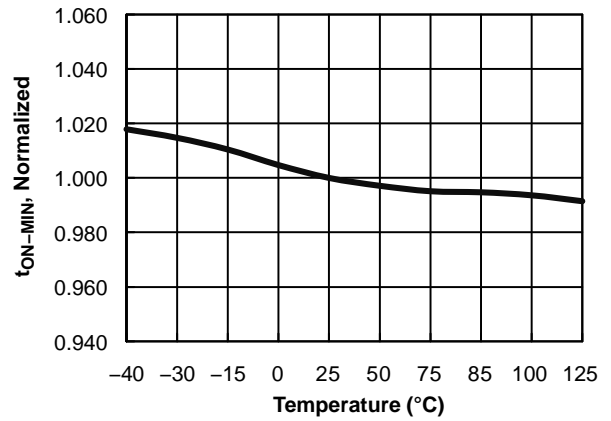

Figure 6. Minimum On Time (t_{ON-MIN}) vs. Temperature

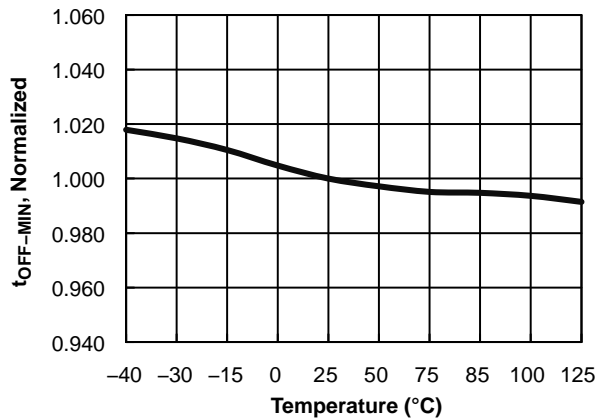

Figure 7. Minimum Gate Turn Off Time (t_{OFF-MIN}) vs. Temperature

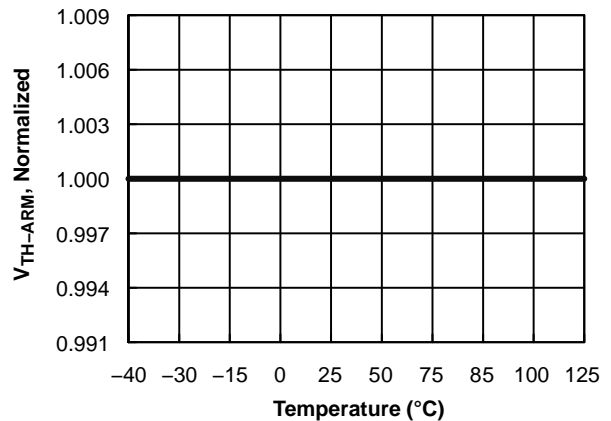

Figure 8. Gate Turn On Threshold Voltage (V_{TH-ARM}) vs. Temperature

FAN6250M6X

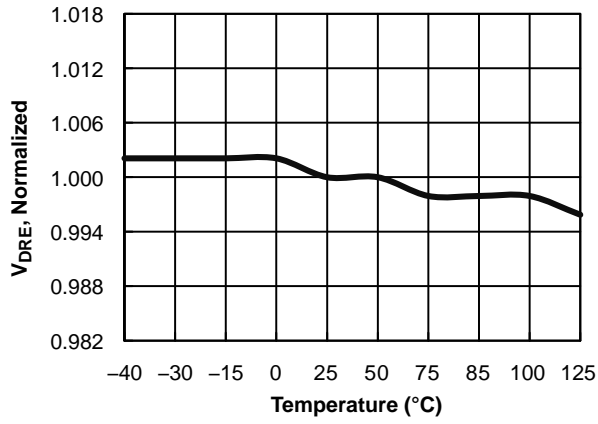

Figure 9. VIN Pin DRE Function Trigger Level (V_{DRE}) vs. Temperature

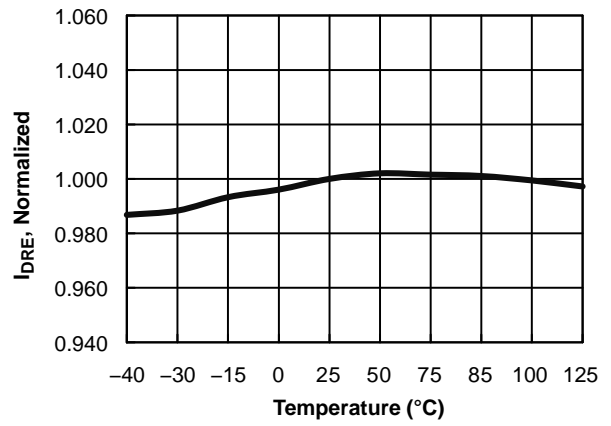

Figure 10. Drain Pin Sinking Current for DRE Triggered (I_{DRE}) vs. Temperature

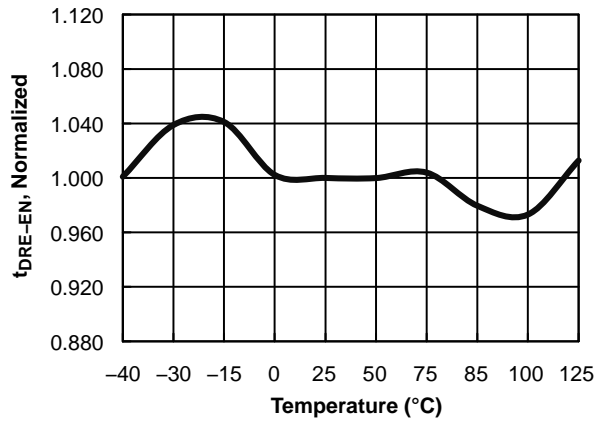

Figure 11. DRE Function Enable Period (t_{DRE-EN}) vs. Temperature

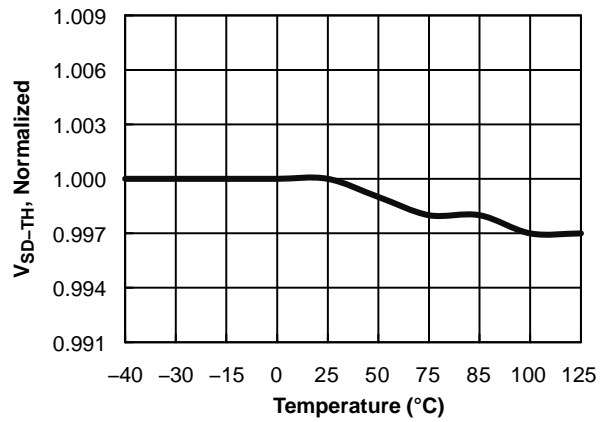

Figure 12. Shut-Down Threshold Voltage (V_{SD-TH}) vs. Temperature

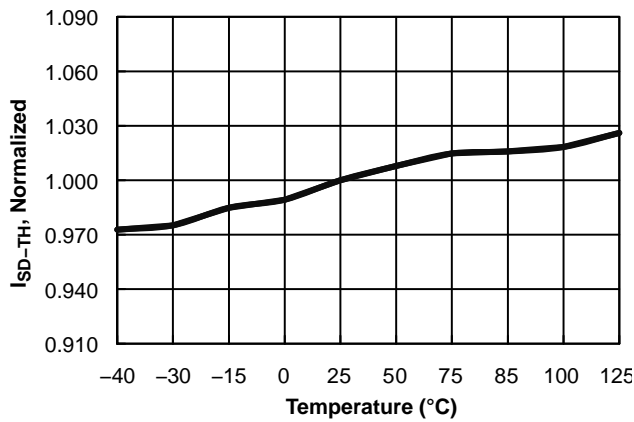

Figure 13. Shut-Down Current Source (I_{SD-TH}) vs. Temperature

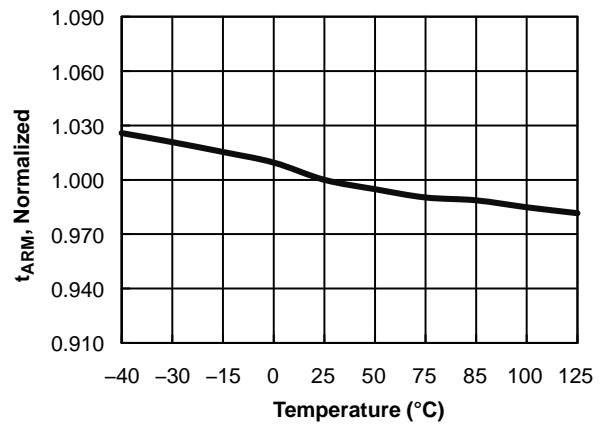

Figure 14. Gate Re-arming Time for Slope Detection (t_{ARM}) vs. Temperature

MECHANICAL CASE OUTLINE

PACKAGE DIMENSIONS

ON Semiconductor®



SOT-23, 6 Lead
CASE 527AJ
ISSUE B



SCALE 2:1

DATE 29 FEB 2012

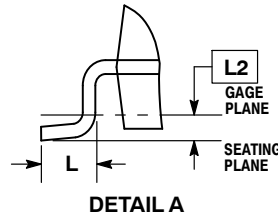
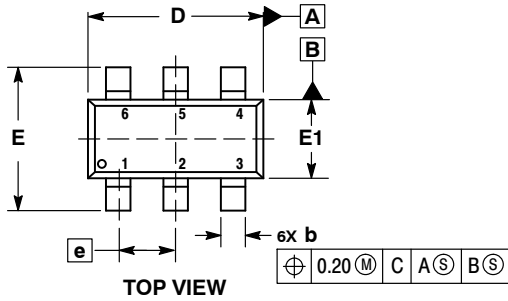

- NOTES:
- DIMENSIONING AND TOLERANCING PER ASME Y14.5M, 1994.
 - CONTROLLING DIMENSION: MILLIMETERS.
 - DATUM C IS THE SEATING PLANE.

MILLIMETERS		
DIM	MIN	MAX
A	---	1.45
A1	0.00	0.15
A2	0.90	1.30
b	0.20	0.50
c	0.08	0.26
D	2.70	3.00
E	2.50	3.10
E1	1.30	1.80
e	0.95 BSC	
L	0.20	0.60
L2	0.25 BSC	

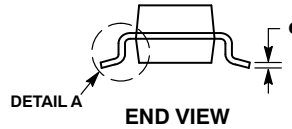
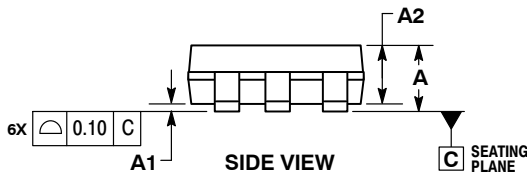

GENERIC MARKING DIAGRAM*

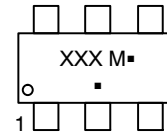

- XXX = Specific Device Code
- M = Date Code
- = Pb-Free Package

(Note: Microdot may be in either location)

*This information is generic. Please refer to device data sheet for actual part marking. Pb-Free indicator, "G" or microdot "▪", may or may not be present.

RECOMMENDED SOLDERING FOOTPRINT*

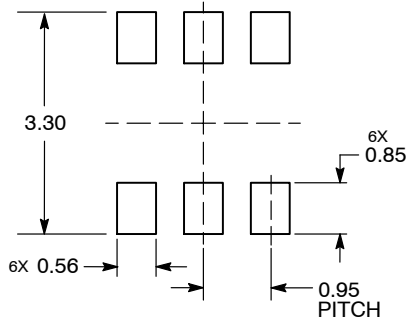

DIMENSIONS: MILLIMETERS

*For additional information on our Pb-Free strategy and soldering details, please download the ON Semiconductor Soldering and Mounting Techniques Reference Manual, SOLDERRM/D.

DOCUMENT NUMBER:	98AON34321E	Electronic versions are uncontrolled except when accessed directly from the Document Repository. Printed versions are uncontrolled except when stamped "CONTROLLED COPY" in red.
DESCRIPTION:	SOT-23, 6 LEAD	PAGE 1 OF 1

ON Semiconductor and ON are trademarks of Semiconductor Components Industries, LLC dba ON Semiconductor or its subsidiaries in the United States and/or other countries. ON Semiconductor reserves the right to make changes without further notice to any products herein. ON Semiconductor makes no warranty, representation or guarantee regarding the suitability of its products for any particular purpose, nor does ON Semiconductor assume any liability arising out of the application or use of any product or circuit, and specifically disclaims any and all liability, including without limitation special, consequential or incidental damages. ON Semiconductor does not convey any license under its patent rights nor the rights of others.

onsemi, **Onsemi**, and other names, marks, and brands are registered and/or common law trademarks of Semiconductor Components Industries, LLC dba "**onsemi**" or its affiliates and/or subsidiaries in the United States and/or other countries. **onsemi** owns the rights to a number of patents, trademarks, copyrights, trade secrets, and other intellectual property. A listing of **onsemi**'s product/patent coverage may be accessed at www.onsemi.com/site/pdf/Patent-Marking.pdf. **onsemi** reserves the right to make changes at any time to any products or information herein, without notice. The information herein is provided "as-is" and **onsemi** makes no warranty, representation or guarantee regarding the accuracy of the information, product features, availability, functionality, or suitability of its products for any particular purpose, nor does **onsemi** assume any liability arising out of the application or use of any product or circuit, and specifically disclaims any and all liability, including without limitation special, consequential or incidental damages. Buyer is responsible for its products and applications using **onsemi** products, including compliance with all laws, regulations and safety requirements or standards, regardless of any support or applications information provided by **onsemi**. "Typical" parameters which may be provided in **onsemi** data sheets and/or specifications can and do vary in different applications and actual performance may vary over time. All operating parameters, including "Typicals" must be validated for each customer application by customer's technical experts. **onsemi** does not convey any license under any of its intellectual property rights nor the rights of others. **onsemi** products are not designed, intended, or authorized for use as a critical component in life support systems or any FDA Class 3 medical devices or medical devices with a same or similar classification in a foreign jurisdiction or any devices intended for implantation in the human body. Should Buyer purchase or use **onsemi** products for any such unintended or unauthorized application, Buyer shall indemnify and hold **onsemi** and its officers, employees, subsidiaries, affiliates, and distributors harmless against all claims, costs, damages, and expenses, and reasonable attorney fees arising out of, directly or indirectly, any claim of personal injury or death associated with such unintended or unauthorized use, even if such claim alleges that **onsemi** was negligent regarding the design or manufacture of the part. **onsemi** is an Equal Opportunity/Affirmative Action Employer. This literature is subject to all applicable copyright laws and is not for resale in any manner.

ADDITIONAL INFORMATION

TECHNICAL PUBLICATIONS:

Technical Library: www.onsemi.com/design/resources/technical-documentation
onsemi Website: www.onsemi.com

ONLINE SUPPORT: www.onsemi.com/support

For additional information, please contact your local Sales Representative at www.onsemi.com/support/sales