

μA79M00 SERIES NEGATIVE-VOLTAGE REGULATORS

SLVS060K – JUNE 1976 – REVISED APRIL 2005

- 3-Terminal Regulators
- Output Current Up To 500 mA
- No External Components
- High Power-Dissipation Capability
- Internal Short-Circuit Current Limiting
- Output Transistor Safe-Area Compensation

μA79M05 . . . KC (TO-220) PACKAGE
(TOP VIEW)

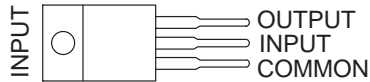

μA79M05 . . . KCS (TO-220) PACKAGE
(TOP VIEW)

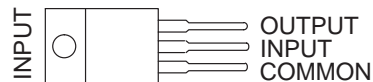

μA79M05, μA79M08 . . . KTP PACKAGE
(TOP VIEW)

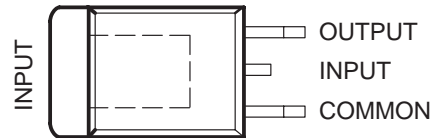

description/ordering information

This series of fixed-negative-voltage integrated-circuit voltage regulators is designed to complement the μA78M00 series in a wide range of applications. These applications include on-card regulation for elimination of noise and distribution problems associated with single-point regulation. Each of these regulators delivers up to 500 mA of output current. The internal current-limiting and thermal-shutdown features of these regulators essentially make them immune to overload. In addition to use as fixed-voltage regulators, these devices can be used with external components to obtain adjustable output voltages and currents, and also as the power-pass element in precision regulators.

ORDERING INFORMATION

T_J	$V_O(NOM)$ (V)	PACKAGE†		ORDERABLE PART NUMBER	TOP-SIDE MARKING
0°C to 125°C	-5	PowerFLEX™ (KTP)	Reel of 3000	μA79M05CKTPR	μA79M05C
		TO-220 (KC)	Tube of 50	μA79M05CKC	μA79M05C
		TO-220, short shoulder (KCS)	Tube of 20	μA79M05CKCS	
	-8	PowerFLEX (KTP)	Reel of 3000	μA79M08CKTPR	μA79M08C

† Package drawings, standard packing quantities, thermal data, symbolization, and PCB design guidelines are available at www.ti.com/sc/package.



Please be aware that an important notice concerning availability, standard warranty, and use in critical applications of Texas Instruments semiconductor products and disclaimers thereto appears at the end of this data sheet.

PowerFLEX is a trademark of Texas Instruments.

PRODUCTION DATA information is current as of publication date. Products conform to specifications per the terms of Texas Instruments standard warranty. Production processing does not necessarily include testing of all parameters.



POST OFFICE BOX 655303 • DALLAS, TEXAS 75265

Copyright © 2005, Texas Instruments Incorporated

μA79M00 SERIES NEGATIVE-VOLTAGE REGULATORS

SLVS060K – JUNE 1976 – REVISED APRIL 2005

schematic

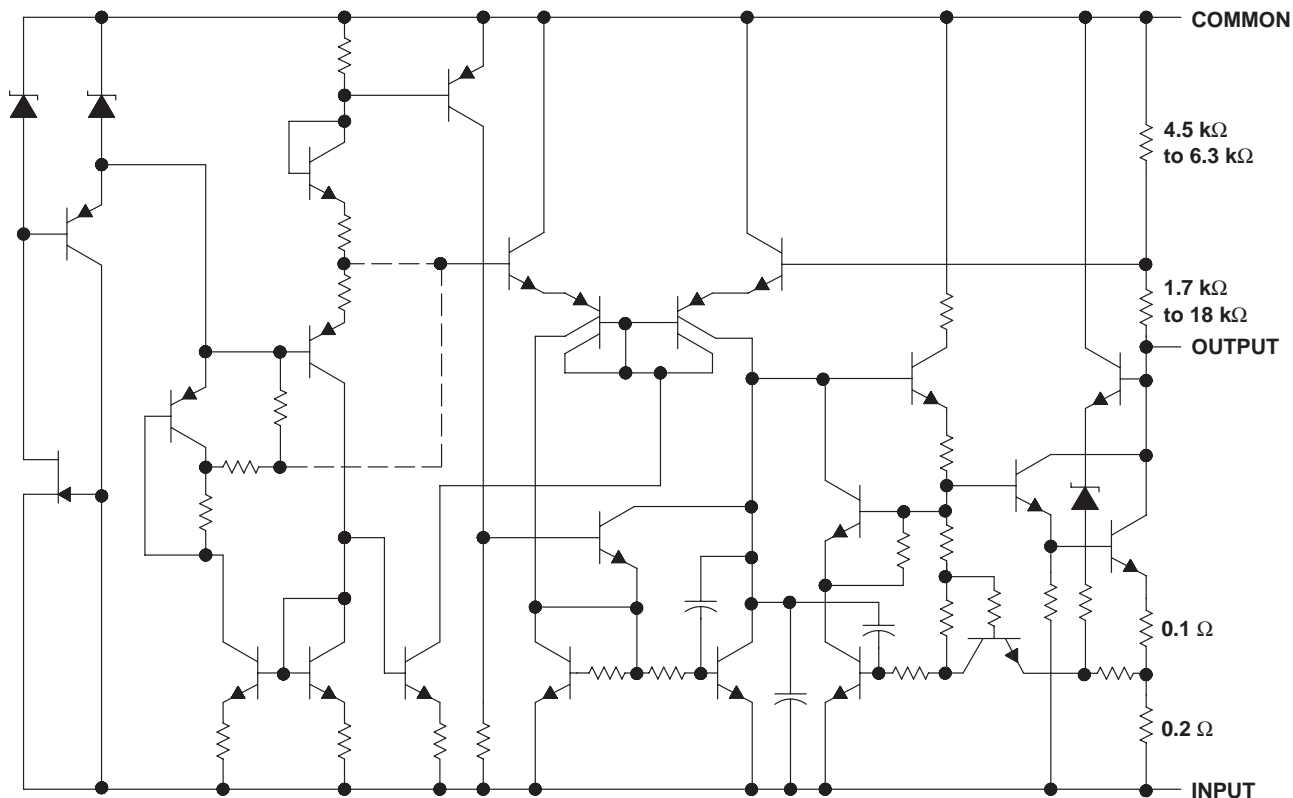

Resistor values shown are nominal.

absolute maximum ratings over virtual junction temperature range (unless otherwise noted)†

Input voltage, V_I	35 V
Operating virtual junction temperature, T_J	150°C
Lead temperature 1,6 mm (1/16 inch) from case for 10 seconds	260°C
Storage temperature range, T_{stg}	-65°C to 150°C

† Stresses beyond those listed under “absolute maximum ratings” may cause permanent damage to the device. These are stress ratings only, and functional operation of the device at these or any other conditions beyond those indicated under “recommended operating conditions” is not implied. Exposure to absolute-maximum-rated conditions for extended periods may affect device reliability.

package thermal data (see Note 1)

PACKAGE	BOARD	θ_{JC}	θ_{JA}	θ_{JP}^\ddagger
PowerFLEX (KTP)	High K, JESD 51-5	19°C/W	28°C/W	1.4°C/W
TO-220 (KC/KCS)	High K, JESD 51-5	17°C/W	19°C/W	3°C/W

NOTE 1: Maximum power dissipation is a function of $T_J(\max)$, θ_{JA} , and T_A . The maximum allowable power dissipation at any allowable ambient temperature is $P_D = (T_J(\max) - T_A)/\theta_{JA}$. Operating at the absolute maximum T_J of 150°C can affect reliability.

‡ For packages with exposed thermal pads, such as QFN, PowerPAD, or PowerFLEX, θ_{JP} is defined as the thermal resistance between the die junction and the bottom of the exposed pad.

μA79M00 SERIES NEGATIVE-VOLTAGE REGULATORS

SLVS060K – JUNE 1976 – REVISED APRIL 2005

recommended operating conditions

		MIN	MAX	UNIT	
V_I	Input voltage	μA79M05C	-7	-25	V
		μA79M08C	-10.5	-25	
I_O	Output current		500	mA	
T_J	Operating virtual junction temperature	0	125	°C	

electrical characteristics at specified virtual junction temperature, $V_I = -10$ V, $I_O = 350$ mA, $T_J = 25^\circ$ C (unless otherwise noted)

PARAMETER	TEST CONDITIONS†	μA79M05C			UNIT
		MIN	TYP	MAX	
Output voltage	$V_I = -7$ V to -25 V, $I_O = 5$ mA to 350 mA $T_J = 0^\circ$ C to 125° C	-4.8	-5	-5.2	V
		-4.75		-5.25	
Input voltage regulation	$V_I = -7$ V to -25 V		7	50	mV
	$V_I = -8$ V to -18 V		3	30	
Ripple rejection	$V_I = -8$ V to -18 V, $f = 120$ Hz $I_O = 100$ mA, $T_J = 0^\circ$ C to 125° C $I_O = 300$ mA	50			dB
		54	60		
Output voltage regulation	$I_O = 5$ mA to 500 mA		75	100	mV
	$I_O = 5$ mA to 350 mA		50		
Temperature coefficient of output voltage	$I_O = 5$ mA, $T_J = 0^\circ$ C to 125° C		-0.4		mV/°C
Output noise voltage	$f = 10$ Hz to 100 kHz		125		μV
Dropout voltage			1.1		V
Bias current			1	2	mA
Bias current change	$V_I = -8$ V to -18 V, $T_J = 0^\circ$ C to 125° C			0.4	mA
	$I_O = 5$ mA to 350 mA, $T_J = 0^\circ$ C to 125° C			0.4	
Short-circuit output current	$V_I = -30$ V		140		mA
Peak output current			0.65		A

† Pulse-testing techniques maintain T_J as close to T_A as possible. Thermal effects must be taken into account separately. All characteristics are measured with a 2-μF capacitor across the input and a 1-μF capacitor across the output.

μA79M00 SERIES NEGATIVE-VOLTAGE REGULATORS

SLVS060K – JUNE 1976 – REVISED APRIL 2005

electrical characteristics at specified virtual junction temperature, $V_I = -19\text{ V}$, $I_O = 350\text{ mA}$, $T_J = 25^\circ\text{C}$
(unless otherwise noted)

PARAMETER	TEST CONDITION†	μA79M08C			UNIT
		MIN	TYP	MAX	
Output voltage	$V_I = -10.5\text{ V to }-25\text{ V}$, $I_O = 5\text{ mA to }350\text{ mA}$	-7.7	-8	-8.3	V
	$T_J = 0^\circ\text{C to }125^\circ\text{C}$	-7.6		-8.4	
Input voltage regulation	$V_I = -10.5\text{ V to }-25\text{ V}$		8	80	mV
	$V_I = -11\text{ V to }-21\text{ V}$		4	50	
Ripple rejection	$V_I = -11.5\text{ V to }-21.5\text{ V}$, $f = 120\text{ Hz}$		50		dB
	$I_O = 100\text{ mA}$, $T_J = 0^\circ\text{C to }125^\circ\text{C}$ $I_O = 300\text{ mA}$	54	59		
Output voltage regulation	$I_O = 5\text{ mA to }500\text{ mA}$		90	160	mV
	$I_O = 5\text{ mA to }350\text{ mA}$		60		
Temperature coefficient of output voltage	$I_O = 5\text{ mA}$, $T_J = 0^\circ\text{C to }125^\circ\text{C}$		-0.6		mV/°C
Output noise voltage	$f = 10\text{ Hz to }100\text{ kHz}$		200		μV
Dropout voltage	$I_O = 5\text{ mA}$		1.1		V
Bias current			1	2	mA
Bias current change	$V_I = -10.5\text{ V to }-25\text{ V}$, $T_J = 0^\circ\text{C to }125^\circ\text{C}$			0.4	mA
	$I_O = 5\text{ mA to }350\text{ mA}$, $T_J = 0^\circ\text{C to }125^\circ\text{C}$			0.4	
Short-circuit output current	$V_I = -30\text{ V}$		140		mA
Peak output current			0.65		A

† Pulse-testing techniques maintain T_J as close to T_A as possible. Thermal effects must be taken into account separately. All characteristics are measured with a 2-μF capacitor across the input and a 1-μF capacitor across the output.

PACKAGING INFORMATION

Orderable Device	Status (1)	Package Type	Package Drawing	Pins	Package Qty	Eco Plan (2)	Lead finish/ Ball material (6)	MSL Peak Temp (3)	Op Temp (°C)	Device Marking (4/5)	Samples
UA79M05CKCS	LIFEBUY	TO-220	KCS	3	50	RoHS & Green	SN	N / A for Pkg Type	0 to 125	UA79M05C	
UA79M05CKVURG3	LIFEBUY	TO-252	KVU	3	2500	RoHS & Green	SN	Level-3-260C-168 HR	0 to 125	79M05C	
UA79M08CKVURG3	LIFEBUY	TO-252	KVU	3	2500	RoHS & Green	SN	Level-3-260C-168 HR	0 to 125	79M08C	

(1) The marketing status values are defined as follows:

ACTIVE: Product device recommended for new designs.

LIFEBUY: TI has announced that the device will be discontinued, and a lifetime-buy period is in effect.

NRND: Not recommended for new designs. Device is in production to support existing customers, but TI does not recommend using this part in a new design.

PREVIEW: Device has been announced but is not in production. Samples may or may not be available.

OBsolete: TI has discontinued the production of the device.

(2) **RoHS:** TI defines "RoHS" to mean semiconductor products that are compliant with the current EU RoHS requirements for all 10 RoHS substances, including the requirement that RoHS substance do not exceed 0.1% by weight in homogeneous materials. Where designed to be soldered at high temperatures, "RoHS" products are suitable for use in specified lead-free processes. TI may reference these types of products as "Pb-Free".

RoHS Exempt: TI defines "RoHS Exempt" to mean products that contain lead but are compliant with EU RoHS pursuant to a specific EU RoHS exemption.

Green: TI defines "Green" to mean the content of Chlorine (Cl) and Bromine (Br) based flame retardants meet JS709B low halogen requirements of <=1000ppm threshold. Antimony trioxide based flame retardants must also meet the <=1000ppm threshold requirement.

(3) MSL, Peak Temp. - The Moisture Sensitivity Level rating according to the JEDEC industry standard classifications, and peak solder temperature.

(4) There may be additional marking, which relates to the logo, the lot trace code information, or the environmental category on the device.

(5) Multiple Device Markings will be inside parentheses. Only one Device Marking contained in parentheses and separated by a "~" will appear on a device. If a line is indented then it is a continuation of the previous line and the two combined represent the entire Device Marking for that device.

(6) Lead finish/Ball material - Orderable Devices may have multiple material finish options. Finish options are separated by a vertical ruled line. Lead finish/Ball material values may wrap to two lines if the finish value exceeds the maximum column width.

Important Information and Disclaimer:The information provided on this page represents TI's knowledge and belief as of the date that it is provided. TI bases its knowledge and belief on information provided by third parties, and makes no representation or warranty as to the accuracy of such information. Efforts are underway to better integrate information from third parties. TI has taken and continues to take reasonable steps to provide representative and accurate information but may not have conducted destructive testing or chemical analysis on incoming materials and chemicals. TI and TI suppliers consider certain information to be proprietary, and thus CAS numbers and other limited information may not be available for release.

In no event shall TI's liability arising out of such information exceed the total purchase price of the TI part(s) at issue in this document sold by TI to Customer on an annual basis.

TAPE AND REEL INFORMATION

QUADRANT ASSIGNMENTS FOR PIN 1 ORIENTATION IN TAPE

*All dimensions are nominal

Device	Package Type	Package Drawing	Pins	SPQ	Reel Diameter (mm)	Reel Width W1 (mm)	A0 (mm)	B0 (mm)	K0 (mm)	P1 (mm)	W (mm)	Pin1 Quadrant
UA79M05CKVURG3	TO-252	KVU	3	2500	330.0	16.4	6.9	10.5	2.7	8.0	16.0	Q2
UA79M08CKVURG3	TO-252	KVU	3	2500	330.0	16.4	6.9	10.5	2.7	8.0	16.0	Q2

TAPE AND REEL BOX DIMENSIONS

*All dimensions are nominal

Device	Package Type	Package Drawing	Pins	SPQ	Length (mm)	Width (mm)	Height (mm)
UA79M05CKVURG3	TO-252	KVU	3	2500	340.0	340.0	38.0
UA79M08CKVURG3	TO-252	KVU	3	2500	340.0	340.0	38.0

TUBE



*All dimensions are nominal

Device	Package Name	Package Type	Pins	SPQ	L (mm)	W (mm)	T (μm)	B (mm)
UA79M05CKCS	KCS	TO-220	3	50	532	34.1	700	9.6

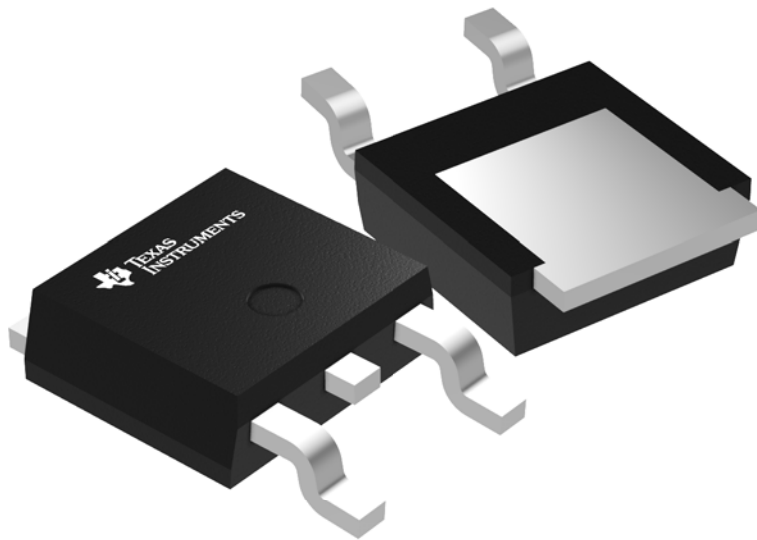

Images above are just a representation of the package family, actual package may vary.
Refer to the product data sheet for package details.



PACKAGE OUTLINE

KVVU0003A

TO-252 - 2.52 mm max height

TO-252

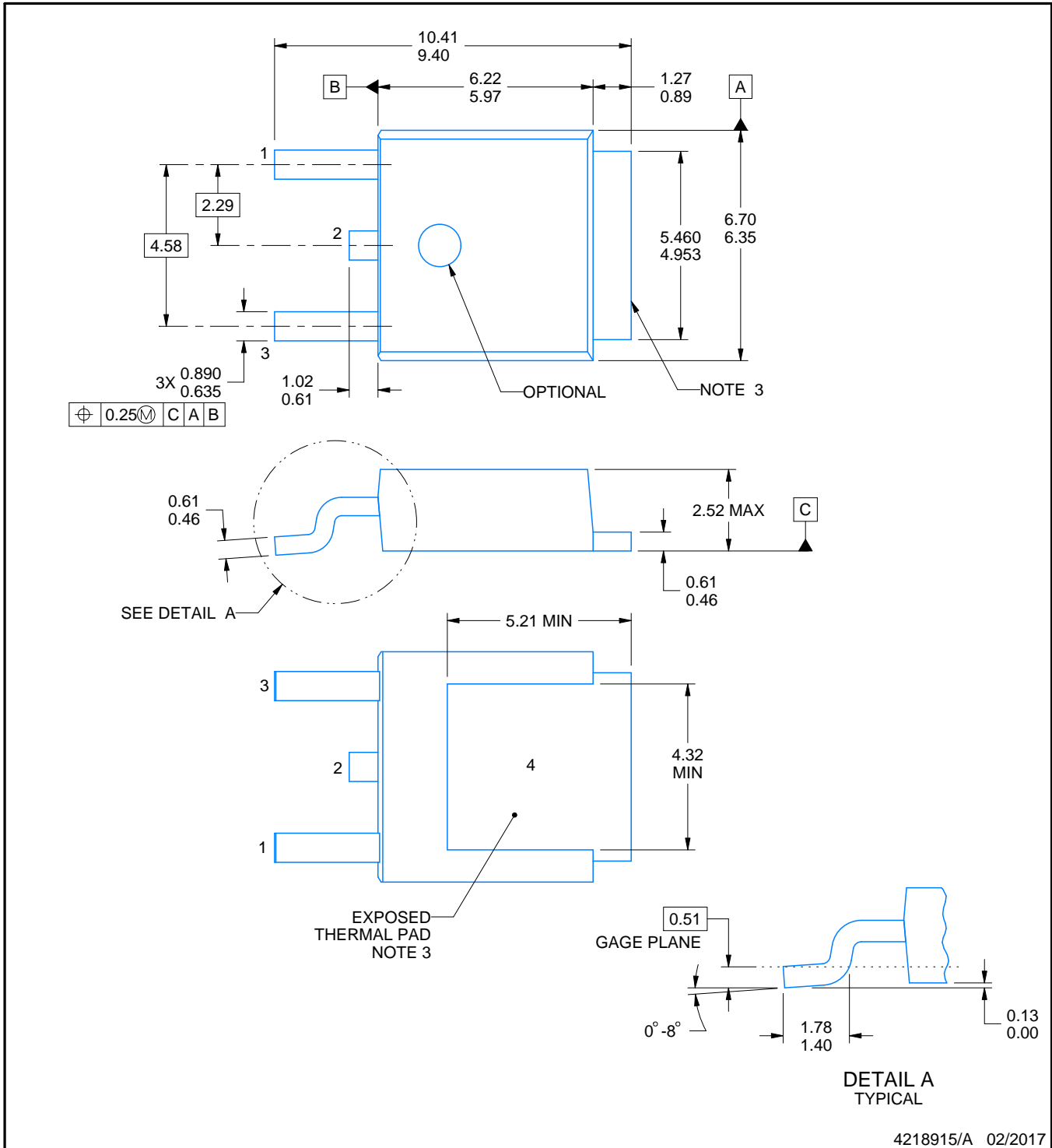

4218915/A 02/2017

NOTES:

1. All linear dimensions are in millimeters. Any dimensions in parenthesis are for reference only. Dimensioning and tolerancing per ASME Y14.5M.
2. This drawing is subject to change without notice.
3. Shape may vary per different assembly sites.
4. Reference JEDEC registration TO-252.

EXAMPLE BOARD LAYOUT

KVU0003A

TO-252 - 2.52 mm max height

TO-252

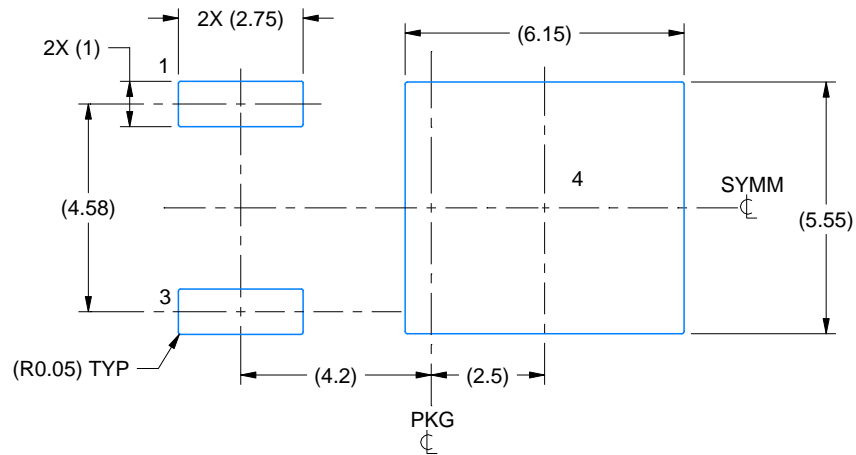

LAND PATTERN EXAMPLE
EXPOSED METAL SHOWN
SCALE:6X

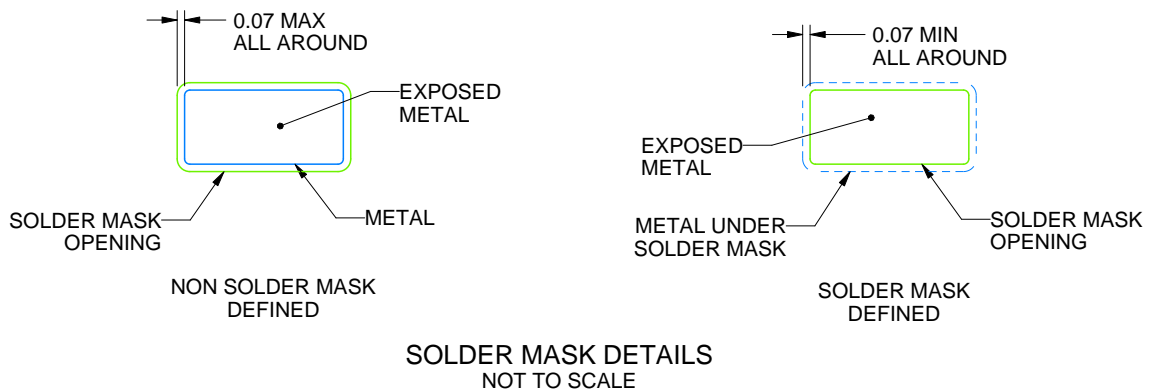

SOLDER MASK DETAILS
NOT TO SCALE

4218915/A 02/2017

NOTES: (continued)

5. This package is designed to be soldered to a thermal pad on the board. For more information, see Texas Instruments literature numbers SLMA002(www.ti.com/lit/slm002) and SLMA004 (www.ti.com/lit/slma004).
6. Vias are optional depending on application, refer to device data sheet. It is recommended that vias under paste be filled, plugged or tented.

EXAMPLE STENCIL DESIGN

KVU0003A

TO-252 - 2.52 mm max height

TO-252

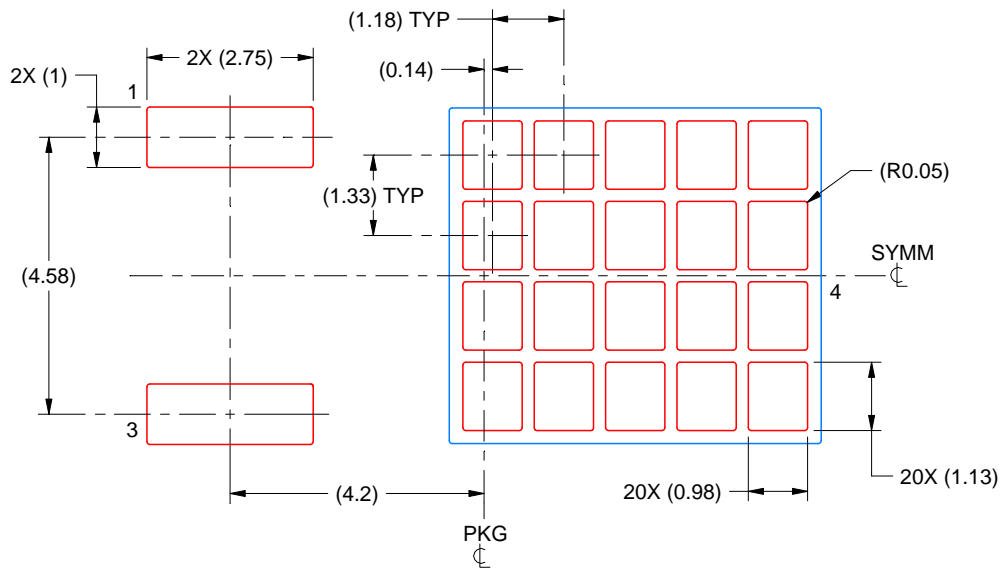

SOLDER PASTE EXAMPLE
BASED ON 0.125 mm THICK STENCIL

EXPOSED PAD
65% PRINTED SOLDER COVERAGE BY AREA
SCALE:8X

4218915/A 02/2017

NOTES: (continued)

7. Laser cutting apertures with trapezoidal walls and rounded corners may offer better paste release. IPC-7525 may have alternate design recommendations.
8. Board assembly site may have different recommendations for stencil design.

EXAMPLE BOARD LAYOUT

KCS0003B

TO-220 - 19.65 mm max height

TO-220

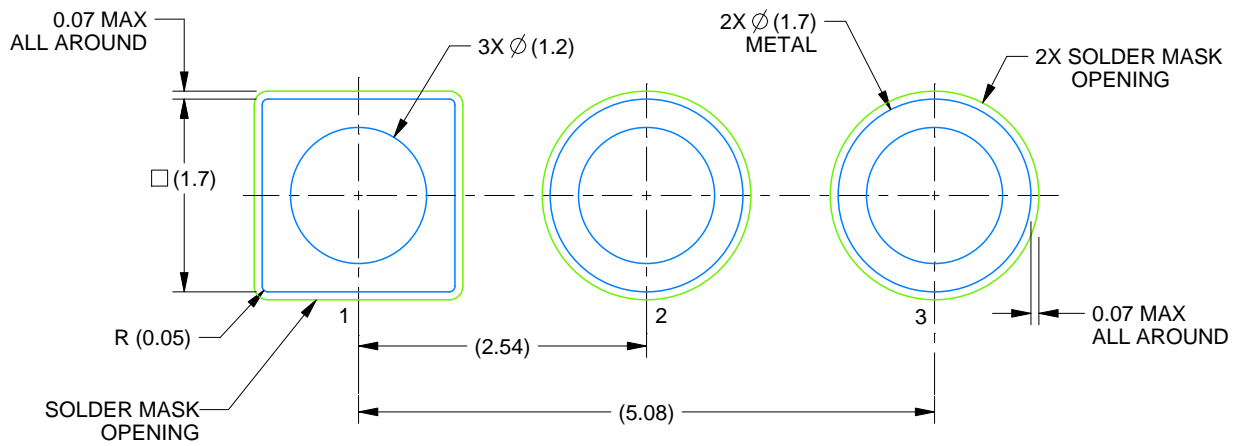

LAND PATTERN EXAMPLE
NON-SOLDER MASK DEFINED
SCALE:15X

4222214/B 08/2018

IMPORTANT NOTICE AND DISCLAIMER

TI PROVIDES TECHNICAL AND RELIABILITY DATA (INCLUDING DATA SHEETS), DESIGN RESOURCES (INCLUDING REFERENCE DESIGNS), APPLICATION OR OTHER DESIGN ADVICE, WEB TOOLS, SAFETY INFORMATION, AND OTHER RESOURCES "AS IS" AND WITH ALL FAULTS, AND DISCLAIMS ALL WARRANTIES, EXPRESS AND IMPLIED, INCLUDING WITHOUT LIMITATION ANY IMPLIED WARRANTIES OF MERCHANTABILITY, FITNESS FOR A PARTICULAR PURPOSE OR NON-INFRINGEMENT OF THIRD PARTY INTELLECTUAL PROPERTY RIGHTS.

These resources are intended for skilled developers designing with TI products. You are solely responsible for (1) selecting the appropriate TI products for your application, (2) designing, validating and testing your application, and (3) ensuring your application meets applicable standards, and any other safety, security, regulatory or other requirements.

These resources are subject to change without notice. TI grants you permission to use these resources only for development of an application that uses the TI products described in the resource. Other reproduction and display of these resources is prohibited. No license is granted to any other TI intellectual property right or to any third party intellectual property right. TI disclaims responsibility for, and you will fully indemnify TI and its representatives against, any claims, damages, costs, losses, and liabilities arising out of your use of these resources.

TI's products are provided subject to [TI's Terms of Sale](#) or other applicable terms available either on [ti.com](https://www.ti.com) or provided in conjunction with such TI products. TI's provision of these resources does not expand or otherwise alter TI's applicable warranties or warranty disclaimers for TI products.

TI objects to and rejects any additional or different terms you may have proposed.

Mailing Address: Texas Instruments, Post Office Box 655303, Dallas, Texas 75265
Copyright © 2023, Texas Instruments Incorporated